



## Lead Screws, Ball Screws and Ball Splines



*Linear Motion. Optimized.™*

## Thomson – the Choice for Optimized Motion Solutions

Often the ideal design solution is not about finding the fastest, sturdiest, most accurate or even the least expensive option. Rather, the ideal solution is the optimal balance of performance, life and cost.

### The Best Positioned Supplier of Mechanical Motion Technology

Thomson has several advantages that make us the supplier of choice for motion control technology.

- Thomson provides the broadest standard product offering of mechanical motion technologies in the industry.
- Modified versions of standard product or white sheet design solutions are routine for us.
- Choose Thomson and gain access to over 70 years of global application experience in industries including packaging, factory automation, material handling, medical, clean energy, printing, automotive, machine tool, aerospace and defense.
- As part of Danaher Corporation, we are financially strong and unique in our ability to bring together control, drive, motor, power transmission and precision linear motion technologies.

### A Name You Can Trust

A wealth of product and application information as well as 3D models, software tools, our distributor locator and global contact information is available at [www.thomsonlinear.com](http://www.thomsonlinear.com). For assistance, contact your local sales office (contact information listed on the back of catalog). Talk to us early in the design process to see how Thomson can help identify the optimal balance of performance, life and cost for your next application. And, call us or any of our 2000+ distribution partners around the world for fast delivery of replacement parts.

### The Danaher Business System

The Danaher Business System (DBS) was established to increase the value we bring to customers. It is a mature and successful set of tools we use daily to continually improve manufacturing operations and product development processes. DBS is based on the principles of Kaizen which continuously and aggressively eliminate waste in every aspect of our business. DBS focuses the entire organization on achieving breakthrough results that create competitive advantages in quality, delivery and performance – advantages that are passed on to you. Through these advantages Thomson is able to provide you faster times to market as well as unsurpassed product selection, service, reliability and productivity.

### Local Support Around the Globe

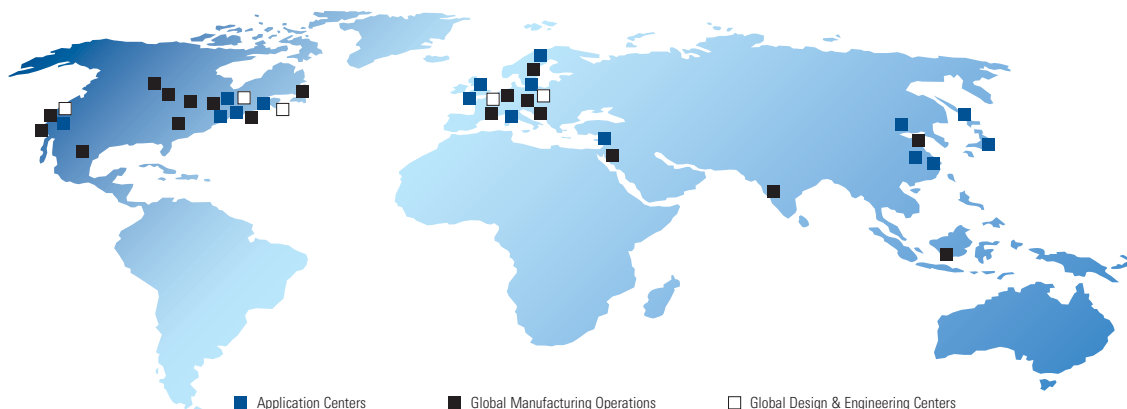

## A World Class Heritage Serves as Our Foundation

**The very best of the Thomson, Warner, BSA and Neff ball and lead screw lines are now combined to form the most complete product offering in the industry**

Thomson has a long history of manufacturing quality lead screws and ball screws. Our roots are planted in four separate companies that held strong and definitive footholds in the market. Those companies — **Ball Screws & Actuators Co, Warner Linear, Thomson Industries, and Neff Automation** — now form the nucleus of the Thomson ball screw and lead screw business.

Founded in 1971, the **Ball Screws & Actuators Co. (BSA)** was a pioneer and leader in precision plastic nut, lead screw and ball screw technologies for linear motion applications. Their custom and off-the-shelf solutions featured many patented products, including their ActiveCAM technology for eliminating backlash while increasing performance and wear life. BSA joined Danaher Motion in 1996 and brought a wealth of experience and knowledge to the ball and lead screw team.

Tollo Linear was founded in 1982 and manufactured linear actuators, linear drive units and handling components under a variety of trademarked product names. Its products were sold to direct customers, OEM manufacturers, and system houses throughout the world. In 1989, Tollo Linear was purchased by Warner Electric and the new division became known as **Warner Linear**. After substantial growth in the industry, Warner Linear, including its superior ball screw product line, was acquired by Danaher Motion in 2000.

**Thomson Industries** was the leading U.S. producer of linear motion control products, including linear actuators, ball screws, linear bearings and rails, and precision gearboxes. Its products were found in a range of precision motion applications in the medical, industrial, aerospace and mobile off-highway markets. In October 2002, Danaher Motion acquired Thomson Industries and retained the strong Thomson brand name.

**Neff Automation** was founded in 1905 and has since been a leading manufacturer of industrial products for linear motion applications. In the past four decades Neff has become a market leader in high precision rolled ball screws, providing solutions for customers all across the globe. In 2004 Neff Automation joined Danaher Motion, bringing high quality products, manufacturing expertise, and deep application knowledge to the ball and lead screw team.

The current lead screw and ball screw offerings of Danaher Motion combine the quality, strength and expertise of the distinct products and professionals at these four companies under the **Thomson** name. The products set the solid foundation for the broad range of standard and custom lead and ball screws available today. If past history and experience is an indication of what the future holds, Thomson is significantly poised to remain a prominent leader and pioneer in the ball screw and lead screw industry.

Ball Screws and Actuators (BSA)  
Warner Linear Ball Screws  
Thomson Industries  
Neff Automation

**THOMSON™**

**Thomson BSA Lead Screws & Supernuts**  
**Precision Rolled Ball Screws — Inch Series**  
**Precision Plus Ball Screws — Inch & Metric Series**  
**Miniature Rolled Ball Screws — Metric Series**  
**Thomson NEFF Rolled Ball Screws — Metric Series**  
**Precision Rolled Ball Splines — Inch Series**

|   |     |
|---|-----|
| <b>Company Overview</b> .....   | 3   |
| <b>Product Overview</b> .....   | 5   |
| <b>Request for Quote</b> .....  | 6   |
| <b>Application Analysis Worksheet</b> .....                                 | 7   |
| <b>Technology Comparison</b> .....  | 8   |
| <b>Lead Screws</b>  |     |
| Product Overview .....  | 12  |
| Advanced Anti-Backlash Supernuts .....                                      | 15  |
| Flange Mount Supernuts .....  | 26  |
| Thread Mount Supernuts .....  | 29  |
| Thread Mount Bronze Nuts .....  | 32  |
| Standard Mounting Flanges .....   | 34  |
| Stainless Steel Lead Screws .....   | 35  |
| V-Thread Screws .....   | 38  |
| <b>Ball Screws — Inch Series</b>  |     |
| Product Overview .....  | 42  |
| Precision Rolled Ball Screws — Inch Series .....                            | 46  |
| Visual Product Reference — Precision Rolled Ball Screws — Inch Series ..... | 91  |
| Precision Plus Ball Screws — Inch Series .....                              | 101 |
| <b>Ball Screws — Metric Series</b>  |     |
| Product Overview .....  | 106 |
| Miniature Rolled Ball Screws — Metric Series .....                          | 113 |
| Thomson NEFF Rolled Ball Screws — Metric Series .....                       | 119 |
| Precision Plus Ball Screws — Metric Series .....                            | 135 |
| <b>Ball Splines</b>   |     |
| Precision Rolled Ball Splines — Inch Series .....                           | 139 |
| <b>Bearing Supports/End Machining</b>                                       |     |
| Product Overview .....  | 144 |
| Quick Install Assemblies .....  | 147 |
| Bearing Supports/End Machining .....  | 154 |
| <b>Engineering</b>  |     |
| Lead Screws .....   | 181 |
| Ball Screws — Inch Series .....   | 189 |
| Ball Screws — Metric Series .....   | 203 |
| Ball Splines .....  | 213 |
| Installation .....  | 217 |
| Maintenance and Service .....   | 226 |
| Lubrication .....   | 233 |
| Glossary/Formulas .....   | 234 |

## Product Overview

### THOMSON BSA PRECISION LEAD SCREWS AND SUPERNUTS®

Offering smooth, precise, cost effective positioning, this is the “just right” solution for your application.

Thomson BSA precision lead screws are an excellent economical solution for your linear motion requirements. For more than 30 years, Thomson BSA has designed and manufactured the highest quality lead screw assemblies in the industry. Our precision rolling machines ensure accurate positioning to 0.003 in/ft and our PTFE coating process produces assemblies that have less drag torque and last longer. All of our standard plastic nut assemblies use an internally lubricated Acetal — providing excellent lubricity and wear resistance with or without additional lubrication. With the introduction of our new unique patent pending zero backlash designs, Thomson BSA provides assemblies with high axial stiffness, zero backlash and the absolute minimum drag torque to reduce motor requirements. These designs produce products that cost less, perform better and last longer. Both designs automatically adjust for wear insuring zero backlash for the life of the nut. For significantly higher loads, standard bronze nuts are available.

### THOMSON BALL SCREWS — INCH SERIES

The most comprehensive imperial-based ball screw product offering in the industry.

Thomson is the market leader in inch-dimensioned ball screws, featuring the very best of the ball screw product offerings of BSA, Warner Linear, and Thomson Industries, integrated into a single, comprehensive product offering. Our **Precision Rolled Ball Screws** come in a full range of diameters, leads, and ball nut configurations, in either preloaded or non-preloaded types, all in industry-standard envelopes. They provide dependable accuracy and repeatability at an economical price. Thomson also offers inch-based **Precision Plus Ball Screws**, which provide higher-level precision for immediate improvement in machine performance. All Thomson ball screws feature a Gothic arch ball groove geometry that extends service life, reduces lash, and optimizes stiffness in preloaded assemblies. This unique design feature also eliminates skidding, increases positioning accuracy, and maximizes travel life.

### THOMSON BALL SCREWS — METRIC SERIES

Superior performance for today’s most stringent positioning requirements.

Thomson offers a full range of internal return metric ball screw products, featuring four distinct product families. **Miniature Rolled Ball Screw Assemblies** are an efficient, cost-effective solution in a small envelope. Ball screw assemblies range from 4mm to 14mm in diameter, with standard lead accuracies of 52 microns/300mm. **Thomson NEFF Rolled Ball Screw Assemblies** are designed and manufactured to provide high level performance at an affordable price. Ball screws are manufactured using Thomson’s patented, German-engineered Precision Screw Forming (PSF) Technology, which provides high accuracy (23 microns/300mm standard) with the manufacturing efficiency of rolled processes. **Thomson NEFF Rolled Ball Screw Assemblies** are available in a wide range of diameters, leads and nut styles — all designed to provide quiet, smooth running, efficient performance. Ball nuts include one of three unique ball return systems providing perfect guidance, low wear, and smooth running performance. **Precision Plus Ball Screw Assemblies** are our highest precision product, with standard lead accuracies of 12 microns/300mm. These ball screw assemblies feature our FL-style ball nut, designed to provide high repeatability and high stiffness for the most demanding ball screw applications.

### THOMSON PRECISION BALL SPLINES

High reliability, speed, and versatility for tough applications with torque loads.

Thomson precision ball splines provide high speed, anti-friction linear motion under high torsional loads. They have high reliability under varying operating conditions and predictable life expectancy. They resist radial displacement resulting from torque loads, and require smaller forces to achieve axial displacement of the spline member while transmitting torque. Ball splines have application versatility such as helicopter rotor couplings; translating drive shaft couplings, non-swiveling telescoping struts; honing machine and drill press spindles, workhead and table ways, and remote and robot handling machines.



Lead Screws



Ball Screws - Inch Series



Ball Screws - Metric Series



Ball Splines

Bearing Supports/  
End Machining

Engineering

Date: \_\_\_\_ / \_\_\_\_ / \_\_\_\_

## Request for Quote

Use this form if you have already selected a product. We will respond within four hours.

### 1. Information

|                     |  |                    |  |
|---------------------|--|--------------------|--|
| <b>Name</b>         |  | <b>Title/Dept.</b> |  |
| <b>Company Name</b> |  |                    |  |
| <b>Address</b>      |  |                    |  |
| <b>Phone</b>        |  | <b>Fax</b>         |  |
| <b>Email</b>        |  |                    |  |

**Note:** If this product or assembly has been quoted or ordered before, please provide the quote number or order number.

|                  |  |                  |  |
|------------------|--|------------------|--|
| <b>Quote No.</b> |  | <b>Order No.</b> |  |
|------------------|--|------------------|--|

### 2. Screw and Nut Part Numbers

|                     |  |                        |                                       |                                       |                                       |                                       |                                       |
|---------------------|--|------------------------|---------------------------------------|---------------------------------------|---------------------------------------|---------------------------------------|---------------------------------------|
| <b>Qty.</b>         |  | <b>Lead Error</b>      | 0.004"/ft<br><input type="checkbox"/> | 0.005"/ft<br><input type="checkbox"/> | 50µ/300mm<br><input type="checkbox"/> | 23µ/300mm<br><input type="checkbox"/> | 12µ/300mm<br><input type="checkbox"/> |
| <b>Diameter</b>     |  | <b>Lead</b>            |                                       |                                       |                                       |                                       |                                       |
| <b>Screw P/N</b>    |  | <b>Overall Length*</b> |                                       |                                       |                                       |                                       |                                       |
| <b>Ball Nut P/N</b> |  | <b>Flange P/N</b>      |                                       | <b>Wiper P/N</b>                      |                                       |                                       |                                       |

### 3. Bearing Supports

|                  |                               |                                   |                                      |
|------------------|-------------------------------|-----------------------------------|--------------------------------------|
| <b>Right End</b> | <input type="checkbox"/> None | <input type="checkbox"/> Floating | <input type="checkbox"/> Quick Mount |
| <b>Left End</b>  | <input type="checkbox"/> None | <input type="checkbox"/> Floating | <input type="checkbox"/> Quick Mount |

### 4. End Machining\*

|                  |                              |                              |                              |                              |                              |                              |   |
|------------------|------------------------------|------------------------------|------------------------------|------------------------------|------------------------------|------------------------------|---|
| <b>Right End</b> | <input type="checkbox"/> BK  | <input type="checkbox"/> BF  | <input type="checkbox"/> FK  | <input type="checkbox"/> FF  | <input type="checkbox"/> QK  | <input type="checkbox"/> QF  | <input type="checkbox"/> Cut to Length Only                       |
|                  | <input type="checkbox"/> BK1 | <input type="checkbox"/> BF1 | <input type="checkbox"/> FK1 | <input type="checkbox"/> FF1 | <input type="checkbox"/> QK1 | <input type="checkbox"/> QF1 | <input type="checkbox"/> Annealed _____ (specify length annealed) |
| <b>Left End</b>  | <input type="checkbox"/> BK  | <input type="checkbox"/> BF  | <input type="checkbox"/> FK  | <input type="checkbox"/> FF  | <input type="checkbox"/> QK  | <input type="checkbox"/> QF  | <input type="checkbox"/> Cut to Length Only                       |
|                  | <input type="checkbox"/> BK1 | <input type="checkbox"/> BF1 | <input type="checkbox"/> FK1 | <input type="checkbox"/> FF1 | <input type="checkbox"/> QK1 | <input type="checkbox"/> QF1 | <input type="checkbox"/> Annealed _____ (specify length annealed) |

### 5. Configuration\*

|   |  |   |
|---|--|---|
| <input type="checkbox"/> Ball Nut (V-Thread/Flange) Facing Left End | <input type="checkbox"/> Ball Nut (V-Thread/Flange) Facing Right End | <input type="checkbox"/> Modified Flange (Attach Print) |
|---|--|---|

\* Customer print will take precedence if provided.

Need a quote or have a question about an application?  
Contact us in North America at:

Phone: 540-633-3549

Fax: 540-639-4162

Email: thomson@thomsonlinear.com

Date: \_\_\_\_/\_\_\_\_/\_\_\_\_

## Application Data Sheet

Use this form if you need assistance selecting a product. We will respond within four hours.

### 1. Information

|                     |  |                    |  |
|---------------------|--|--------------------|--|
| <b>Name</b>         |  | <b>Title/Dept.</b> |  |
| <b>Company Name</b> |  |                    |  |
| <b>Address</b>      |  |                    |  |
| <b>Phone</b>        |  | <b>Fax</b>         |  |
| <b>Email</b>        |  |                    |  |

### 2. Application Requirements

|                           |  |                              |   |
|---------------------------|--|------------------------------|---|
| <b>What is your LOAD?</b> |  | <input type="checkbox"/> lbs | <input type="checkbox"/> kg                     |
|                           |  | <input type="checkbox"/> N   | <input type="checkbox"/> Other (please specify) |

|                             |  |   |                                     |
|-----------------------------|--|---|-------------------------------------|
| <b>What is your MOTION?</b> |  | <input type="checkbox"/> Vertical               | <input type="checkbox"/> Horizontal |
|                             |  | <input type="checkbox"/> Other (please specify) |                                     |

|                                       |  |                               |   |
|---------------------------------------|--|-------------------------------|---|
| <b>What is your length of STROKE?</b> |  | <input type="checkbox"/> inch | <input type="checkbox"/> foot                   |
|                                       |  | <input type="checkbox"/> mm   | <input type="checkbox"/> Other (please specify) |

|   |  |                               |   |
|---|--|-------------------------------|---|
| <b>What is your required TRAVEL LIFE?</b> |  | <input type="checkbox"/> inch | <input type="checkbox"/> foot                   |
|   |  | <input type="checkbox"/> mm   | <input type="checkbox"/> Other (please specify) |

|                            |  |                               |     |   |
|----------------------------|--|-------------------------------|-----|---|
| <b>What is your SPEED?</b> |  | <input type="checkbox"/> inch | PER | <input type="checkbox"/> minute                 |
|                            |  | <input type="checkbox"/> mm   |     | <input type="checkbox"/> second                 |
|                            |  | <input type="checkbox"/> foot |     | <input type="checkbox"/> Other (please specify) |

|                              |                                       |                                       |   |   |   |                        |
|------------------------------|---------------------------------------|---------------------------------------|---|---|---|------------------------|
| <b>Accuracy Requirements</b> | 0.004"/ft<br><input type="checkbox"/> | 0.005"/ft<br><input type="checkbox"/> | 52 $\mu$ /300mm<br><input type="checkbox"/> | 23 $\mu$ /300mm<br><input type="checkbox"/> | 12 $\mu$ /300mm<br><input type="checkbox"/> | Other (please specify) |
|------------------------------|---------------------------------------|---------------------------------------|---|---|---|------------------------|

|                              |                                    |                                    |                                    |                                    |                                   |                        |
|------------------------------|------------------------------------|------------------------------------|------------------------------------|------------------------------------|-----------------------------------|------------------------|
| <b>Backlash Requirements</b> | 0.000"<br><input type="checkbox"/> | 0.002"<br><input type="checkbox"/> | 0.010"<br><input type="checkbox"/> | 0.05mm<br><input type="checkbox"/> | 0.2mm<br><input type="checkbox"/> | Other (please specify) |
|------------------------------|------------------------------------|------------------------------------|------------------------------------|------------------------------------|-----------------------------------|------------------------|

|                          |   |                                     |                                       |
|--------------------------|---|-------------------------------------|---------------------------------------|
| <b>Bearing Supports?</b> | <input type="checkbox"/> Fixed/Fixed            | <input type="checkbox"/> Fixed/Free | <input type="checkbox"/> Fixed/Simple |
|                          | <input type="checkbox"/> Other (please specify) |                                     |                                       |

|                             |                                  |                                  |   |
|-----------------------------|----------------------------------|----------------------------------|---|
| <b>Motor Cube Required?</b> | <input type="checkbox"/> NEMA 17 | <input type="checkbox"/> NEMA 23 | <input type="checkbox"/> Other (please specify) |
|                             | <input type="checkbox"/> NEMA 42 | <input type="checkbox"/> NEMA 34 |   |

|                           |  |                                   |   |
|---------------------------|--|-----------------------------------|---|
| <b>Quantity Required?</b> |  | <input type="checkbox"/> per Week | <input type="checkbox"/> per Month              |
|                           |  | <input type="checkbox"/> per Year | <input type="checkbox"/> Other (please specify) |

|  |  |
|--|--|
| <b>Additional Information/Comments</b> |  |
|--|--|

## Technology Comparison

### Thomson Ball Screws and Lead Screws Are Your Best Choice for Linear Actuation

Thomson ball screws outperform other actuation methods.

Compared to bulky, noisy, and expensive hydraulic or pneumatic actuator systems, Thomson ball screws and lead screws are compact, quiet, and very affordable. In addition, there's no need for pumps, hoses, fluids, or shop air. This eliminates fire, safety, and health hazards due to leaking fluid or other contaminants typically associated with these types of actuation methods.

Belt, cable, and chain-drive mechanisms are relatively inexpensive. However, they aren't as precise, repeatable, or as safe to use as ball screws and lead screws. Their failure mode is either excessive wear or stretching, resulting in positioning inaccuracies during operation. These types of systems also have low load capacities.

Rack and pinion gear systems can be made to close tolerances, but lose precision as they wear and don't function as smoothly as ball screws, even when new. Because the force is supported by a few pinion teeth at any given time, the system also is limited in terms of load capacity.

Offset cam rollers rely on the tractive force between the rollers and the shaft to create linear motion, and therefore can handle only

moderate loads. The higher the load, the more likely it is that the system will slip, reducing repeatability.

In summary, when compared to other types of mechanical actuation methods, Thomson ball screws and lead screws provide the most cost-effective combination of speed, accuracy, efficiency, repeatability, quiet operation, lubrication retention, load capacity, and compactness.

Thomson precision ball screw and lead screw assemblies are the first choice in precise, reliable, cost-effective linear actuation.

Thomson lead screws excel in applications which require the "just right" solution. They are easily customized to provide compact, quiet and accurate positioning in light to medium load applications. Materials are inert as a standard and allow use in applications ranging from clean room to marine. Best of all, the value is high as you don't pay for processes and features not required in your application.

Let Thomson engineer your positioning screw today.

### Ball and Lead Screw vs. Other Actuation Methods

|                         | Thomson Lead Screws | Thomson Ball Screws | Fluid Power | Belt, Cable, and Chain-Drive Mechanisms | Rack & Pinion | Offset Cam Rollers | Pneumatic Cylinders |
|-------------------------|---------------------|---------------------|-------------|---|---------------|--------------------|---------------------|
| Inexpensive             | ●                   | ●                   | ○           | ●                                       |               | ●                  |                     |
| Low Power Consumption   |                     | ●                   |             | ●                                       | ●             | ●                  |                     |
| Low Maintenance         | ●                   | ●                   |             | ○                                       | ○             | ○                  | ●                   |
| High Accuracy           |                     | ●                   |             |   |               |                    |                     |
| High Repeatability      | ○                   | ●                   |             |   |               |                    |                     |
| High Efficiency         |                     | ●                   |             |   | ○             | ○                  |                     |
| High Load Capacity      |                     | ●                   | ●           |   |               |                    | ○                   |
| Compact Size            | ●                   | ●                   |             |   | ●             |                    | ○                   |
| Speed                   | ●                   | ●                   |             | ●                                       | ●             |                    | ●                   |
| Low Noise               | ●                   | ○                   |             | ○                                       |               | ○                  |                     |
| Design Flexibility      | ●                   | ●                   |             |   | ○             |                    |                     |
| Contamination Tolerance | ●                   | ○                   | ●           |   |               |                    |                     |

● = always  
○ = in most cases



## Technology Comparison

### Design Considerations for Choosing Screw Type

| Design Considerations | Thomson Lead Screw   | Thomson Ball Screw   |
|-----------------------|--|--|
| Load                  | Typically light (<100 lbs.)                                      | Usually heavy (>100 lbs.)  |
| Cost                  | Low cost \$\$  | Higher cost \$\$\$   |
| Anti-backlash         | Available — but has low stiffness                                | Available  |
| Self-locking          | Yes — but depends on lead and lubrication                        | Fail safe brake locking option   |
| Efficiency            | Generally ranges from 30% to 70%                                 | Generally ranges from 85% to 95%   |
| Duty Cycle            | Limited to plastic heat transfer properties                      | Unlimited  |
| Corrosion Resistance  | Available in stainless steel as a standard                       | Wide range of available sizes in stainless steel, as well as coating and plating options |
| Lubrication           | Can operate with or without lubrication depending on application | Must have lubrication<br>Wide range of lubricants  |
| Operating Temperature | Limited to expansion differences between the screw and the nut   | Wide temperature range   |
| Travel Speed          | Available in wide range of leads                                 | Typically mid-range leads  |
| Vibration and Noise   | Typically quiet,<br>high leads are best                          | Ball re-circulation  |
| Custom Availability   | Great flexibility in customizing materials and geometry          | Great flexibility in customizing materials and geometry — limited by ball path envelope  |
| Catalog Page          | 11   | 40   |



**NOTES:**

A large rectangular area filled with a light gray grid pattern, intended for taking notes. The grid consists of small squares and covers most of the page's vertical space.

# Lead Screws



## Table of Contents

| <b>Description</b>                     | <b>Page</b> |
|--|-------------|
| Product Overview .....                 | 12          |
| Glide Screws .....                     | 14          |
| Advanced Anti-Backlash Supernuts ..... | 15          |
| Flange Mount Supernuts .....           | 26          |
| Thread Mount Supernuts .....           | 29          |
| Thread Mount Bronze Nuts .....         | 33          |
| Standard Mounting Flanges .....        | 35          |
| Stainless Steel Lead Screws .....      | 36          |
| V-Thread Screws .....                  | 39          |

Need a quote or have a question about an application?  
Contact us in North America at:

Phone: 800-882-8857

Email: [thomsonbsa@thomsonlinear.com](mailto:thomsonbsa@thomsonlinear.com)

Web: [www.thomsonbsa.com](http://www.thomsonbsa.com)

## Lead Screws Product Overview

Offering smooth, precise, cost effective positioning, this is the “just right” solution for your application.

Thomson BSA precision lead screws are an excellent economical solution for your linear motion requirements. For more than 25 years, Thomson BSA has designed and manufactured the highest quality lead screw assemblies in the industry. Our precision rolling machines ensure accurate positioning to 0.003 in/ft and our PTFE coating process produces assemblies that have less drag torque and last longer.

Thomson BSA provides a large array of standard plastic nut assemblies in anti-backlash or standard Supernut® designs. All of our standard plastic nut assemblies use an internally lubricated Acetal — providing excellent lubricity and wear resistance with or without additional lubrication. With the introduction of our new unique patent pending zero backlash designs, Thomson BSA provides assemblies with high axial stiffness, zero backlash and the absolute minimum drag torque to reduce motor requirements. These designs produce products that cost less, perform better and last longer. Both designs automatically adjust for wear, insuring zero backlash for the life of the nut.

For significantly higher loads, standard bronze nuts are available. Thomson BSA uses SAE 660 bearing bronze, which provides high load capacity with good PV performance. We also offer end machining to your specification or can provide you with stock bearing mounts or motor mounts. Available from over 1800 distributors worldwide.

Thomson BSA also provides engineering design services to aid in your design requirements, producing a lead screw assembly to your specifications. Call the factory today to discuss your application with one of our experienced application engineers, 800-882-8857.

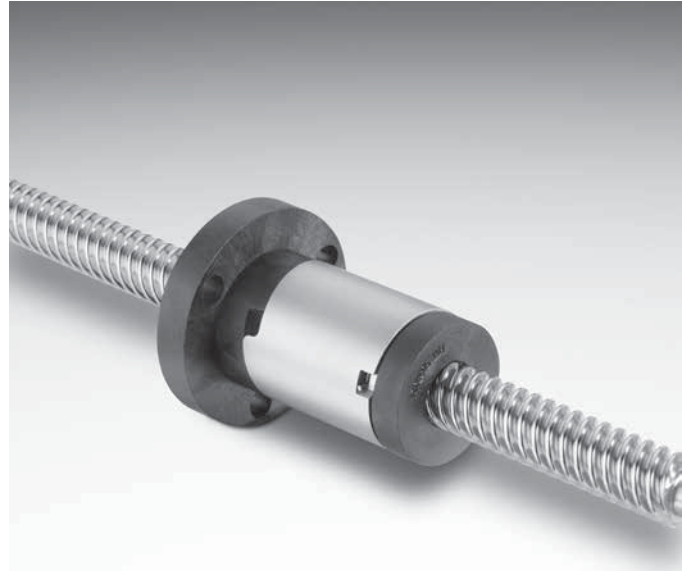

## Glide Screw Overview

What is a Glide Screw™? Part linear bearing, part lead screw; a combination of two favorites to create something better than both. The patent-pending Glide Screw™ brings high performance, fast installation and less complexity in a small package. The Glide Screw™ combines the features of a linear bearing and a lead screw in one smooth operating package. Inch and metric sizes are standard. Custom sizes are also available quickly and to your specification.

### Standard Sizes and Configurations Stocked for Immediate Availability!

- Metric Series includes 4, 6 and 10 mm nominal diameters
- Inch Series includes 3/16", 1/4" and 3/8" nominal diameters
- Flanged and cylindrical nut bodies standard

### Optional Configurations for Harsh Environments Available

- High temperature resistant – inside ovens or autoclaves (up to 175 °C)
- Clean room – in robot vacuum chambers, laboratories or medical equipment (ISO 6)
- Food grade – in packaging and food processing equipment

### Custom Nut Configurations, Screw Diameters and Thread Leads Available

- Don't see your perfect configuration – call us, we make custom sizes!

### Easy to Install and Maintenance Free!

- All that is required is a Glide Screw™ and an anti-rotation feature
- No need for reference surfaces or the pain of “floating” your system into alignment
- Plug and play! Install it and forget it!
- Integrated Thomson's patented Lube for Life technology
- Bearing grade plastic and stainless steel construction standard

### Reduced Footprint

- Integrated lead screw / linear bearing
- Side load / moment load capable

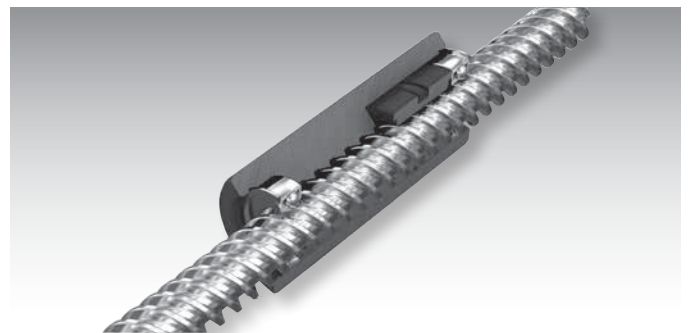

### Improved Equipment Uptime

- Screw and linear bearing are already aligned
- Component alignment is not critical – smooth and quiet motion
- Integrated lubrication block – Thomson Lube for Life standard

### Lower Cost of Ownership

- Less complexity – faster installation
- Less components – simpler bill of material
- Maintenance free! No lubrication required

## Lead Screws Product Overview

### Lead Screw Product Summary

| Series           | Thomson BSA Precision Lead Screw                  |  |
|------------------|---|--|
|                  | Inch  | Metric   |
| Lead accuracy    | .010"/ft. for standard<br>.003"/ft. for precision | 250 micron/300mm for standard<br>75 micron/300mm for precision |
| Diameter         | .187" - 3.00"                                     | 6mm - 24mm   |
| Lead             | .013" - 2.00"                                     | .5mm - 50.0mm  |
| Backlash         | .010" (max)                                       | .25mm (max)  |
| Dynamic Load     | Up to 400 lbs*                                    | Up to 1.3 kN*  |
| Max. Static Load | Up to 2,000 lbs*                                  | Up to 6.6 kN*  |
| Catalog Pages    | 15 - 39   | 15 - 39  |

\* Plastic nut ratings. Does not include bronze nut specifications.

### Lead Screw Product Availability

|            | Inch  | Lead (in.) |       |       |       |       |       |       |       |       |       |       |       |       |       |       |       |       |       |       |
|------------|-------|------------|-------|-------|-------|-------|-------|-------|-------|-------|-------|-------|-------|-------|-------|-------|-------|-------|-------|-------|
|            |       | 0.031      | 0.050 | 0.063 | 0.083 | 0.100 | 0.125 | 0.167 | 0.200 | 0.250 | 0.300 | 0.375 | 0.400 | 0.500 | 0.750 | 0.800 | 1.000 | 1.200 | 1.500 | 2.000 |
| Dia. (in.) | 3/16  |            | ●     |       |       | ●     | ●     |       | ●     |       |       | ●     | ●     | ●     |       |       |       |       |       |       |
|            | 1/4   | ●          | ●     | ●     |       |       | ●     |       | ●     | ●     |       |       |       | ●     | ●     |       |       |       |       |       |
|            | 5/16  |            |       |       | ●     |       |       | ●     |       | ●     |       |       |       | ●     |       |       | ●     |       |       |       |
|            | 3/8   |            | ●     | ●     | ●     | ●     | ●     | ●     | ●     | ●     | ●     |       |       | ●     | ●     |       | ●     | ●     |       |       |
|            | 7/16  |            |       |       |       |       | ●     |       |       | ●     |       |       |       | ●     |       |       |       |       |       |       |
|            | 1/2   |            |       | ●     |       | ●     |       |       | ●     | ●     |       |       |       | ●     |       | ●     | ●     |       | ●     |       |
|            | 5/8   |            |       |       |       | ●     | ●     |       | ●     | ●     |       |       |       | ●     |       |       |       |       |       |       |
|            | 3/4   |            |       |       |       | ●     | ●     | ●     | ●     |       |       |       |       | ●     |       |       | ●     |       | ●     | ●     |
|            | 1     |            |       |       |       | ●     | ●     |       | ●     | ●     |       |       |       | ●     |       |       | ●     |       |       |       |
|            | 1-1/4 |            |       |       |       |       |       |       | ●     | ●     |       |       |       |       |       |       |       |       |       |       |
|            | 1-1/2 |            |       |       |       |       |       |       | ●     | ●     |       | ●     |       | ●     |       |       |       |       |       |       |
|            | 2     |            |       |       |       |       |       |       |       | ●     |       |       |       |       |       |       |       |       |       |       |
|            | 2-1/4 |            |       |       |       |       |       |       |       | ●     |       |       |       |       |       |       |       |       |       |       |
|            | 2-1/2 |            |       |       |       |       |       |       |       | ●     |       |       |       |       |       |       |       |       |       |       |
|            | 2-3/4 |            |       |       |       |       |       |       |       | ●     |       |       |       |       |       |       |       |       |       |       |
| 3          |       |            |       |       |       |       |       |       | ●     |       |       |       |       |       |       |       |       |       |       |       |

|           | Metric | Lead (mm) |   |   |   |   |   |   |    |    |    |    |    |    |    |    |    |
|-----------|--------|-----------|---|---|---|---|---|---|----|----|----|----|----|----|----|----|----|
|           |        | 1         | 2 | 3 | 4 | 5 | 6 | 8 | 10 | 12 | 15 | 16 | 20 | 25 | 35 | 45 | 50 |
| Dia. (mm) | 4      | ●         |   |   | ● |   |   | ● |    |    |    |    |    |    |    |    |    |
|           | 6      | ●         | ● | ● |   |   | ● |   | ●  |    |    |    |    |    |    |    |    |
|           | 10     |           | ● | ● | ● | ● | ● |   | ●  | ●  |    |    | ●  |    |    |    |    |
|           | 12     |           |   | ● | ● | ● | ● |   | ●  |    | ●  |    |    | ●  |    | ●  |    |
|           | 16     |           |   |   | ● | ● |   | ● |    |    |    | ●  |    | ●  | ●  |    |    |
|           | 20     |           |   |   | ● |   |   | ● |    | ●  |    | ●  | ●  |    |    | ●  | ●  |
|           | 24     |           |   |   |   | ● |   |   |    |    |    |    |    |    |    |    |    |

Availability charts do not include V-thread screw leads.

## Glide Screw™ configurations

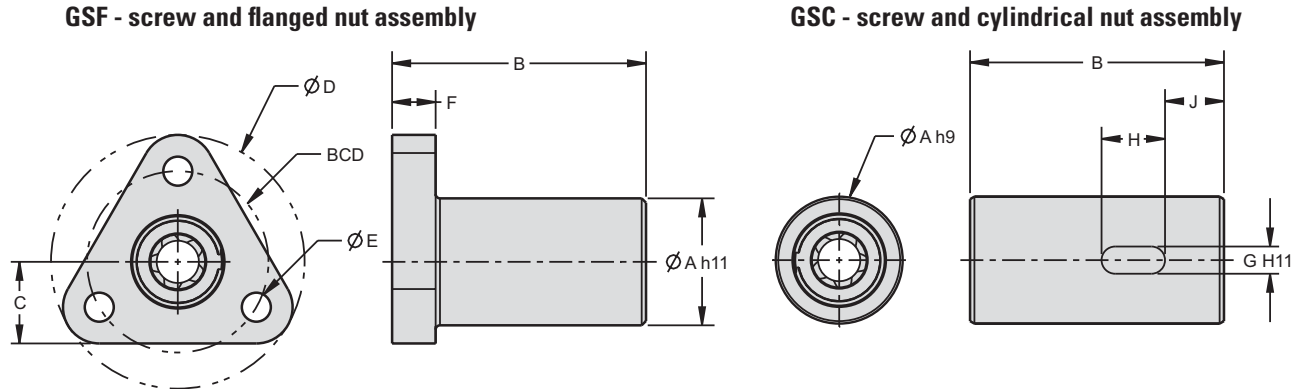

Part number example: GSC25x0500 = glide screw assembly, cylindrical nut, 0.250 inch diameter by 0.500 inch lead

### Inch Series Dimensions

| Screw Diam. [in] | Screw Lead [in] | Screw and Nut Assembly Part No. | Max Axial Load [lbs] | Max Moment Load [in-lbs] | Max Screw Length [in] | Dimensions [in] |       |       |       |       |       |       |       |       |       | Effic. [%] |
|------------------|-----------------|---------------------------------|----------------------|--------------------------|-----------------------|-----------------|-------|-------|-------|-------|-------|-------|-------|-------|-------|------------|
|                  |                 |                                 |                      |                          |                       | A               | B     | C     | D     | E     | F     | G     | H     | J     | BCD   |            |
| 0.188            | 0.050           | GS_18x0050                      | 30.0                 | 20.5                     | 6.000                 | 0.375           | 0.750 | 0.281 | 0.875 | 0.140 | 0.125 | 0.094 | 0.188 | 0.177 | 0.625 | 46         |
|                  | 0.125           | GS_18x0125                      |                      |                          |                       |                 |       |       |       |       |       |       |       |       |       | 68         |
| 0.250            | 0.050           | GS_25x0050                      | 45.0                 | 47.5                     | 10.000                | 0.500           | 1.000 | 0.313 | 1.000 | 0.140 | 0.150 | 0.125 | 0.250 | 0.237 | 0.750 | 40         |
|                  | 0.500           | GS_25x0500                      |                      |                          |                       |                 |       |       |       |       |       |       |       |       |       | 82         |
| 0.375            | 0.063           | GS_37x0063                      | 70.0                 | 137.5                    | 18.000                | 0.875           | 1.750 | 0.563 | 1.500 | 0.200 | 0.300 | 0.188 | 0.438 | 0.406 | 1.188 | 36         |
|                  | 0.500           | GS_37x0500                      |                      |                          |                       |                 |       |       |       |       |       |       |       |       |       | 78         |
|                  | 1.000           | GS_37x1000                      |                      |                          |                       |                 |       |       |       |       |       |       |       |       |       | 83         |

### Metric Series Dimensions

| Screw Diam. [mm] | Screw Lead [mm] | Screw and Nut Assembly Part No. | Max Axial Load [N] | Max Moment Load [Nm] | Max Screw Length [mm] | Dimensions [mm] |    |      |    |     |   |   |    |      |     | Effic. [%] |
|------------------|-----------------|---------------------------------|--------------------|----------------------|-----------------------|-----------------|----|------|----|-----|---|---|----|------|-----|------------|
|                  |                 |                                 |                    |                      |                       | A               | B  | C    | D  | E   | F | G | H  | J    | BCD |            |
| 4                | 1               | GS_4x1M                         | 89.0               | 2.3                  | 150                   | 10              | 20 | 6.5  | 20 | 2.5 | 3 | 2 | 5  | 5    | 15  | 45         |
|                  | 4               | GS_4x4M                         |                    |                      |                       |                 |    |      |    |     |   |   |    |      |     | 75         |
|                  | 8               | GS_4x8M                         |                    |                      |                       |                 |    |      |    |     |   |   |    |      |     | 82         |
| 6                | 1               | GS_6x1M                         | 133.4              | 5.4                  | 250                   | 13              | 26 | 7.75 | 25 | 3.5 | 4 | 3 | 7  | 5.75 | 19  | 36         |
|                  | 6               | GS_6x6M                         |                    |                      |                       |                 |    |      |    |     |   |   |    |      |     | 75         |
|                  | 12              | GS_6x12M                        |                    |                      |                       |                 |    |      |    |     |   |   |    |      |     | 82         |
| 10               | 2               | GS_10x2M                        | 311.4              | 15.5                 | 450                   | 22              | 44 | 12   | 38 | 5   | 7 | 4 | 10 | 9.85 | 30  | 40         |
|                  | 6               | GS_10x6M                        |                    |                      |                       |                 |    |      |    |     |   |   |    |      |     | 66         |
|                  | 12              | GS_10x12M                       |                    |                      |                       |                 |    |      |    |     |   |   |    |      |     | 77         |

#### Standard Products

- Acetal nut body with all stainless steel internal components
- 303 stainless steel screw
- Integrated Lube for Life lubrication block
- Temperature Rating: -40° to 65°C (-40° to 150°F)
- Clean Room ISO 7 (Class 10000)

#### High Temperature

- PEEK nut material and high temperature internal components
- Temperature Rating: -10 to 175 °C (15 to 350 °F)

#### Clean Room/Vacuum Grade

- Class ISO 6 (Class 1000)
- Vacuum rating of <math>10^{-6}</math> Torr
- PEEK nut material with appropriate grade components
- Alternative lubrication system

#### Food Grade Configuration

- Food grade lubricants
- Rulon nut body, USDA-H1 compatible

## Advanced Anti-Backlash Supernuts®

### XCM 1800

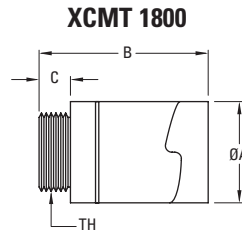

Our smallest anti-backlash nut design ever. The XCM 1800 uses the same patented† ActiveCAM™ mechanism as its larger siblings in a miniaturized package. This allows backlash free operation in space critical applications requiring high accuracy and low drag torque. This cost effective solution is available in either flanged or threaded versions. TriCoat® PTFE dry film lubricant is available as an option on most screws.

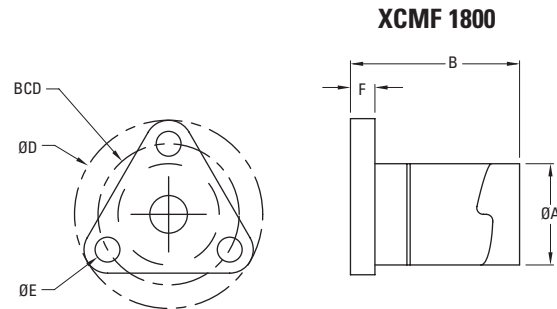

Note: See Screw Section on page 36. Specify XCMT or XCMF when ordering, see drawings at right.

| Dia.  | Lead   | Part No.    | Supernut® Dimensions |            |       |      |       |      |       |          | Design Load | Efficiency % | Drag Torque oz-in |
|-------|--------|-------------|----------------------|------------|-------|------|-------|------|-------|----------|-------------|--------------|-------------------|
|       |        |             | A                    | B          | C     | D    | E     | F    | BCD   | TH       |             |              |                   |
| 3/16" | 0.050  | XCM_1820    | 0.50                 | 0.90 (max) | 0.200 | 1.00 | 0.143 | 0.18 | 0.750 | 7/16"-20 | 5 lbs       | 49           | < 1               |
|       | 0.100  | XCM_2-1820  |                      |            |       |      |       |      |       |          |             | 66           |                   |
|       | 0.125  | XCM_3-1824  |                      |            |       |      |       |      |       |          |             | 70           |                   |
|       | 0.200  | XCM_4-1820  |                      |            |       |      |       |      |       |          |             | 77           |                   |
|       | 0.375  | XCM_8-1821  |                      |            |       |      |       |      |       |          |             | 81           |                   |
|       | 0.400  | XCM_8-1820  |                      |            |       |      |       |      |       |          |             | 82           |                   |
|       | 0.500  | XCM_10-1820 |                      |            |       |      |       |      |       |          |             | 82           |                   |
| 6mm*  | 1mm    | XCM_6x1     | 0.50                 | 0.90 (max) | 0.200 | 1.00 | 0.143 | 0.18 | 0.750 | 7/16"-20 | 5 lbs       | 29           | < 1               |
| 1/4"  | 0.0125 | XCM_2580    | 0.50                 | 0.90 (max) | 0.200 | 1.00 | 0.143 | 0.18 | 0.750 | 7/16"-20 | 5 lbs       | 13           | < 1               |
|       | 0.0208 | XCM_2548    |                      |            |       |      |       |      |       |          |             | 20           |                   |
|       | 0.0250 | XCM_2540    |                      |            |       |      |       |      |       |          |             | 23           |                   |
|       | 0.0278 | XCM_2536    |                      |            |       |      |       |      |       |          |             | 25           |                   |
|       | 0.0313 | XCM_2532    |                      |            |       |      |       |      |       |          |             | 28           |                   |
|       | 0.0357 | XCM_2528    |                      |            |       |      |       |      |       |          |             | 30           |                   |
|       | 0.0417 | XCM_2524    |                      |            |       |      |       |      |       |          |             | 34           |                   |
| 1/4"  | 0.050  | XCM_2520    | 0.50                 | 0.90 (max) | 0.200 | 1.00 | 0.143 | 0.18 | 0.750 | 7/16"-20 | 5 lbs       | 41           | < 1               |
|       | 0.063  | XCM_2516    |                      |            |       |      |       |      |       |          |             | 48           |                   |
|       | 2mm    | XCM_2-25x1M |                      |            |       |      |       |      |       |          |             | 53           |                   |
|       | 3mm    | XCM_3-25x1M |                      |            |       |      |       |      |       |          |             | 62           |                   |
|       | 0.125  | XCM_2-2516  |                      |            |       |      |       |      |       |          |             | 64           |                   |
|       | 0.200  | XCM_4-2520  |                      |            |       |      |       |      |       |          |             | 72           |                   |
|       | 0.250  | XCM_4-2516  |                      |            |       |      |       |      |       |          |             | 76           |                   |
|       | 0.500  | XCM_7-2514  |                      |            |       |      |       |      |       |          |             | 81           |                   |
|       | 0.750  | XCM_12-2516 |                      |            |       |      |       |      |       |          |             | 82           |                   |

\* V-Thread screws, see page 39.

† Patent No. 5839321

## Advanced Anti-Backlash Supernuts®

### XC 2500



The XC Model Anti-Backlash assembly is the most advanced Anti-Backlash nut design. The unique patented† ActiveCAM™ accomplishes high axial stiffness, zero backlash and the absolute minimum drag torque. This advantage produces assemblies that cost less, perform better and last longer. The ActiveCAM™ automatically adjusts for wear insuring zero backlash for the life of the nut.

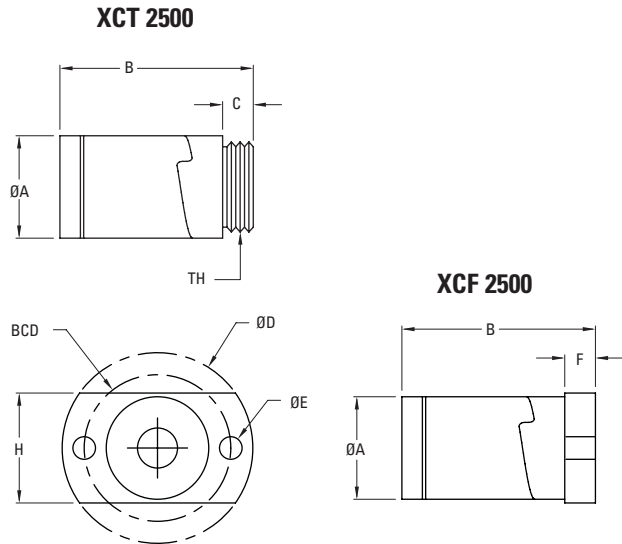

Note: See Screw Section on page 36. Specify XCT or XCF when ordering, see drawings at right.

| Dia.  | Lead   | Part No.   | Supernut® Dimensions |            |       |      |       |      |      |       |           | Design Load | Efficiency % | Drag Torque oz-in |
|-------|--------|------------|----------------------|------------|-------|------|-------|------|------|-------|-----------|-------------|--------------|-------------------|
|       |        |            | A                    | B          | C     | D    | E     | F    | H    | BCD   | TH        |             |              |                   |
| 6mm*  | 1mm    | XC_6x1     | 0.64                 | 1.18 (max) | 0.187 | 1.19 | 0.141 | 0.16 | 0.66 | 0.900 | 9/16" -18 | 10lbs       | 29           | <1                |
| 1/4"* | 0.0125 | XC_2580    | 0.64                 | 1.18 (max) | 0.187 | 1.19 | 0.141 | 0.16 | 0.66 | 0.900 | 9/16" -18 | 10lbs       | 13           | <1                |
|       | 0.0208 | XC_2548    |                      |            |       |      |       |      |      |       |           |             | 20           |                   |
|       | 0.0250 | XC_2540    |                      |            |       |      |       |      |      |       |           |             | 23           |                   |
|       | 0.0278 | XC_2536    |                      |            |       |      |       |      |      |       |           |             | 25           |                   |
|       | 0.0313 | XC_2532    |                      |            |       |      |       |      |      |       |           |             | 28           |                   |
|       | 0.0357 | XC_2528    |                      |            |       |      |       |      |      |       |           |             | 30           |                   |
|       | 0.0417 | XC_2524    |                      |            |       |      |       |      |      |       |           |             | 34           |                   |
| 1/4"  | 0.050  | XC_2520    | 0.64                 | 1.18 (max) | 0.187 | 1.19 | 0.141 | 0.16 | 0.66 | 0.900 | 9/16" -18 | 10lbs       | 41           | <1                |
|       | 0.063  | XC_2516    |                      |            |       |      |       |      |      |       |           |             | 48           |                   |
|       | 2mm    | XC_2-25x1M |                      |            |       |      |       |      |      |       |           |             | 53           |                   |
|       | 3mm    | XC_3-25x1M |                      |            |       |      |       |      |      |       |           |             | 62           |                   |
|       | 0.125  | XC_2-2516  |                      |            |       |      |       |      |      |       |           |             | 64           |                   |
|       | 0.200  | XC_4-2520  |                      |            |       |      |       |      |      |       |           |             | 72           |                   |
|       | 0.250  | XC_4-2516  |                      |            |       |      |       |      |      |       |           |             | 76           |                   |
|       | 0.500  | XC_7-2514  |                      |            |       |      |       |      |      |       |           |             | 81           |                   |
|       | 0.750  | XC_12-2516 |                      |            |       |      |       |      |      |       |           |             | 82           |                   |

\* V-Thread screws, see page 39.

† Patent No. 5839321



## Advanced Anti-Backlash Supernuts®

### XC 3700

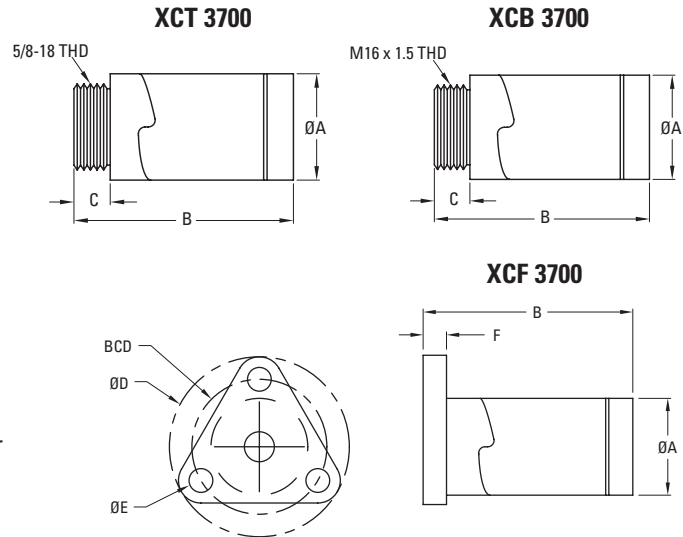

The XC Model Anti-Backlash assembly is the most advanced Anti-Backlash nut design. The unique patented† ActiveCAM™ accomplishes high axial stiffness, zero backlash and the absolute minimum drag torque. This advantage produces assemblies that cost less, perform better and last longer. The ActiveCAM™ automatically adjusts for wear insuring zero backlash for the life of the nut.

Note: See Screw Section on page 36. Specify XCT, XCB or XCF when ordering, see drawings at right.

| Dia.  | Lead         | Part No.     | Supernut® Dimensions |             |      |     |     |     |       | Design Load | Efficiency % | Drag Torque oz-in |
|-------|--------------|--------------|----------------------|-------------|------|-----|-----|-----|-------|-------------|--------------|-------------------|
|       |              |              | A                    | B           | C    | D   | E   | F   | BCD   |             |              |                   |
| 5/16" | 0.083        | XC_3112      | 0.82                 | 1.875 (max) | 0.25 | 1.5 | 0.2 | 0.2 | 1.125 | 25 lbs      | 49           | 1 - 3             |
|       | 0.167        | XC_2-3112    |                      |             |      |     |     |     |       |             | 65           |                   |
|       | 0.250        | XC_2-3108    |                      |             |      |     |     |     |       |             | 72           |                   |
|       | 0.500        | XC_4-3108    |                      |             |      |     |     |     |       |             | 80           |                   |
|       | 1.000        | XC_8-3108    |                      |             |      |     |     |     |       |             | 81           |                   |
| 3/8"  | 0.050        | XC_3720      | 0.82                 | 1.875 (max) | 0.25 | 1.5 | 0.2 | 0.2 | 1.125 | 25 lbs      | 32           | 1 - 3             |
|       | 0.063        | XC_3716      |                      |             |      |     |     |     |       |             | 36           |                   |
|       | 2mm          | XC_37x2M     |                      |             |      |     |     |     |       |             | 42           |                   |
|       | 0.083        | XC_3712      |                      |             |      |     |     |     |       |             | 44           |                   |
|       | 0.100        | XC_3710      |                      |             |      |     |     |     |       |             | 49           |                   |
|       | 0.125        | XC_3708      |                      |             |      |     |     |     |       |             | 53           |                   |
|       | 0.167        | XC_2-3712    |                      |             |      |     |     |     |       |             | 60           |                   |
|       | 0.200        | XC_2-3710    |                      |             |      |     |     |     |       |             | 65           |                   |
|       | 0.250        | XC_2-3708    |                      |             |      |     |     |     |       |             | 68           |                   |
|       | 0.300        | XC_3-3710    |                      |             |      |     |     |     |       |             | 73           |                   |
|       | 0.375        | XC_4-3711    |                      |             |      |     |     |     |       |             | 75           |                   |
|       | 0.500        | XC_4-3708    |                      |             |      |     |     |     |       |             | 79           |                   |
| 0.750 | XC_6-3708    | 82           |                      |             |      |     |     |     |       |             |              |                   |
| 10mm  | 2mm          | XC_10x2M     | 0.82                 | 1.875 (max) | 0.25 | 1.5 | 0.2 | 0.2 | 1.125 | 25 lbs      | 41           | 1 - 3             |
|       | 3mm          | XC_10x3M     |                      |             |      |     |     |     |       |             | 53           |                   |
|       | 4mm          | XC_2-10x2M   |                      |             |      |     |     |     |       |             | 59           |                   |
|       | 5mm          | XC_2-10x2.5M |                      |             |      |     |     |     |       |             | 64           |                   |
|       | 6mm          | XC_4-10x1.5M |                      |             |      |     |     |     |       |             | 67           |                   |
|       | 10mm         | XC_5-10x2M   |                      |             |      |     |     |     |       |             | 76           |                   |
|       | 12mm         | XC_5-10x2-4M |                      |             |      |     |     |     |       |             | 78           |                   |
| 20mm  | XC_6-10x3.3M | 81           |                      |             |      |     |     |     |       |             |              |                   |

† Patent No. 5839321

## Advanced Anti-Backlash Supernuts®

### XC 5000

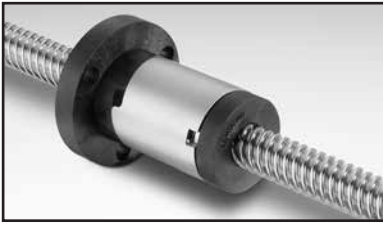

The XC 5000 utilizes the same patented† ActiveCAM™ as found in the XC 3700 model. Along with the very low drag torque and high axial stiffness advantages, the XC 5000 has greater load capacity.

Note: See Screw Section on page 36. Specify XCT, XCB or XCF when ordering, see drawings at right.

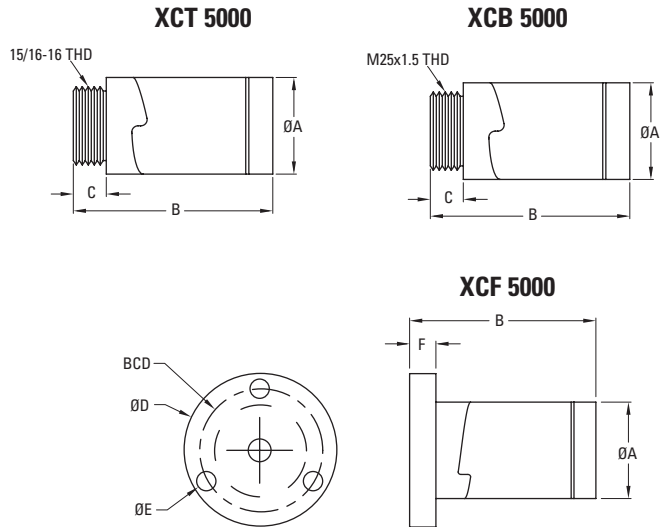

| Dia.  | Lead       | Part No.      | Supernut® Dimensions |            |       |      |     |     |       | Design Load | Efficiency % | Drag Torque oz-in |
|-------|------------|---------------|----------------------|------------|-------|------|-----|-----|-------|-------------|--------------|-------------------|
|       |            |               | A                    | B          | C     | D    | E   | F   | BCD   |             |              |                   |
| 7/16" | 0.125      | XC_2-4316     | 1.12                 | 2.25 (max) | 0.375 | 1.75 | 0.2 | 0.3 | 1.406 | 125 lbs     | 55           | 1 - 3             |
|       | 0.250      | XC_2-4308     |                      |            |       |      |     |     |       |             | 65           |                   |
|       | 0.500      | XC_4-4308     |                      |            |       |      |     |     |       |             | 76           |                   |
| 12mm  | 3mm        | XC_12x3M      | 1.12                 | 2.25 (max) | 0.375 | 1.75 | 0.2 | 0.3 | 1.406 | 125 lbs     | 48           | 1 - 3             |
|       | 4mm        | XC_2-12x2M    |                      |            |       |      |     |     |       |             | 54           |                   |
|       | 5mm        | XC_2-12x2.5M  |                      |            |       |      |     |     |       |             | 59           |                   |
|       | 6mm        | XC_3-12x2M    |                      |            |       |      |     |     |       |             | 63           |                   |
|       | 10mm       | XC_4-12x2.5M  |                      |            |       |      |     |     |       |             | 73           |                   |
|       | 15mm       | XC_6-12x2.5M  |                      |            |       |      |     |     |       |             | 78           |                   |
|       | 25mm       | XC_10-12x2.5M |                      |            |       |      |     |     |       |             | 82           |                   |
|       | 45mm       | XC_15-12x3M   |                      |            |       |      |     |     |       |             | 81           |                   |
| 1/2"  | .0625      | XC_5016       | 1.12                 | 2.25 (max) | 0.375 | 1.75 | 0.2 | 0.3 | 1.406 | 125 lbs     | 30           | 1 - 3             |
|       | 0.100      | XC_5010       |                      |            |       |      |     |     |       |             | 41           |                   |
|       | 4mm        | XC_2-50x2M    |                      |            |       |      |     |     |       |             | 52           |                   |
|       | 0.200      | XC_2-5010     |                      |            |       |      |     |     |       |             | 57           |                   |
|       | 0.250      | XC_2-5008     |                      |            |       |      |     |     |       |             | 62           |                   |
|       | 0.500      | XC_4-5008     |                      |            |       |      |     |     |       |             | 75           |                   |
|       | 0.800      | XC_8-5010     |                      |            |       |      |     |     |       |             | 80           |                   |
|       | 1.000      | XC_8-5008     |                      |            |       |      |     |     |       |             | 81           |                   |
| 1.500 | XC_12-5008 | 82            |                      |            |       |      |     |     |       |             |              |                   |

† Patent No. 5839321

## Advanced Anti-Backlash Supernuts®

### XC 6200

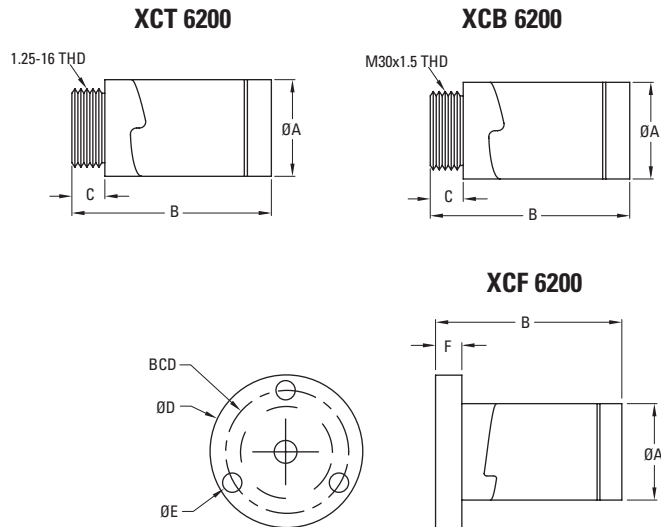

The XC 6200 utilizes the same patented† ActiveCAM™ as found in the XC 5000 model. Along with the very low drag torque and high axial stiffness advantages, the XC 6200 has greater load capacity.

Note: See Screw Section on page 36. Specify XCT, XCB or XCF when ordering, see drawings at right.

| Dia. | Lead  | Part No.     | Supernut® Dimensions |            |     |      |      |     |       | Design Load | Efficiency % | Drag Torque oz-in |
|------|-------|--------------|----------------------|------------|-----|------|------|-----|-------|-------------|--------------|-------------------|
|      |       |              | A                    | B          | C   | D    | E    | F   | BCD   |             |              |                   |
| 5/8" | 0.100 | XC_6210      | 1.40                 | 2.60 (max) | 0.5 | 2.13 | 0.22 | 0.5 | 1.688 | 175 lbs     | 35           | 2 - 6             |
|      | 0.125 | XC_6208      |                      |            |     |      |      |     |       |             | 40           |                   |
|      | 0.200 | XC_2-6210    |                      |            |     |      |      |     |       |             | 51           |                   |
|      | 0.250 | XC_2-6208    |                      |            |     |      |      |     |       |             | 57           |                   |
|      | 0.500 | XC_4-6208    |                      |            |     |      |      |     |       |             | 71           |                   |
| 16mm | 4mm   | XC_16x4M     | 1.40                 | 2.60 (max) | 0.5 | 2.13 | 0.22 | 0.5 | 1.688 | 175 lbs     | 47           | 2 - 6             |
|      | 5mm   | XC_2-16x2.5M |                      |            |     |      |      |     |       |             | 52           |                   |
|      | 8mm   | XC_4-16x2M   |                      |            |     |      |      |     |       |             | 63           |                   |
|      | 16mm  | XC_7-16x2.3M |                      |            |     |      |      |     |       |             | 75           |                   |
|      | 25mm  | XC_5-16x5M   |                      |            |     |      |      |     |       |             | 80           |                   |
|      | 35mm  | XC_7-16x5M   |                      |            |     |      |      |     |       |             | 82           |                   |

† Patent No. 5839321

## Advanced Anti-Backlash Supernuts®

### XC 7500

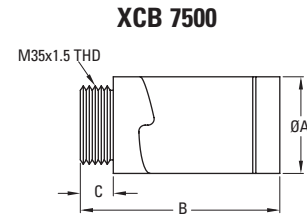
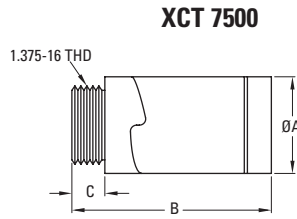

The XC 7500 utilizes the same patented† ActiveCAM™ as found in the XC 5000 model. Along with the very low drag torque and high axial stiffness advantages, the XC 7500 has greater load capacity.

Note: See Screw Section on page 36. Specify XCT, XCB or XCF when ordering, see drawings at right.

### Flange F75

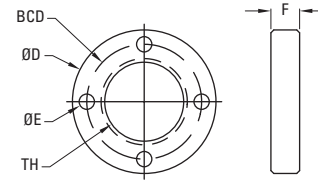

| Dia. | Lead  | Part No.    | Nut Dimensions |           |     | Flange Dimensions (Optional) |      |      |      | Design Load | Efficiency % | Drag Torque oz-in |
|------|-------|-------------|----------------|-----------|-----|------------------------------|------|------|------|-------------|--------------|-------------------|
|      |       |             | A              | B         | C   | D                            | E    | F    | BCD  |             |              |                   |
| 3/4" | 0.100 | XC_7510     | 1.63           | 2.9 (max) | 0.5 | 2.5                          | 0.27 | 0.50 | 2.00 | 250 lbs     | 31           | 3 - 10            |
|      | 0.125 | XC_7508     |                |           |     |                              |      |      |      |             | 36           |                   |
|      | 0.167 | XC_7506     |                |           |     |                              |      |      |      |             | 44           |                   |
|      | 0.200 | XC_7505     |                |           |     |                              |      |      |      |             | 49           |                   |
|      | 0.500 | XC_5-7510   |                |           |     |                              |      |      |      |             | 69           |                   |
|      | 1.000 | XC_8-7508   |                |           |     |                              |      |      |      |             | 79           |                   |
|      | 1.500 | XC_12-7508  |                |           |     |                              |      |      |      |             | 81           |                   |
|      | 2.000 | XC_10-7505  |                |           |     |                              |      |      |      |             | 82           |                   |
| 20mm | 4mm   | XC_20x4M    | 1.63           | 2.9 (max) | 0.5 | 2.5                          | 0.27 | 0.50 | 2.00 | 250 lbs     | 41           | 3 - 10            |
|      | 8mm   | XC_2-20x4M  |                |           |     |                              |      |      |      |             | 59           |                   |
|      | 12mm  | XC_3-20x4M  |                |           |     |                              |      |      |      |             | 67           |                   |
|      | 16mm  | XC_4-20x4M  |                |           |     |                              |      |      |      |             | 72           |                   |
|      | 20mm  | XC_5-20x4M  |                |           |     |                              |      |      |      |             | 76           |                   |
|      | 45mm  | XC_9-20x5M  |                |           |     |                              |      |      |      |             | 82           |                   |
|      | 50mm  | XC_10-20x5M |                |           |     |                              |      |      |      |             | 82           |                   |

† Patent No. 5839321

## Advanced Anti-Backlash Supernuts®

### XC 10000



The XC 10000 utilizes Thomson BSA's patented<sup>†</sup> ActiveCAM™ technology to provide very low drag torque, high axial stiffness and maximum wear life. This self compensating design produces excellent positional repeatability while insuring consistent performance for the long run.

Note: See Screw Section on page 36. Specify XCT, XCB or XCF when ordering, see drawings at right.

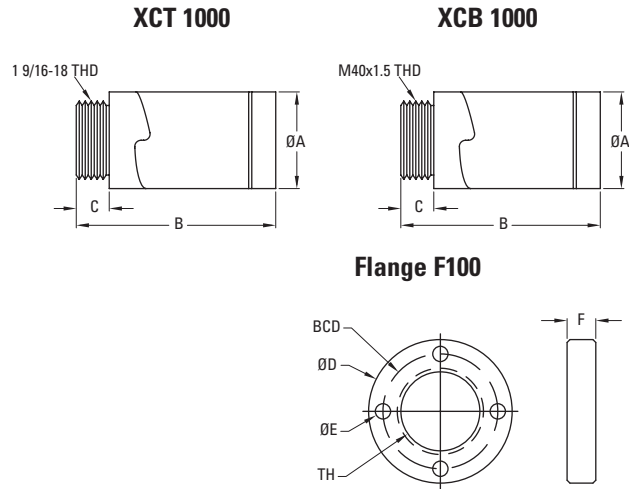

| Dia.  | Lead       | Part No.  | Nut Dimensions |              |      | Flange Dimensions<br>(Optional) |      |      |      | Design Load | Efficiency % | Drag Torque oz-in |
|-------|------------|-----------|----------------|--------------|------|---------------------------------|------|------|------|-------------|--------------|-------------------|
|       |            |           | A              | B            | C    | D                               | E    | F    | BCD  |             |              |                   |
| 24mm  | 5mm        | XC_24x5M  | 1.88           | 3.0<br>(max) | 0.60 | 3.0                             | 0.27 | 0.60 | 2.37 | 350 lbs     | 42           | 5-15              |
| 1"    | 0.100      | XC_1010   | 1.88           | 3.0<br>(max) | 0.60 | 3.0                             | 0.27 | 0.60 | 2.37 | 350 lbs     | 25           | 5-15              |
|       | 0.125      | XC_1008   |                |              |      |                                 |      |      |      |             | 29           |                   |
|       | 0.200      | XC_1005   |                |              |      |                                 |      |      |      |             | 41           |                   |
|       | 0.250      | XC_2-1008 |                |              |      |                                 |      |      |      |             | 46           |                   |
|       | 0.250      | XC_1004   |                |              |      |                                 |      |      |      |             | 47           |                   |
|       | 0.500      | XC_5-1010 |                |              |      |                                 |      |      |      |             | 61           |                   |
| 1.000 | XC_10-1010 | 74        |                |              |      |                                 |      |      |      |             |              |                   |

† Patent No. 5839321

## Advanced Anti-Backlash Supernuts®

### AFT

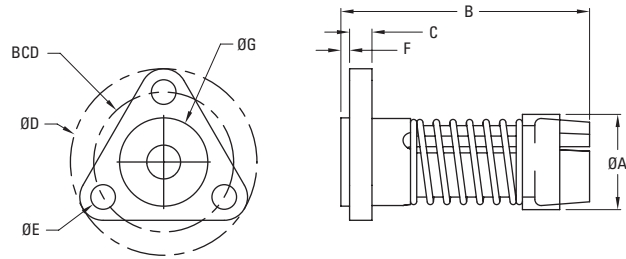

The low cost AFT Supernut is designed for light load OEM applications and offers smooth movement and low drag torque for axial loads up to 10 pounds. The AFT anti-backlash collar automatically adjusts for wear for the life of the nut.

| Dia.  | Lead      | Part No.     | Supernut® Dimensions |      |      |      |      |      |      |       | Design Load | Efficiency % | Drag Torque oz-in |
|-------|-----------|--------------|----------------------|------|------|------|------|------|------|-------|-------------|--------------|-------------------|
|       |           |              | A                    | B    | C    | D    | E    | F    | G    | BCD   |             |              |                   |
| 3/8"  | 0.050     | AFT3720      | 0.77                 | 2.00 | 0.20 | 1.50 | 0.20 | 0.06 | 0.71 | 1.125 | 10 lbs      | 32           | 2 - 5             |
|       | 0.063     | AFT3716      |                      |      |      |      |      |      |      |       |             | 36           |                   |
|       | 2mm       | AFT37x2M     |                      |      |      |      |      |      |      |       |             | 42           |                   |
|       | 0.083     | AFT3712      |                      |      |      |      |      |      |      |       |             | 44           |                   |
|       | 0.100     | AFT3710      |                      |      |      |      |      |      |      |       |             | 49           |                   |
|       | 0.125     | AFT3708      |                      |      |      |      |      |      |      |       |             | 53           |                   |
|       | 0.167     | AFT2-3712    |                      |      |      |      |      |      |      |       |             | 60           |                   |
|       | 0.200     | AFT2-3710    |                      |      |      |      |      |      |      |       |             | 65           |                   |
|       | 0.250     | AFT2-3708    |                      |      |      |      |      |      |      |       |             | 68           |                   |
|       | 0.300     | AFT3-3710    |                      |      |      |      |      |      |      |       |             | 73           |                   |
|       | 0.375     | AFT4-3711    |                      |      |      |      |      |      |      |       |             | 75           |                   |
|       | 0.500     | AFT4-3708    |                      |      |      |      |      |      |      |       |             | 79           |                   |
|       | 0.750     | AFT6-3708    |                      |      |      |      |      |      |      |       |             | 82           |                   |
| 1.000 | AFT5-3705 | 82           |                      |      |      |      |      |      |      |       |             |              |                   |
| 1.200 | AFT5-3704 | 82           |                      |      |      |      |      |      |      |       |             |              |                   |
| 10mm  | 2mm       | AFT10x2M     | 0.77                 | 2.00 | 0.20 | 1.50 | 0.20 | 0.06 | 0.71 | 1.125 | 10 lbs      | 41           | 2 - 5             |
|       | 3mm       | AFT10x3M     |                      |      |      |      |      |      |      |       |             | 53           |                   |
|       | 4mm       | AFT2-10x2M   |                      |      |      |      |      |      |      |       |             | 59           |                   |
|       | 5mm       | AFT2-10x2.5M |                      |      |      |      |      |      |      |       |             | 64           |                   |
|       | 6mm       | AFT4-10x1.5M |                      |      |      |      |      |      |      |       |             | 67           |                   |
|       | 10mm      | AFT5-10x2M   |                      |      |      |      |      |      |      |       |             | 76           |                   |
|       | 12mm      | AFT5-10x2.4M |                      |      |      |      |      |      |      |       |             | 78           |                   |
|       | 20mm      | AFT6-10x3.3M |                      |      |      |      |      |      |      |       |             | 81           |                   |
| 7/16" | 0.125     | AFT2-4316    | 0.77                 | 2.00 | 0.20 | 1.50 | 0.20 | 0.06 | 0.71 | 1.125 | 10 lbs      | 55           | 2 - 5             |
|       | 0.250     | AFT2-4308    |                      |      |      |      |      |      |      |       |             | 65           |                   |
|       | 0.500     | AFT4-4308    |                      |      |      |      |      |      |      |       |             | 76           |                   |
| 1/2"  | 0.063     | AFT5016      | 0.88                 | 2.03 | 0.25 | 1.62 | 0.20 | -    | -    | 1.250 | 25 lbs      | 30           | 3 - 7             |
|       | 0.100     | AFT5010      |                      |      |      |      |      |      |      |       |             | 41           |                   |
|       | 4mm       | AFT2-50x2M   |                      |      |      |      |      |      |      |       |             | 52           |                   |
|       | 0.200     | AFT2-5010    |                      |      |      |      |      |      |      |       |             | 57           |                   |
|       | 0.250     | AFT2-5008    |                      |      |      |      |      |      |      |       |             | 62           |                   |
|       | 0.500     | AFT4-5008    |                      |      |      |      |      |      |      |       |             | 75           |                   |
|       | 0.800     | AFT8-5010    |                      |      |      |      |      |      |      |       |             | 80           |                   |
|       | 1.000     | AFT8-5008    |                      |      |      |      |      |      |      |       |             | 81           |                   |

# Anti-Backlash Supernuts®

## SNAB Thread Mount Style

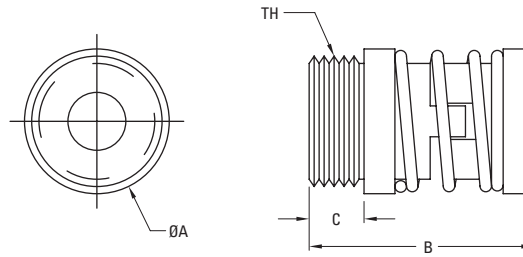
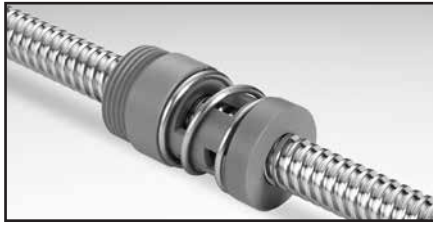

Our SNAB Model has the greatest design flexibility allowing anti-backlash assemblies through 1" diameters. All SNABs are made from our internally lubricated Acetal providing excellent lubricity and very low wear.

SNAB\* - 3/16" to 3/8" (10mm) Diameter

### Flanges

|                      |     |
|----------------------|-----|
| 3/16" to 1/4"        | F25 |
| 5/16" to 3/8" (10mm) | F37 |

Dimensions available on page 35.

| Dia.  | Lead         | Part No.      | Supernut® Dimensions |         |         |       |         | Preload Force (lbs) | Design Load | Max Static Load | Efficiency % | Drag Torque oz-in |
|-------|--------------|---------------|----------------------|---------|---------|-------|---------|---------------------|-------------|-----------------|--------------|-------------------|
|       |              |               | A                    | B (min) | B (max) | C     | TH      |                     |             |                 |              |                   |
| 3/16" | 0.050        | SNAB1820X     | 0.625                | 1.125   | 1.250   | 0.187 | 9/16-18 | 1-3                 | 10 lbs      | 150 lbs         | 49           | 2 - 4             |
|       | 0.100        | SNAB2-1820X   |                      |         |         |       |         |                     |             |                 | 66           |                   |
|       | 0.125        | SNAB3-1824X   |                      |         |         |       |         |                     |             |                 | 70           |                   |
|       | 0.200        | SNAB4-1820X   |                      |         |         |       |         |                     |             |                 | 77           |                   |
|       | 0.375        | SNAB8-1821X   |                      |         |         |       |         |                     |             |                 | 81           |                   |
|       | 0.400        | SNAB8-1820X   |                      |         |         |       |         |                     |             |                 | 82           |                   |
| 0.500 | SNAB10-1820X | 82            |                      |         |         |       |         |                     |             |                 |              |                   |
| 6mm   | 1mm          | SNAB6x1M      | 0.625                | 1.125   | 1.250   | 0.187 | 9/16-18 | 1-3                 | 10 lbs      | 150 lbs         | 37           | 2 - 4             |
| 1/4"  | 0.031        | SNAB2532X     | 0.625                | 1.125   | 1.250   | 0.187 | 9/16-18 | 1-3                 | 25 lbs      | 225 lbs         | 30           | 2 - 4             |
|       | 0.050        | SNAB2520X     |                      |         |         |       |         |                     |             |                 | 41           |                   |
|       | 0.063        | SNAB2516X     |                      |         |         |       |         |                     |             |                 | 48           |                   |
|       | 2mm          | SNAB2-25x1M   |                      |         |         |       |         |                     |             |                 | 53           |                   |
|       | 3mm          | SNAB3-25x1M   |                      |         |         |       |         |                     |             |                 | 62           |                   |
|       | 0.125        | SNAB2-2516X   |                      |         |         |       |         |                     |             |                 | 64           |                   |
|       | 0.200        | SNAB4-2520X   |                      |         |         |       |         |                     |             |                 | 72           |                   |
|       | 0.250        | SNAB4-2516X   |                      |         |         |       |         |                     |             |                 | 76           |                   |
|       | 0.500        | SNAB7-2514X   |                      |         |         |       |         |                     |             |                 | 81           |                   |
|       | 0.750        | SNAB12-2516X  |                      |         |         |       |         |                     |             |                 | 82           |                   |
| 5/16" | 0.083        | SNAB3112X     | 0.750                | 1.160   | 1.340   | 0.250 | 5/8-18  | 2-5                 | 50 lbs      | 350 lbs         | 49           | 2 - 4             |
|       | 0.167        | SNAB2-3112X   |                      |         |         |       |         |                     |             |                 | 65           |                   |
|       | 0.250        | SNAB2-3108X   |                      |         |         |       |         |                     |             |                 | 72           |                   |
|       | 0.500        | SNAB4-3108X   |                      |         |         |       |         |                     |             |                 | 80           |                   |
|       | 1.000        | SNAB8-3108X   |                      |         |         |       |         |                     |             |                 | 81           |                   |
| 3/8"  | 0.050        | SNAB3720X     | 0.750                | 1.160   | 1.340   | 0.250 | 5/8-18  | 2-5                 | 70 lbs      | 350 lbs         | 32           | 2 - 4             |
|       | 0.063        | SNAB3716X     |                      |         |         |       |         |                     |             |                 | 36           |                   |
|       | 2mm          | SNAB37x2M     |                      |         |         |       |         |                     |             |                 | 42           |                   |
|       | 0.083        | SNAB3712X     |                      |         |         |       |         |                     |             |                 | 44           |                   |
|       | 0.100        | SNAB3710X     |                      |         |         |       |         |                     |             |                 | 49           |                   |
|       | 0.125        | SNAB3708X     |                      |         |         |       |         |                     |             |                 | 53           |                   |
|       | 0.167        | SNAB2-3712X   |                      |         |         |       |         |                     |             |                 | 60           |                   |
|       | 0.200        | SNAB2-3710X   |                      |         |         |       |         |                     |             |                 | 65           |                   |
|       | 0.250        | SNAB2-3708X   |                      |         |         |       |         |                     |             |                 | 68           |                   |
|       | 0.300        | SNAB3-3710X   |                      |         |         |       |         |                     |             |                 | 73           |                   |
|       | 0.375        | SNAB4-3711X   |                      |         |         |       |         |                     |             |                 | 75           |                   |
|       | 0.500        | SNAB4-3708X   |                      |         |         |       |         |                     |             |                 | 79           |                   |
|       | 0.750        | SNAB6-3708X   |                      |         |         |       |         |                     |             |                 | 82           |                   |
|       | 1.000        | SNAB5-3705X   |                      |         |         |       |         |                     |             |                 | 82           |                   |
|       | 1.200        | SNAB5-3704X   |                      |         |         |       |         |                     |             |                 | 82           |                   |
| 10mm  | 2mm          | SNAB10x2M     | 0.750                | 1.160   | 1.340   | 0.250 | 5/8-18  | 2-5                 | 70 lbs      | 350 lbs         | 41           | 2 - 4             |
|       | 3mm          | SNAB10x3M     |                      |         |         |       |         |                     |             |                 | 53           |                   |
|       | 4mm          | SNAB2-10x2M   |                      |         |         |       |         |                     |             |                 | 59           |                   |
|       | 5mm          | SNAB2-10x2.5M |                      |         |         |       |         |                     |             |                 | 64           |                   |
|       | 6mm          | SNAB4-10x1.5M |                      |         |         |       |         |                     |             |                 | 67           |                   |
|       | 10mm         | SNAB5-10x2M   |                      |         |         |       |         |                     |             |                 | 76           |                   |
|       | 12mm         | SNAB5-10x2.4M |                      |         |         |       |         |                     |             |                 | 78           |                   |
|       | 20mm         | SNAB6-10x3.3M |                      |         |         |       |         |                     |             |                 | 81           |                   |

\* SNAB nuts are only as axially stiff as the spring force in one direction.

## Anti-Backlash Supernuts®

### SNAB Thread Mount Style



### Flanges

|                      |     |
|----------------------|-----|
| 7/16" to 5/8" (16mm) | F50 |
|----------------------|-----|

Dimensions available on page 35.

### SNAB\*

#### 7/16" to 5/8" (16mm) Diameter

| Dia.  | Lead   | Part No.       | Supernut® Dimensions |         |         |       |          | Preload Force (lbs) | Design Load | Max Static Load | Efficiency % | Drag Torque oz-in |
|-------|--------|----------------|----------------------|---------|---------|-------|----------|---------------------|-------------|-----------------|--------------|-------------------|
|       |        |                | A                    | B (min) | B (max) | C     | TH       |                     |             |                 |              |                   |
| 7/16" | 0.125  | SNAB2-4316X    | 1.000                | 1.700   | 2.000   | 0.375 | 15/16-16 | 4-9                 | 100 lbs     | 500 lbs         | 55           | 3 - 5             |
|       | 0.250  | SNAB2-4308X    |                      |         |         |       |          |                     |             |                 | 65           |                   |
|       | 0.500  | SNAB4-4308X    |                      |         |         |       |          |                     |             |                 | 76           |                   |
| 12mm  | 3mm    | SNAB12x3M      | 1.000                | 1.700   | 2.000   | 0.375 | 15/16-16 | 4-9                 | 100 lbs     | 500 lbs         | 48           | 3 - 5             |
|       | 4mm    | SNAB2-12x2M    |                      |         |         |       |          |                     |             |                 | 54           |                   |
|       | 5mm    | SNAB2-12x2.5M  |                      |         |         |       |          |                     |             |                 | 59           |                   |
|       | 6mm    | SNAB3-12x2M    |                      |         |         |       |          |                     |             |                 | 63           |                   |
|       | 10mm   | SNAB4-12x2.5M  |                      |         |         |       |          |                     |             |                 | 73           |                   |
|       | 15mm   | SNAB6-12x2.5M  |                      |         |         |       |          |                     |             |                 | 78           |                   |
|       | 25mm   | SNAB10-12x2.5M |                      |         |         |       |          |                     |             |                 | 82           |                   |
|       | 45mm   | SNAB15-12x3M   |                      |         |         |       |          |                     |             |                 | 81           |                   |
| 1/2"  | 0.0625 | SNAB5016X      | 1.000                | 1.700   | 2.000   | 0.375 | 15/16-16 | 4-9                 | 150 lbs     | 750 lbs         | 30           | 5 - 8             |
|       | 0.100  | SNAB5010X      |                      |         |         |       |          |                     |             |                 | 41           |                   |
|       | 4mm    | SNAB2-50x2M    |                      |         |         |       |          |                     |             |                 | 52           |                   |
|       | 0.200  | SNAB2-5010X    |                      |         |         |       |          |                     |             |                 | 57           |                   |
|       | 0.250  | SNAB2-5008X    |                      |         |         |       |          |                     |             |                 | 62           |                   |
|       | 0.500  | SNAB4-5008X    |                      |         |         |       |          |                     |             |                 | 75           |                   |
|       | 0.800  | SNAB8-5010X    |                      |         |         |       |          |                     |             |                 | 80           |                   |
|       | 1.000  | SNAB8-5008X    |                      |         |         |       |          |                     |             |                 | 81           |                   |
|       | 1.500  | SNAB12-5008X   |                      |         |         |       |          |                     |             |                 | 82           |                   |
| 5/8"  | 0.100  | SNAB6210X      | 1.000                | 1.700   | 2.000   | 0.375 | 15/16-16 | 4-9                 | 160 lbs     | 800 lbs         | 35           | 7 - 10            |
|       | 0.125  | SNAB6208X      |                      |         |         |       |          |                     |             |                 | 40           |                   |
|       | 0.200  | SNAB2-6210X    |                      |         |         |       |          |                     |             |                 | 51           |                   |
|       | 0.250  | SNAB2-6208X    |                      |         |         |       |          |                     |             |                 | 57           |                   |
|       | 0.500  | SNAB4-6208X    |                      |         |         |       |          |                     |             |                 | 71           |                   |
| 16mm  | 4mm    | SNAB16x4M      | 1.000                | 1.700   | 2.000   | 0.375 | 15/16-16 | 4-9                 | 160 lbs     | 800 lbs         | 47           | 7 - 10            |
|       | 5mm    | SNAB2-16x2.5M  |                      |         |         |       |          |                     |             |                 | 52           |                   |
|       | 8mm    | SNAB4-16x2M    |                      |         |         |       |          |                     |             |                 | 63           |                   |
|       | 16mm   | SNAB7-16x2.3M  |                      |         |         |       |          |                     |             |                 | 75           |                   |
|       | 25mm   | SNAB5-16x5M    |                      |         |         |       |          |                     |             |                 | 80           |                   |
|       | 35mm   | SNAB7-16x5M    |                      |         |         |       |          |                     |             |                 | 82           |                   |

\* SNAB nuts are only as axially stiff as the spring force in one direction.



## Anti-Backlash Supernuts®

### SNAB Thread Mount Style

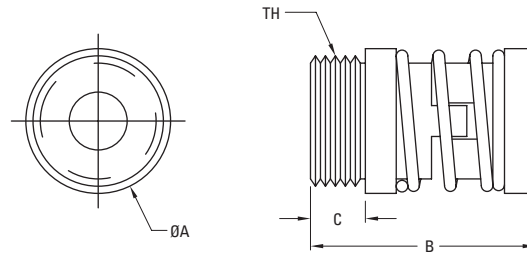

#### Flanges

|            |      |
|------------|------|
| 3/4" to 1" | F100 |
|------------|------|

Dimensions available on page 35.

### SNAB\* 3/4" to 1" Diameter

| Dia. | Lead  | Part No.     | Supernut® Dimensions |         |         |       |             | Preload Force (lbs) | Design Load | Max Static Load | Efficiency % | Drag Torque oz-in |
|------|-------|--------------|----------------------|---------|---------|-------|-------------|---------------------|-------------|-----------------|--------------|-------------------|
|      |       |              | A                    | B (min) | B (max) | C     | TH          |                     |             |                 |              |                   |
| 3/4" | 0.100 | SNAB7510X    | 1.750                | 2.500   | 3.000   | 0.600 | 1-9/16 - 18 | 10-20               | 300 lbs     | 1500 lbs        | 31           | 15 - 20           |
|      | 0.125 | SNAB7508X    |                      |         |         |       |             |                     |             |                 | 36           |                   |
|      | 0.167 | SNAB7506X    |                      |         |         |       |             |                     |             |                 | 44           |                   |
|      | 0.200 | SNAB7505X    |                      |         |         |       |             |                     |             |                 | 49           |                   |
|      | 0.500 | SNAB5-7510X  |                      |         |         |       |             |                     |             |                 | 69           |                   |
|      | 1.000 | SNAB8-7508X  |                      |         |         |       |             |                     |             |                 | 79           |                   |
|      | 1.500 | SNAB12-7508X |                      |         |         |       |             |                     |             |                 | 81           |                   |
|      | 2.000 | SNAB10-7505X |                      |         |         |       |             |                     |             |                 | 82           |                   |
| 20mm | 4mm   | SNAB20x4M    | 1.750                | 2.500   | 3.000   | 0.600 | 1-9/16 - 18 | 10-20               | 300 lbs     | 1500 lbs        | 41           | 15 - 20           |
|      | 8mm   | SNAB2-20x4M  |                      |         |         |       |             |                     |             |                 | 59           |                   |
|      | 12mm  | SNAB3-20x4M  |                      |         |         |       |             |                     |             |                 | 67           |                   |
|      | 16mm  | SNAB4-20x4M  |                      |         |         |       |             |                     |             |                 | 72           |                   |
|      | 20mm  | SNAB5-20x4M  |                      |         |         |       |             |                     |             |                 | 76           |                   |
|      | 45mm  | SNAB9-20x5M  |                      |         |         |       |             |                     |             |                 | 82           |                   |
| 24mm | 5mm   | SNAB24x5M    | 1.750                | 2.500   | 3.000   | 0.600 | 1-9/16 - 18 | 10-20               | 300 lbs     | 1500 lbs        | 42           | 15 - 20           |
| 1"   | 0.100 | SNAB1010X    | 1.750                | 2.500   | 3.000   | 0.600 | 1-9/16 - 18 | 10-20               | 400 lbs     | 2000 lbs        | 25           | 15 - 20           |
|      | 0.125 | SNAB1008X    |                      |         |         |       |             |                     |             |                 | 29           |                   |
|      | 0.200 | SNAB1005X    |                      |         |         |       |             |                     |             |                 | 41           |                   |
|      | 0.250 | SNAB2-1008X  |                      |         |         |       |             |                     |             |                 | 46           |                   |
|      | 0.250 | SNAB1004X    |                      |         |         |       |             |                     |             |                 | 47           |                   |
|      | 0.500 | SNAB5-1010X  |                      |         |         |       |             |                     |             |                 | 61           |                   |
|      | 1.000 | SNAB10-1010X |                      |         |         |       |             |                     |             |                 | 74           |                   |

\* SNAB nuts are only as axially stiff as the spring force in one direction.

## Flange Mount Supernuts®

MTS

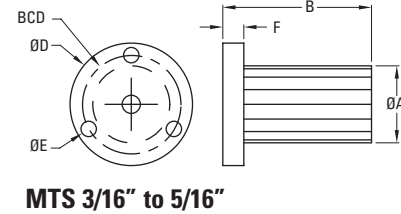
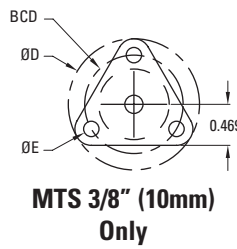
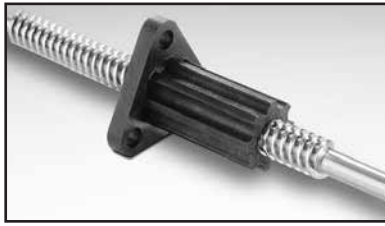

### Integral Flange Mount

The MTS models provide the excellent lubricity and dimensional stability of our proprietary Acetal with the convenience of an integral flange.

### MTS - 3/16" to 3/8" (10mm) Diameter

| Dia.  | Lead       | Part No.     | Supernut® Dimensions |      |      |      |       |       | Design Load | Efficiency % | Drag Torque oz-in |
|-------|------------|--------------|----------------------|------|------|------|-------|-------|-------------|--------------|-------------------|
|       |            |              | A                    | B    | D    | E    | F     | BCD   |             |              |                   |
| 3/16" | 0.050      | MTS1820      | 0.50                 | 0.75 | 1.00 | 0.14 | 0.15  | 0.75  | 10 lbs      | 49           | Free Wheeling     |
|       | 0.100      | MTS2-1820    |                      |      |      |      |       |       |             | 66           |                   |
|       | 0.125      | MTS3-1824    |                      |      |      |      |       |       |             | 70           |                   |
|       | 0.200      | MTS4-1820    |                      |      |      |      |       |       |             | 77           |                   |
|       | 0.375      | MTS8-1821    |                      |      |      |      |       |       |             | 81           |                   |
|       | 0.400      | MTS8-1820    |                      |      |      |      |       |       |             | 82           |                   |
| 0.500 | MTS10-1820 | 82           |                      |      |      |      |       |       |             |              |                   |
| 6mm   | 1mm        | MTS6x1M      | 0.50                 | 0.75 | 1.00 | 0.14 | 0.15  | 0.75  | 10 lbs      | 37           | Free Wheeling     |
| 1/4"  | 0.031      | MTS2532      | 0.50                 | 0.75 | 1.00 | 0.14 | 0.15  | 0.75  | 25 lbs      | 30           | Free Wheeling     |
|       | 0.050      | MTS2520      |                      |      |      |      |       |       |             | 41           |                   |
|       | 0.063      | MTS2516      |                      |      |      |      |       |       |             | 48           |                   |
|       | 2mm        | MTS2-25x1M   |                      |      |      |      |       |       |             | 53           |                   |
|       | 3mm        | MTS3-25x1M   |                      |      |      |      |       |       |             | 62           |                   |
|       | 0.125      | MTS2-2516    |                      |      |      |      |       |       |             | 64           |                   |
|       | 0.200      | MTS4-2520    |                      |      |      |      |       |       |             | 72           |                   |
|       | 0.250      | MTS4-2516    |                      |      |      |      |       |       |             | 76           |                   |
|       | 0.500      | MTS7-2514    |                      |      |      |      |       |       |             | 81           |                   |
| 0.750 | MTS12-2516 | 82           |                      |      |      |      |       |       |             |              |                   |
| 5/16" | 0.083      | MTS3112      | 0.50                 | 0.75 | 1.00 | 0.14 | 0.15  | 0.75  | 50 lbs      | 49           | Free Wheeling     |
|       | 0.167      | MTS2-3112    |                      |      |      |      |       |       |             | 65           |                   |
|       | 0.250      | MTS2-3108    |                      |      |      |      |       |       |             | 72           |                   |
|       | 0.500      | MTS4-3108    |                      |      |      |      |       |       |             | 80           |                   |
|       | 1.000      | MTS8-3108    |                      |      |      |      |       |       |             | 81           |                   |
| 3/8"* | 0.050      | MTS3720      | 0.71                 | 1.50 | 1.5  | 0.20 | 0.20  | 1.125 | 60 lbs      | 32           | Free Wheeling     |
|       | 0.063      | MTS3716      |                      |      |      |      |       |       |             | 36           |                   |
|       | 2mm        | MTS37x2M     |                      |      |      |      |       |       |             | 42           |                   |
|       | 0.083      | MTS3712      |                      |      |      |      |       |       |             | 44           |                   |
|       | 0.100      | MTS3710      |                      |      |      |      |       |       |             | 49           |                   |
|       | 0.125      | MTS3708      |                      |      |      |      |       |       |             | 53           |                   |
|       | 0.167      | MTS2-3712    |                      |      |      |      |       |       |             | 60           |                   |
|       | 0.200      | MTS2-3710    |                      |      |      |      |       |       |             | 65           |                   |
|       | 0.250      | MTS2-3708    |                      |      |      |      |       |       |             | 68           |                   |
|       | 0.300      | MTS3-3710    |                      |      |      |      |       |       |             | 73           |                   |
|       | 0.375      | MTS4-3711    |                      |      |      |      |       |       |             | 75           |                   |
|       | 0.500      | MTS4-3708    |                      |      |      |      |       |       |             | 79           |                   |
|       | 0.750      | MTS6-3708    |                      |      |      |      |       |       |             | 82           |                   |
|       | 1.000      | MTS5-3705    |                      |      |      |      |       |       |             | 82           |                   |
|       | 1.200      | MTS5-3704    |                      |      |      |      |       |       |             | 82           |                   |
| 10mm* | 2mm        | MTS10x2M     | 0.71                 | 1.50 | 1.5  | 0.2  | 0.200 | 1.125 | 75 lbs      | 41           | Free Wheeling     |
|       | 3mm        | MTS10x3M     |                      |      |      |      |       |       |             | 53           |                   |
|       | 4mm        | MTS2-10x2M   |                      |      |      |      |       |       |             | 59           |                   |
|       | 5mm        | MTS2-10x2.5M |                      |      |      |      |       |       |             | 64           |                   |
|       | 6mm        | MTS4-10x1.5M |                      |      |      |      |       |       |             | 67           |                   |
|       | 10mm       | MTS5-10x2M   |                      |      |      |      |       |       |             | 76           |                   |
|       | 12mm       | MTS5-10x2.4M |                      |      |      |      |       |       |             | 78           |                   |
|       | 20mm       | MTS6-10x3.3M |                      |      |      |      |       |       |             | 81           |                   |

\* 3/8" and 10mm with tri-flange

## Flange Mount Supernuts®

MTS

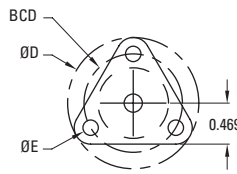
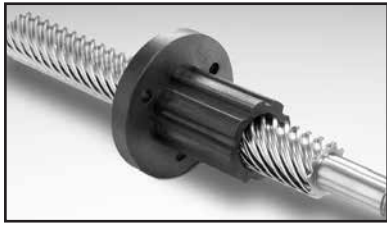

MTS 7/16" Only

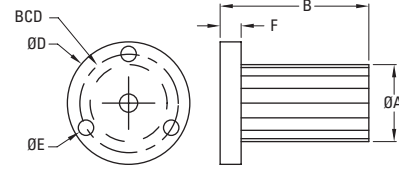

MTS 12mm to 5/8" (16mm)

MTS

7/16" to 5/8" (16mm) Diameter

| Dia.   | Lead        | Part No.      | Supernut® Dimensions |      |     |      |       |       | Design Load | Efficiency % | Drag Torque oz-in |
|--------|-------------|---------------|----------------------|------|-----|------|-------|-------|-------------|--------------|-------------------|
|        |             |               | A                    | B    | D   | E    | F     | BCD   |             |              |                   |
| 7/16"* | 0.125       | MTS2-4316     | 0.71                 | 1.50 | 1.5 | 0.20 | 0.200 | 1.125 | 75 lbs      | 55           | Free Wheeling     |
|        | 0.250       | MTS2-4308     |                      |      |     |      |       |       |             | 65           |                   |
|        | 0.500       | MTS4-4308     |                      |      |     |      |       |       |             | 76           |                   |
| 12mm   | 3mm         | MTS12x3M      | 0.75                 | 1.50 | 1.5 | 0.20 | 0.250 | 1.125 | 125 lbs     | 48           | Free Wheeling     |
|        | 4mm         | MTS2-12x2M    |                      |      |     |      |       |       |             | 54           |                   |
|        | 5mm         | MTS2-12x2.5M  |                      |      |     |      |       |       |             | 59           |                   |
|        | 6mm         | MTS3-12x2M    |                      |      |     |      |       |       |             | 63           |                   |
|        | 10mm        | MTS4-12x2.5M  |                      |      |     |      |       |       |             | 73           |                   |
|        | 15mm        | MTS6-12x2.5M  |                      |      |     |      |       |       |             | 78           |                   |
|        | 25mm        | MTS10-12x2.5M |                      |      |     |      |       |       |             | 82           |                   |
| 45mm   | MTS15-12x3M | 81            |                      |      |     |      |       |       |             |              |                   |
| 1/2"   | 0.0625      | MTS5016       | 0.75                 | 1.50 | 1.5 | 0.20 | 0.250 | 1.125 | 125 lbs     | 30           | Free Wheeling     |
|        | 0.100       | MTS5010       |                      |      |     |      |       |       |             | 41           |                   |
|        | 4mm         | MTS2-50x2M    |                      |      |     |      |       |       |             | 52           |                   |
|        | 0.200       | MTS2-5010     |                      |      |     |      |       |       |             | 57           |                   |
|        | 0.250       | MTS2-5008     |                      |      |     |      |       |       |             | 62           |                   |
|        | 0.500       | MTS4-5008     |                      |      |     |      |       |       |             | 75           |                   |
|        | 0.800       | MTS8-5010     |                      |      |     |      |       |       |             | 80           |                   |
|        | 1.000       | MTS8-5008     |                      |      |     |      |       |       |             | 81           |                   |
| 1.500  | MTS12-5008  | 82            |                      |      |     |      |       |       |             |              |                   |
| 5/8"   | 0.100       | MTS6210       | 0.88                 | 1.63 | 1.5 | 0.20 | 0.300 | 1.188 | 175 lbs     | 35           | Free Wheeling     |
|        | 0.125       | MTS6208       |                      |      |     |      |       |       |             | 40           |                   |
|        | 0.200       | MTS2-6210     |                      |      |     |      |       |       |             | 51           |                   |
|        | 0.250       | MTS2-6208     |                      |      |     |      |       |       |             | 57           |                   |
|        | 0.500       | MTS4-6208     |                      |      |     |      |       |       |             | 71           |                   |
| 16mm   | 4mm         | MTS16x4M      | 0.88                 | 1.63 | 1.5 | 0.20 | 0.300 | 1.188 | 175 lbs     | 47           | Free Wheeling     |
|        | 5mm         | MTS2-16x2.5M  |                      |      |     |      |       |       |             | 52           |                   |
|        | 8mm         | MTS4-16x2M    |                      |      |     |      |       |       |             | 63           |                   |
|        | 16mm        | MTS7-16x2.3M  |                      |      |     |      |       |       |             | 75           |                   |
|        | 25mm        | MTS5-16x5M    |                      |      |     |      |       |       |             | 80           |                   |
|        | 35mm        | MTS7-16x5M    |                      |      |     |      |       |       |             | 82           |                   |

\* 7/16" with tri-flange

## Flange Mount Supernuts®

MTS

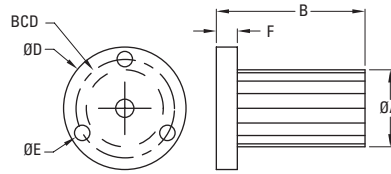
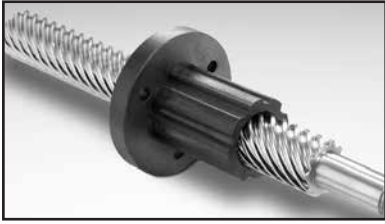

**MTS 3/4" (20mm)**

MTS

3/4" (20mm) Diameter

| Dia. | Lead  | Part No.    | Supernut® Dimensions |      |     |      |       |       | Design Load | Efficiency % | Drag Torque oz-in |
|------|-------|-------------|----------------------|------|-----|------|-------|-------|-------------|--------------|-------------------|
|      |       |             | A                    | B    | D   | E    | F     | BCD   |             |              |                   |
| 3/4" | 0.100 | MTS7510     | 1.125                | 1.75 | 2.0 | 0.20 | 0.300 | 1.438 | 275 lbs     | 31           | Free Wheeling     |
|      | 0.125 | MTS7508     |                      |      |     |      |       |       |             | 36           |                   |
|      | 0.167 | MTS7506     |                      |      |     |      |       |       |             | 44           |                   |
|      | 0.200 | MTS7505     |                      |      |     |      |       |       |             | 49           |                   |
|      | 0.500 | MTS5-7510   |                      |      |     |      |       |       |             | 69           |                   |
|      | 1.000 | MTS8-7508   |                      |      |     |      |       |       |             | 79           |                   |
|      | 1.500 | MTS12-7508  |                      |      |     |      |       |       |             | 81           |                   |
|      | 2.000 | MTS10-7505  |                      |      |     |      |       |       |             | 82           |                   |
| 20mm | 4mm   | MTS20x4M    | 1.125                | 1.75 | 2.0 | 0.20 | 0.300 | 1.438 | 275 lbs     | 42           | Free Wheeling     |
|      | 8mm   | MTS2-20x4M  |                      |      |     |      |       |       |             | 59           |                   |
|      | 12mm  | MTS3-20x4M  |                      |      |     |      |       |       |             | 67           |                   |
|      | 16mm  | MTS4-20x4M  |                      |      |     |      |       |       |             | 72           |                   |
|      | 20mm  | MTS5-20x4M  |                      |      |     |      |       |       |             | 76           |                   |
|      | 45mm  | MTS9-20x5M  |                      |      |     |      |       |       |             | 82           |                   |
|      | 50mm  | MTS10-20x5M |                      |      |     |      |       |       |             | 82           |                   |

## Thread Mount Supernuts®

SN

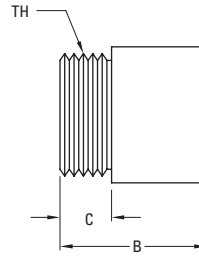
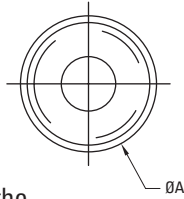
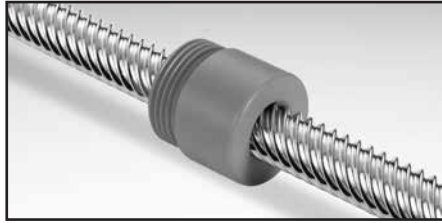

### Flanges

|               |       |
|---------------|-------|
| 3/16" to 1/4" | F25   |
| 5/16" to 10mm | F37   |
| 7/16" to 16mm | F50   |
| 3/4" to 1"    | F75   |
| 1-1/4"        | F100  |
| 1-1/2"        | R54-3 |

Dimensions available on page 35 or online.

Our standard SN nuts have proven themselves for the past twenty years. Available in sizes from 3/16" to 1-1/2" with or without mounting flanges.

SN - 3/16" to 7/16" Diameter\*

| Dia.  | Lead      | Part No.    | Supernut® Dimensions |       |       |          | Design Load | Max. Static Load | Efficiency % | Flange |
|-------|-----------|-------------|----------------------|-------|-------|----------|-------------|------------------|--------------|--------|
|       |           |             | A                    | B     | C     | TH       |             |                  |              |        |
| 3/16" | 0.050     | SN1820X     | 0.625                | 0.500 | 0.187 | 9/16-18  | 30 lbs      | 150 lbs          | 49           | F25    |
|       | 0.100     | SN2-1820    |                      |       |       |          |             |                  | 66           |        |
|       | 0.125     | SN3-1824X   |                      |       |       |          |             |                  | 70           |        |
|       | 0.200     | SN4-1820    |                      |       |       |          |             |                  | 77           |        |
|       | 0.375     | SN8-1821    |                      |       |       |          |             |                  | 81           |        |
|       | 0.400     | SN8-1820    |                      |       |       |          |             |                  | 82           |        |
| 0.500 | SN10-1820 | 82          |                      |       |       |          |             |                  |              |        |
| 6mm   | 1mm       | SN6x1M      | 0.625                | 0.500 | 0.187 | 9/16-18  | 30 lbs      | 150 lbs          | 37           | F25    |
| 1/4"  | 0.031     | SN2532X     | 0.625                | 0.500 | 0.187 | 9/16-18  | 45 lbs      | 225 lbs          | 30           | F25    |
|       | 0.050     | SN2520X     |                      |       |       |          |             |                  | 41           |        |
|       | 0.063     | SN2516X     |                      |       |       |          |             |                  | 48           |        |
|       | 2mm       | SN2-25x1M   |                      |       |       |          |             |                  | 53           |        |
|       | 3mm       | SN3-25x1M   |                      |       |       |          |             |                  | 62           |        |
|       | 0.125     | SN2-2516X   |                      |       |       |          |             |                  | 64           |        |
|       | 0.200     | SN4-2520X   |                      |       |       |          |             |                  | 72           |        |
|       | 0.250     | SN4-2516X   |                      |       |       |          |             |                  | 76           |        |
|       | 0.500     | SN7-2514X   |                      |       |       |          |             |                  | 81           |        |
|       | 0.750     | SN12-2516   |                      |       |       |          |             |                  | 82           |        |
|       | 0.750     | SN12-2516   |                      |       |       |          |             |                  | 82           |        |
| 5/16" | 0.083     | SN3112X     | 0.750                | 0.750 | 0.250 | 5/8-18   | 70 lbs      | 350 lbs          | 49           | F37    |
|       | 0.167     | SN2-3112X   |                      |       |       |          |             |                  | 65           |        |
|       | 0.250     | SN2-3108X   |                      |       |       |          |             |                  | 72           |        |
|       | 0.500     | SN4-3108X   |                      |       |       |          |             |                  | 80           |        |
|       | 1.000     | SN8-3108X   |                      |       |       |          |             |                  | 81           |        |
| 3/8"  | 0.050     | SN3720X     | 0.750                | 0.750 | 0.250 | 5/8-18   | 70 lbs      | 350 lbs          | 32           | F37    |
|       | 0.063     | SN3716X     |                      |       |       |          |             |                  | 36           |        |
|       | 2mm       | SN37x2M     |                      |       |       |          |             |                  | 42           |        |
|       | 0.083     | SN3712X     |                      |       |       |          |             |                  | 44           |        |
|       | 0.100     | SN3710X     |                      |       |       |          |             |                  | 49           |        |
|       | 0.125     | SN3708X     |                      |       |       |          |             |                  | 53           |        |
|       | 0.167     | SN2-3712X   |                      |       |       |          |             |                  | 60           |        |
|       | 0.200     | SN2-3710X   |                      |       |       |          |             |                  | 65           |        |
|       | 0.250     | SN2-3708X   |                      |       |       |          |             |                  | 68           |        |
|       | 0.300     | SN3-3710X   |                      |       |       |          |             |                  | 73           |        |
|       | 0.375     | SN4-3711X   |                      |       |       |          |             |                  | 75           |        |
|       | 0.500     | SN4-3708X   |                      |       |       |          |             |                  | 79           |        |
|       | 0.750     | SN6-3708    |                      |       |       |          |             |                  | 82           |        |
|       | 1.000     | SN5-3705X   |                      |       |       |          |             |                  | 82           |        |
| 1.200 | SN5-3704X | 82          |                      |       |       |          |             |                  |              |        |
| 10mm  | 2mm       | SN10x2M     | 0.750                | 0.750 | 0.250 | 5/8-18   | 70 lbs      | 350 lbs          | 41           | F37    |
|       | 3mm       | SN10x3M     |                      |       |       |          |             |                  | 53           |        |
|       | 4mm       | SN2-10x2M   |                      |       |       |          |             |                  | 59           |        |
|       | 5mm       | SN2-10x2.5M |                      |       |       |          |             |                  | 64           |        |
|       | 6mm       | SN4-10x1.5M |                      |       |       |          |             |                  | 67           |        |
|       | 10mm      | SN5-10x2M   |                      |       |       |          |             |                  | 76           |        |
|       | 12mm      | SN5-10x2.4M |                      |       |       |          |             |                  | 78           |        |
|       | 20mm      | SN6-10x3.3M |                      |       |       |          |             |                  | 67           |        |
| 7/16" | 0.125     | SN2-4316X   | 1.000                | 1.000 | 0.375 | 15/16-16 | 100 lbs     | 500 lbs          | 55           | F50    |
|       | 0.250     | SN2-4308X   |                      |       |       |          |             |                  | 65           |        |
|       | 0.500     | SN4-4308X   |                      |       |       |          |             |                  | 76           |        |

\* For all sizes shown on this page Drag Torque = Free Wheeling

## Thread Mount Supernuts®

SN

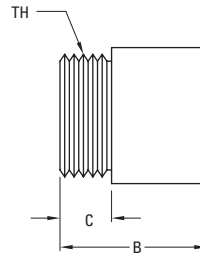
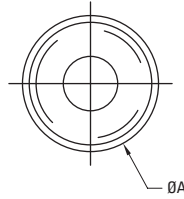
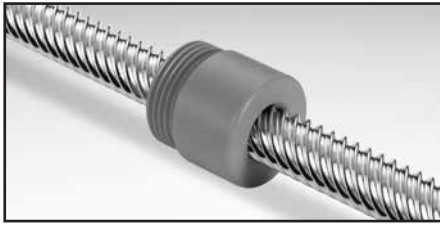

### Flanges

|               |       |
|---------------|-------|
| 3/16" to 1/4" | F25   |
| 5/16" to 10mm | F37   |
| 7/16" to 16mm | F50   |
| 3/4" to 1"    | F75   |
| 1-1/4"        | F100  |
| 1-1/2"        | R54-3 |

Dimensions available on page 35 or online.

SN

1/2" (12mm) to 5/8" (16mm) Diameter\*

| Dia.  | Lead       | Part No.     | Supernut® Dimensions |       |       |          | Design Load | Max. Static Load | Efficiency % | Flange |
|-------|------------|--------------|----------------------|-------|-------|----------|-------------|------------------|--------------|--------|
|       |            |              | A                    | B     | C     | TH       |             |                  |              |        |
| 12mm  | 3mm        | SN12x3M      | 1.000                | 1.000 | 0.375 | 15/16-16 | 100 lbs     | 500 lbs          | 48           | F50    |
|       | 4mm        | SN2-12x2M    |                      |       |       |          |             |                  | 54           |        |
|       | 5mm        | SN2-12x2.5M  |                      |       |       |          |             |                  | 59           |        |
|       | 6mm        | SN3-12x2M    |                      |       |       |          |             |                  | 63           |        |
|       | 10mm       | SN4-12x2.5M  |                      |       |       |          |             |                  | 73           |        |
|       | 15mm       | SN6-12x2.5M  |                      |       |       |          |             |                  | 78           |        |
|       | 25mm       | SN10-12x2.5M |                      |       |       |          |             |                  | 82           |        |
|       | 45mm       | SN15-12x3M   |                      |       |       |          |             |                  | 81           |        |
| 1/2"  | 0.0625     | SN5016X      | 1.000                | 1.000 | 0.375 | 15/16-16 | 150 lbs     | 750 lbs          | 30           | F50    |
|       | 0.100      | SN5010X      |                      |       |       |          |             |                  | 41           |        |
|       | 4mm        | SN2-50x2M    |                      |       |       |          |             |                  | 52           |        |
|       | 0.200      | SN2-5010X    |                      |       |       |          |             |                  | 57           |        |
|       | 0.250      | SN2-5008X    |                      |       |       |          |             |                  | 62           |        |
|       | 0.500      | SN4-5008X    |                      |       |       |          |             |                  | 75           |        |
|       | 0.800      | SN8-5010X    |                      |       |       |          |             |                  | 80           |        |
|       | 1.000      | SN8-5008X    |                      |       |       |          |             |                  | 81           |        |
| 1.500 | SN12-5008X | 82           |                      |       |       |          |             |                  |              |        |
| 5/8"  | 0.100      | SN6210X      | 1.000                | 1.000 | 0.375 | 15/16-16 | 160 lbs     | 800 lbs          | 35           | F50    |
|       | 0.125      | SN6208X      |                      |       |       |          |             |                  | 40           |        |
|       | 0.200      | SN2-6210X    |                      |       |       |          |             |                  | 51           |        |
|       | 0.250      | SN2-6208X    |                      |       |       |          |             |                  | 57           |        |
|       | 0.500      | SN4-6208X    |                      |       |       |          |             |                  | 71           |        |
| 16mm  | 4mm        | SN16x4M      | 1.000                | 1.000 | 0.375 | 15/16-16 | 160 lbs     | 800 lbs          | 47           | F50    |
|       | 5mm        | SN2-16x2.5M  |                      |       |       |          |             |                  | 52           |        |
|       | 8mm        | SN4-16x2M    |                      |       |       |          |             |                  | 63           |        |
|       | 16mm       | SN7-16x2.3M  |                      |       |       |          |             |                  | 75           |        |
|       | 25mm       | SN5-16x5M    |                      |       |       |          |             |                  | 80           |        |
|       | 35mm       | SN7-16x5M    |                      |       |       |          |             |                  | 82           |        |

\* For all sizes shown on this page Drag Torque = Free Wheeling

## Thread Mount Supernuts®

SN

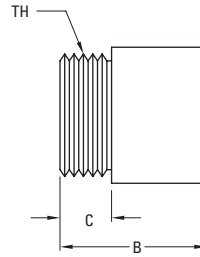
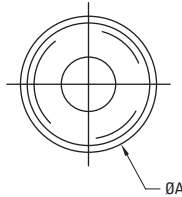
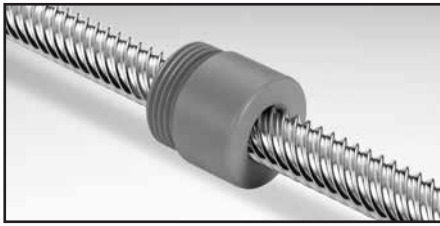

### Flanges

|               |       |
|---------------|-------|
| 3/16" to 1/4" | F25   |
| 5/16" to 10mm | F37   |
| 7/16" to 16mm | F50   |
| 3/4" to 1"    | F75   |
| 1-1/4"        | F100  |
| 1-1/2"        | R54-3 |

Dimensions available on page 35 or online.

SN

3/4" to 1 1/2" Diameter\*

| Dia.   | Lead  | Part No.   | Supernut® Dimensions |       |       |           | Design Load | Max. Static Load | Efficiency % | Flange |
|--------|-------|------------|----------------------|-------|-------|-----------|-------------|------------------|--------------|--------|
|        |       |            | A                    | B     | C     | TH        |             |                  |              |        |
| 3/4"   | 0.100 | SN7510X    | 1.500                | 1.500 | 0.500 | 1 3/8-16  | 300 lbs     | 1500 lbs         | 31           | F75    |
|        | 0.125 | SN7508X    |                      |       |       |           |             |                  | 36           |        |
|        | 0.167 | SN7506X    |                      |       |       |           |             |                  | 44           |        |
|        | 0.200 | SN7505X    |                      |       |       |           |             |                  | 49           |        |
|        | 0.500 | SN5-7510X  |                      |       |       |           |             |                  | 69           |        |
|        | 1.000 | SN8-7508X  |                      |       |       |           |             |                  | 79           |        |
|        | 1.500 | SN12-7508X |                      |       |       |           |             |                  | 81           |        |
|        | 2.000 | SN10-7505X |                      |       |       |           |             |                  | 82           |        |
| 20mm   | 4mm   | SN20x4M    | 1.500                | 1.500 | 0.500 | 1 3/8-16  | 300 lbs     | 1500 lbs         | 41           | F75    |
|        | 8mm   | SN2-20x4M  |                      |       |       |           |             |                  | 59           |        |
|        | 12mm  | SN3-20x4M  |                      |       |       |           |             |                  | 67           |        |
|        | 16mm  | SN4-20x4M  |                      |       |       |           |             |                  | 72           |        |
|        | 20mm  | SN5-20x4M  |                      |       |       |           |             |                  | 76           |        |
|        | 45mm  | SN9-20x5M  |                      |       |       |           |             |                  | 82           |        |
|        | 50mm  | SN10-20x5M |                      |       |       |           |             |                  | 82           |        |
| 24mm   | 5mm   | SN24x5M    | 1.500                | 1.500 | 0.500 | 1 3/8-16  | 300 lbs     | 1500 lbs         | 42           | F75    |
| 1"     | 0.100 | SN1010X    | 1.500                | 1.500 | 0.500 | 1 3/8-16  | 400 lbs     | 2000 lbs         | 25           | F75    |
|        | 0.125 | SN1008X    |                      |       |       |           |             |                  | 29           |        |
|        | 0.200 | SN1005X    |                      |       |       |           |             |                  | 41           |        |
|        | 0.250 | SN2-1008X  |                      |       |       |           |             |                  | 46           |        |
|        | 0.250 | SN1004X    |                      |       |       |           |             |                  | 47           |        |
|        | 0.500 | SN5-1010X  |                      |       |       |           |             |                  | 61           |        |
|        | 1.000 | SN10-1010X |                      |       |       |           |             |                  | 74           |        |
| 1 1/4" | 0.200 | SN1205X    | 2.000                | 2.000 | 0.600 | 1 9/16-18 | 400 lbs     | 2000 lbs         | 35           | F100   |
|        | 0.200 | SN2-1210X  |                      |       |       |           |             |                  | 35           |        |
|        | 0.250 | SN1204X    |                      |       |       |           |             |                  | 41           |        |
| 1 1/2" | 0.200 | SN1505X    | 2.000                | 2.500 | 0.530 | 1.967-18  | 400 lbs     | 2000 lbs         | 31           | R54-3  |
|        | 0.250 | SN1504X    |                      |       |       |           |             |                  | 36           |        |
|        | 0.375 | SN1503X    |                      |       |       |           |             |                  | 47           |        |
|        | 0.500 | SN2-1504X  |                      |       |       |           |             |                  | 52           |        |

\* For all sizes shown on this page Drag Torque = Free Wheeling

## Metric Thread Mount Supernuts®

SB

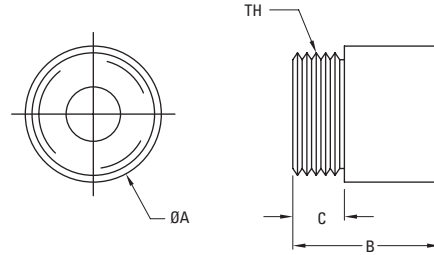
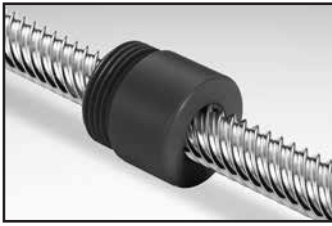

Our classic Supernut is now available with metric mounting thread. Offered with our metric screw line sizes 10mm through 24mm. The nut color is black to easily differentiate it from the SN nut (see p. 29)

SB  
10mm to 24mm) Diameter\*

| Dia. | Lead | Part No.     | Supernut® Dimensions |                 |                 |           | Design Load<br>lb (N) | Max. Static Load<br>lb (N) | Efficiency % |
|------|------|--------------|----------------------|-----------------|-----------------|-----------|-----------------------|----------------------------|--------------|
|      |      |              | A<br>in (mm)         | B<br>in (mm)    | C<br>in (mm)    | TH        |                       |                            |              |
| 10mm | 2mm  | SB10x2M      | 0.750<br>(19.1)      | 0.750<br>(19.1) | 0.250<br>(6.5)  | M16 x 1.5 | 70<br>(310)           | 350<br>(1550)              | 42           |
|      | 3mm  | SB10x3M      |                      |                 |                 |           |                       |                            | 53           |
|      | 4mm  | SB2-10x2M    |                      |                 |                 |           |                       |                            | 59           |
|      | 5mm  | SB2-10x2.5M  |                      |                 |                 |           |                       |                            | 64           |
|      | 6mm  | SB4-10x1.5M  |                      |                 |                 |           |                       |                            | 66           |
|      | 10mm | SB5-10x2M    |                      |                 |                 |           |                       |                            | 76           |
|      | 12mm | SB5-10x2.4M  |                      |                 |                 |           |                       |                            | 78           |
| 12mm | 20mm | SB6-10x3.3M  | 1.000<br>(25.4)      | 1.000<br>(25.4) | 0.375<br>(9.5)  | M22 x 1.5 | 100<br>(445)          | 500<br>(2225)              | 81           |
|      | 3mm  | SB12x3M      |                      |                 |                 |           |                       |                            | 48           |
|      | 4mm  | SB2-12x2M    |                      |                 |                 |           |                       |                            | 54           |
|      | 5mm  | SB2-12x2.5M  |                      |                 |                 |           |                       |                            | 59           |
|      | 6mm  | SB3-12x2M    |                      |                 |                 |           |                       |                            | 63           |
|      | 10mm | SB4-12x2.5M  |                      |                 |                 |           |                       |                            | 73           |
|      | 15mm | SB6-12x2.5M  |                      |                 |                 |           |                       |                            | 78           |
| 16mm | 25mm | SB10-12x2.5M | 1.000<br>(25.4)      | 1.000<br>(25.4) | 0.375<br>(9.5)  | M22 x 1.5 | 160<br>(710)          | 800<br>(3560)              | 82           |
|      | 45mm | SB15-12x3M   |                      |                 |                 |           |                       |                            | 81           |
|      | 4mm  | SB16x4M      |                      |                 |                 |           |                       |                            | 48           |
|      | 5mm  | SB2-16x2.5M  |                      |                 |                 |           |                       |                            | 52           |
|      | 8mm  | SB4-16x2M    |                      |                 |                 |           |                       |                            | 63           |
| 20mm | 16mm | SB7-16x2.3M  | 1.500<br>(38.1)      | 1.500<br>(38.1) | 0.500<br>(12.7) | M35 x 1.5 | 300<br>(1335)         | 1500<br>(6675)             | 75           |
|      | 25mm | SB5-16x5M    |                      |                 |                 |           |                       |                            | 80           |
|      | 35mm | SB7-16x5M    |                      |                 |                 |           |                       |                            | 82           |
|      | 4mm  | SB20x4M      |                      |                 |                 |           |                       |                            | 42           |
|      | 8mm  | SB2-20x4M    |                      |                 |                 |           |                       |                            | 59           |
|      | 12mm | SB3-20x4M    |                      |                 |                 |           |                       |                            | 67           |
|      | 16mm | SB4-20x4M    |                      |                 |                 |           |                       |                            | 72           |
| 24mm | 20mm | SB5-20x4M    | 1.500<br>(38.1)      | 1.500<br>(38.1) | 0.500<br>(12.7) | M35 x 1.5 | 300<br>(1335)         | 1500<br>(6675)             | 76           |
|      | 45mm | SB9-20x5M    |                      |                 |                 |           |                       |                            | 82           |
|      | 50mm | SB10-20x5M   |                      |                 |                 |           |                       |                            | 82           |
| 24mm | 5mm  | SB24x5M      | 1.500<br>(38.1)      | 1.500<br>(38.1) | 0.500<br>(12.7) | M35 x 1.5 | 300<br>(1335)         | 1500<br>(6675)             | 42           |

\* For all sizes shown on this page Drag Torque = Free Wheeling



## Thread Mount Bronze Nuts

For Acme Screws

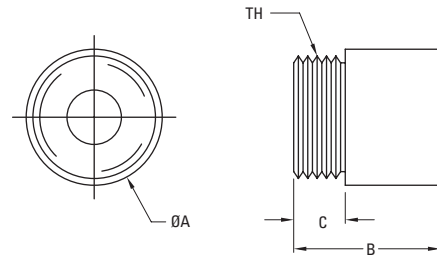

For standard bronze nuts, Thomson BSA uses SAE 660 bearing bronze which provides excellent load carrying ability, good wear resistance and is less susceptible to damage from impact and shock loading. Custom bronzes can be selected if required.

### Material Properties

| Maximum Temperature | Friction Coefficient | Material* | Tensile Strength |
|---------------------|----------------------|-----------|------------------|
| max. 250°F          | 0.2 to 0.3           | SAE 660   | 35,000 psi       |

\* Other materials available on a custom basis.

### 1/4" to 5/8" Diameter

| Dia. | Lead  | Nut Part No. for R.H. Screws | Nut Part No. for L.H. Screws | Bronze Nut Dimensions |       |       |          | Fits Flange No. | Design Load† | Maximum Static Load | Torque to Raise 1 Pound (in-oz) |
|------|-------|------------------------------|------------------------------|-----------------------|-------|-------|----------|-----------------|--------------|---------------------|---------------------------------|
|      |       |                              |                              | A                     | B     | C     | TH       |                 |              |                     |                                 |
| 1/4" | .050  | BN2520                       | BN2520L                      | 0.625                 | 0.625 | 0.187 | 9/16-18  | F25             | 110 lbs      | 550 lbs             | .41                             |
|      | .0625 | BN2516                       | —                            |                       |       |       |          |                 |              |                     | .43                             |
|      | .250  | BN4-2516                     | —                            |                       |       |       |          |                 |              |                     | 1.00                            |
| 3/8" | .0625 | BN3716                       | —                            | 0.750                 | 0.750 | 0.250 | 5/8-18   | F37             | 300 lbs      | 1,500 lbs           | .61                             |
|      | .083  | BN3712                       | BN3712L                      |                       |       |       |          |                 |              |                     | .64                             |
|      | .100  | BN3710                       | BN3710L                      |                       |       |       |          |                 |              |                     | .67                             |
|      | .125  | BN3708S                      | —                            |                       |       |       |          |                 |              |                     | .76                             |
|      | .167  | BN2-3712S                    | —                            |                       |       |       |          |                 |              |                     | .86                             |
| 1/2" | .100  | BN5010                       | BN5010L                      | 1.00                  | 1.00  | 0.375 | 15/16-16 | F50             | 620 lbs      | 3,100 lbs           | .83                             |
|      | .200  | BN2-5010                     | —                            |                       |       |       |          |                 |              |                     | 1.10                            |
| 5/8" | .100  | BN6210                       | BN6210L                      | 1.00                  | 1.00  | 0.375 | 15/16-16 | F50             | 860 lbs      | 4,300 lbs           | .99                             |
|      | .125  | BN6208S                      | —                            |                       |       |       |          |                 |              |                     | 1.06                            |
|      | .200  | BN2-6210                     | —                            |                       |       |       |          |                 |              |                     | 1.26                            |

† Load ratings based on using Thomson BSA grease. See page 233.

## Thread Mount Bronze Nuts

For Acme Screws

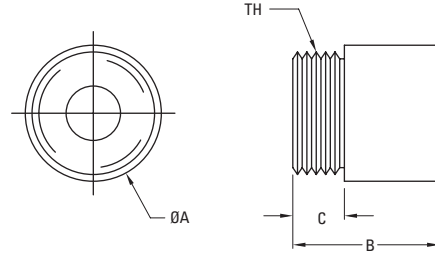

3/4" to 3" Diameter

| Dia.   | Lead  | Nut Part No. for R.H. Screws | Nut Part No. for L.H. Screws | Bronze Nut Dimensions |      |       |             | Fits Flange No. | Design Load† | Maximum Static Load | Torque to Raise 1 Pound (in-oz) |
|--------|-------|------------------------------|------------------------------|-----------------------|------|-------|-------------|-----------------|--------------|---------------------|---------------------------------|
|        |       |                              |                              | A                     | B    | C     | TH          |                 |              |                     |                                 |
| 3/4"   | .100  | BN7510                       | BN7510L                      | 1.50                  | 1.50 | 0.500 | 1-3/8 - 16  | F75             | 1,500 lbs    | 7,500 lbs           | 1.15                            |
|        | .125  | BN7508                       | —                            |                       |      |       |             |                 |              |                     | 1.21                            |
|        | .167  | BN7506                       | BN7506L                      |                       |      |       |             |                 |              |                     | 1.28                            |
|        | .200  | BN7505                       | BN7505L                      |                       |      |       |             |                 |              |                     | 1.35                            |
| 1"     | .100  | BN1010                       | —                            | 1.50                  | 1.50 | 0.500 | 1-3/8 - 16  | F75             | 1,900 lbs    | 9,500 lbs           | 1.47                            |
|        | .125  | BN1008                       | —                            |                       |      |       |             |                 |              |                     | 1.52                            |
|        | .200  | BN1005                       | —                            |                       |      |       |             |                 |              |                     | 1.67                            |
|        | .250  | BN1004                       | —                            |                       |      |       |             |                 |              |                     | 1.76                            |
|        | .500  | BN5-1010                     | —                            |                       |      |       |             |                 |              |                     | 2.55                            |
|        | 1.000 | BN10-1010                    | —                            |                       |      |       |             |                 |              |                     | 3.91                            |
| 1-1/4" | .200  | BN1205*                      | —                            | 1.75                  | 1.75 | 0.625 | 1-9/16 - 18 | R1004-3         | 3,000 lbs    | 15,000 lbs          | 1.99                            |
|        | .250  | BN1204*                      | —                            |                       |      |       |             |                 |              |                     | 2.09                            |
| 1-1/2" | .200  | BN1505*                      | —                            | 2.25                  | 2.25 | 0.530 | 1.967-18    | R54-3           | 4,600 lbs    | 23,000 lbs          | 2.31                            |
|        | .250  | BN1504*                      | —                            |                       |      |       |             |                 |              |                     | 2.41                            |
|        | .375  | BN1503*                      | —                            |                       |      |       |             |                 |              |                     | 2.56                            |
|        | .500  | BN2-1504*                    | —                            |                       |      |       |             |                 |              |                     | 3.08                            |
| 2"     | .250  | BN2004*                      | —                            | 2.75                  | 3.50 | 0.780 | 2.548-18    | R50-3           | 8,000 lbs    | 40,000 lbs          | 3.04                            |
| 2-1/4" | .250  | BN2204*                      | —                            | 3.37                  | 3.00 | 1.56  | 3.137-12    | R2202-3         | 12,800 lbs   | 64,000 lbs          | 3.70                            |
| 2-1/2" | .250  | BN2504*                      | —                            | 3.37                  | 3.00 | 1.56  | 3.137-12    | R2202-3         | 16,000 lbs   | 80,000 lbs          | 3.90                            |
| 2-3/4" | .250  | BN2704*                      | —                            | 4.00                  | 4.00 | 1.75  | 3.625-12    | R2501-3         | 20,000 lbs   | 100,000 lbs         | 4.20                            |
| 3"     | .250  | BN3004*                      | —                            | 4.00                  | 4.00 | 1.75  | 3.625-12    | R2501-3         | 23,000 lbs   | 115,000 lbs         | 4.50                            |

† Load ratings based on using Thomson BSA grease. See page 233.

\* Non-stock item

## Standard Mounting Flanges

For Bronze Nuts and Supernuts®

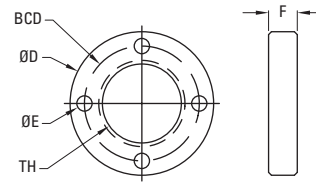

These mounting flanges are designed for easy mounting when fixed to a bronze nut or Supernut®.

Aluminum (6061-T6) Flanges for Bronze Nuts and Supernuts®

| Part No. | Flange Dimensions |            |       |      |             |
|----------|-------------------|------------|-------|------|-------------|
|          | D                 | E          | F     | BCD  | TH          |
| F25      | 1.25              | 0.140 (4X) | 0.187 | 1.00 | 9/16 - 18   |
| F37      | 1.60              | 0.177 (4X) | 0.250 | 1.24 | 5/8 - 18    |
| F50      | 2.00              | 0.266 (4X) | 0.375 | 1.50 | 15/16 - 16  |
| F75      | 2.50              | 0.266 (4X) | 0.500 | 2.00 | 1-3/8 - 16  |
| F100     | 3.00              | 0.266 (4X) | 0.600 | 2.37 | 1-9/16 - 18 |

Aluminum flanges do not have a set screw which could deform the Supernut® and possibly cause binding. Aluminum flanges should be pinned or bonded to Supernuts® to prevent unwanted disassembly during operation.

## Lead Screws

Lead Screws — 3/16" to 3/8" Diameter



| Nominal Major Diameter | Lead   | Precision Prefix | Standard Prefix | BSA Part No. | Avail in Left Hand | Material        | Root Diameter | Recommended Bearing |
|------------------------|--------|------------------|-----------------|--------------|--------------------|-----------------|---------------|---------------------|
| 3/16"                  | 0.050  | SPR              | SRA             | 1820         | L                  | Stainless Steel | 0.12          | N/A                 |
|                        | 0.100  |                  |                 | 2-1820       |                    |                 | 0.12          |                     |
|                        | 0.125  |                  |                 | 3-1824       |                    |                 | 0.13          |                     |
|                        | 0.200  |                  |                 | 4-1820       |                    |                 | 0.12          |                     |
|                        | 0.375  | N/A              |                 | 8-1821       |                    |                 | 0.13          |                     |
|                        | 0.400  |                  |                 | 8-1820       |                    |                 | 0.13          |                     |
|                        | 0.500  |                  |                 | 10-1820      |                    |                 | 0.13          |                     |
| 6mm                    | 1mm    | SPR              | SRA             | 6x1M         | L                  | Stainless Steel | 0.18          | 4mm                 |
| 1/4"                   | 0.031  | SPR              | SRA             | 2532         | L                  | Stainless Steel | 0.21          | 4mm                 |
|                        | 0.050  |                  |                 | 2520         | L                  |                 | 0.19          |                     |
|                        | 0.063  |                  |                 | 2516         | L                  |                 | 0.17          |                     |
|                        | 2mm    |                  |                 | 2-25x1M      |                    |                 | 0.19          |                     |
|                        | 3mm    |                  |                 | 3-25x1M      |                    |                 | 0.19          |                     |
|                        | 0.125  |                  |                 | 2-2516       |                    |                 | 0.17          |                     |
|                        | 0.200  |                  |                 | 4-2520       |                    |                 | 0.18          |                     |
|                        | 0.250  | 4-2516           |                 |              | 0.17               |                 |               |                     |
|                        | 0.500  | N/A              |                 | 7-2514       |                    |                 | 0.16          |                     |
|                        | 0.750  |                  |                 | 12-2516      |                    |                 | 0.18          |                     |
| 0.083                  | SPR    |                  | SRA             | 3112         | L                  | Stainless Steel | 0.22          | 4mm                 |
| 0.167                  |        | 2-3112           |                 |              | 0.20               |                 |               |                     |
| 0.250                  |        | 2-3108S          |                 |              | 0.22               |                 |               |                     |
| 0.500                  |        | 4-3108S          |                 |              | 0.21               |                 |               |                     |
| 1.000                  |        | 8-3108           |                 |              | 0.23               |                 |               |                     |
| 3/8"                   | 0.0500 | SPR              | SRA             | 3720         | L                  | Stainless Steel | 0.30          | 4mm                 |
|                        | 0.0625 |                  |                 | 3716         | L                  |                 | 0.30          |                     |
|                        | 2mm    |                  |                 | 37x2M        | L                  |                 | 0.28          |                     |
|                        | 0.083  |                  |                 | 3712         | L                  |                 | 0.28          |                     |
|                        | 0.100  |                  |                 | 3710         | L                  |                 | 0.26          |                     |
|                        | 0.125  |                  |                 | 3708S        | L                  |                 | 0.29          |                     |
|                        | 0.167  |                  |                 | 2-3712S      |                    |                 | 0.31          |                     |
|                        | 0.200  |                  |                 | 2-3710       |                    |                 | 0.26          |                     |
|                        | 0.250  |                  |                 | 2-3708S      | L                  |                 | 0.29          |                     |
|                        | 0.300  |                  |                 | 3-3710       |                    |                 | 0.25          |                     |
|                        | 0.375  |                  |                 | 4-3711       | L                  |                 | 0.27          |                     |
|                        | 0.500  | 4-3708S          |                 | L            | 0.27               |                 |               |                     |
|                        | 0.750  | N/A              |                 | 6-3708       |                    |                 | 0.27          |                     |
|                        | 1.00   |                  |                 | 5-3705       |                    |                 | 0.24          |                     |
|                        | 1.20   |                  |                 | 5-3704       |                    |                 | 0.24          |                     |

## Lead Screws

Lead Screws — 7/16" (10mm) to 5/8" (16mm) Diameter

| Nominal Major Diameter | Lead   | Precision Prefix | Standard Prefix | BSA Part No. | Avail in Left Hand | Material        | Root Diameter | Recommended Bearing |
|------------------------|--------|------------------|-----------------|--------------|--------------------|-----------------|---------------|---------------------|
| 10mm                   | 2mm    | SPT              | SRT             | 10x2M        | L                  | Stainless Steel | 0.31          | 4mm                 |
|                        | 3mm    |                  |                 | 10x3M        | L                  |                 | 0.25          |                     |
|                        | 4mm    |                  |                 | 2-10x2M      |                    |                 | 0.29          |                     |
|                        | 5mm    | SPR              | SRA             | 2-10x2.5M    |                    |                 | 0.27          |                     |
|                        | 6mm    |                  |                 | 4-10x1.5M    |                    |                 | 0.31          |                     |
|                        | 10mm   |                  |                 | 5-10x2M      |                    |                 | 0.29          |                     |
|                        | 12mm   |                  |                 | 5-10x2.4M    |                    |                 | 0.29          |                     |
|                        | 20mm   |                  |                 | 6-10x3.3M    |                    |                 | 0.30          |                     |
| 7/16"                  | 0.125  | SPR              | SRA             | 2-4316       |                    | Stainless Steel | 0.35          | 6mm                 |
|                        | 0.250  |                  |                 | 2-4308S      |                    |                 | 0.36          |                     |
|                        | 0.500  |                  |                 | 4-4308S      |                    |                 | 0.33          |                     |
| 12mm                   | 3mm    | SPT              | SRT             | 12x3M        |                    | Stainless Steel | 0.31          | 6mm                 |
|                        | 4mm    | SPR              | SRA             | 2-12x2M      |                    |                 | 0.36          |                     |
|                        | 5mm    | SPT              | SRT             | 2-12x2.5M    |                    |                 | 0.35          |                     |
|                        | 6mm    | SPR              | SRA             | 3-12x2M      |                    |                 | 0.35          |                     |
|                        | 10mm   | SPT              | SRT             | 4-12x2.5M    |                    |                 | 0.35          |                     |
|                        | 15mm   | SPR              | SRA             | 6-12x2.5M    |                    |                 | 0.34          |                     |
|                        | 25mm   | N/A              | SRA             | 10-12x2.5M   |                    |                 | 0.36          |                     |
|                        | 45mm   |                  | SRA             | 15-12x3M     |                    |                 | 0.37          |                     |
| 1/2"                   | 0.0625 | SPR              | SRA             | 5016         |                    | Stainless Steel | 0.41          | 6mm                 |
|                        | 0.100  |                  |                 | 5010         | L                  |                 | 0.37          |                     |
|                        | 4mm    |                  |                 | 2-50x2M      |                    |                 | 0.39          |                     |
|                        | 0.200  |                  |                 | 2-5010       |                    |                 | 0.39          |                     |
|                        | 0.250  |                  |                 | 2-5008       |                    |                 | 0.38          |                     |
|                        | 0.500  | 4-5008           |                 |              | 0.36               |                 |               |                     |
|                        | 0.800  | N/A              |                 | 8-5010       |                    |                 | 0.37          |                     |
|                        | 1.000  |                  |                 | 8-5008       |                    |                 | 0.39          |                     |
|                        | 1.500  |                  |                 | 12-5008      |                    |                 | 0.39          |                     |
|                        |        |                  |                 |              |                    |                 |               |                     |
| 5/8"                   | 0.100  | SPR              | SRA             | 6210         | L                  | Stainless Steel | 0.52          | 8 to 10mm           |
|                        | 0.125  |                  |                 | 6208S        | L                  |                 | 0.52          |                     |
|                        | 0.200  |                  |                 | 2-6210       | L                  |                 | 0.52          |                     |
|                        | 0.250  |                  |                 | 2-6208S      |                    |                 | 0.52          |                     |
|                        | 0.500  |                  |                 | 4-6208       |                    |                 | 0.48          |                     |
| 16mm                   | 4mm    | SPT              | SRT             | 16x4M        | L                  | Stainless Steel | 0.45          | 8 to 10mm           |
|                        | 5mm    | SPR              | SRA             | 2-16x2.5M    |                    |                 | 0.48          |                     |
|                        | 8mm    |                  |                 | 4-16x2M      |                    |                 | 0.51          |                     |
|                        | 16mm   |                  |                 | 7-16x2.3M    |                    |                 | 0.49          |                     |
|                        | 25mm   | N/A              |                 | 5-16x5M      |                    |                 | 0.45          |                     |
|                        | 35mm   |                  |                 | 7-16x5M      |                    |                 | 0.48          |                     |

## Lead Screws

### Lead Screws — 3/4" (24mm) to 3" Diameter

| Nominal Major Diameter | Lead  | Precision Prefix | Standard Prefix | BSA Part No. | Avail in Left Hand | Material         | Root Diameter   | Recommended Bearing |
|------------------------|-------|------------------|-----------------|--------------|--------------------|------------------|-----------------|---------------------|
| 3/4"                   | 0.100 | SPR              | SRA             | 7510         | L                  | Stainless Steel  | 0.63            | 12mm                |
|                        | 0.125 |                  |                 | 7508         | L                  |                  | 0.61            |                     |
|                        | 0.167 |                  |                 | 7506         | L                  |                  | 0.56            |                     |
|                        | 0.200 |                  |                 | 7505         | L                  |                  | 0.53            |                     |
|                        | 0.500 | N/A              |                 | 5-7510       |                    |                  | 0.62            |                     |
|                        | 1.000 |                  |                 | 8-7508       |                    |                  | 0.61            |                     |
|                        | 1.500 |                  |                 | 12-7508      |                    |                  | 0.62            |                     |
|                        | 2.000 |                  |                 | 10-7505†     | L                  |                  | 0.59            |                     |
|                        |       |                  |                 |              |                    |                  |                 |                     |
| 20mm                   | 4mm   | SPT              | SRT             | 20x4M        | L                  | Stainless Steel  | 0.61            | 12mm                |
|                        | 8mm   | SPR              | SRA             | 2-20x4M      |                    |                  | 0.58            |                     |
|                        | 12mm  |                  |                 | 3-20x4M      |                    |                  | 0.59            |                     |
|                        | 16mm  |                  |                 | 4-20x4M      |                    |                  | 0.59            |                     |
|                        | 20mm  | –                |                 | 5-20x4M      |                    |                  | 0.59            |                     |
|                        | 45mm  | –                |                 | 9-20x5M      |                    |                  | 0.62            |                     |
|                        | 50mm  |                  |                 | 10-20x5M     |                    |                  | 0.65            |                     |
| 24mm                   | 5mm   | SPT              |                 | SRT          | 24x5M              | L                | Stainless Steel | 0.73                |
| 1"                     | 0.100 | SPR              | SRA             | 1010         | L                  | Stainless Steel  | 0.88            | 12 to 20mm          |
|                        | 0.125 |                  |                 | 1008         | L                  |                  | 0.86            |                     |
|                        | 0.200 |                  |                 | 1005         | L                  |                  | 0.78            |                     |
|                        | 0.250 | N/A              | RA              | 1004         | L                  | Carbon Steel     | 0.72            | 12 to 15mm          |
|                        | 0.250 | SPR              | SRA             | 2-1008       |                    | Stainless Steel  | 0.84            | 12 to 20mm          |
|                        | 0.500 | N/A              |                 | 5-1010       |                    |                  | 0.88            |                     |
|                        | 1.000 |                  |                 | 10-1010      |                    |                  | 0.88            |                     |
|                        |       |                  |                 |              |                    |                  |                 |                     |
| 1-1/4"                 | 0.200 | N/A              | RA              | 1205         | L                  | Low Carbon Steel | 1.03            | 20mm                |
|                        | 0.200 |                  | SRA             | 1205         | L                  | Stainless Steel  | 1.01            |                     |
|                        | 0.200 |                  |                 | 2-1210       |                    |                  | 1.11            |                     |
|                        | 0.250 |                  | RA              | 1204         | L                  | Low Carbon Steel | 0.98            |                     |
| 1-1/2"                 | 0.200 | N/A              | RA              | 1505         | L                  | Low Carbon Steel | 1.28            | 25mm                |
|                        | 0.250 |                  |                 | 1504         | L                  |                  | 1.23            |                     |
|                        | 0.375 |                  |                 | 1503         |                    |                  | 1.11            |                     |
|                        | 0.500 |                  |                 | 2-1504       |                    |                  | 1.23            |                     |
| 2"                     | 0.250 | N/A              | RA              | 2004         | L                  | Low Carbon Steel | 1.73            | *                   |
| 2-1/4"                 | 0.250 | N/A              | RA              | 2204         | L                  | Low Carbon Steel | 1.98            | *                   |
| 2-1/2"                 | 0.250 | N/A              | RA              | 2504         | L                  | Low Carbon Steel | 2.23            | *                   |
| 2-3/4"                 | 0.250 | N/A              | RA              | 2704         | L                  | Low Carbon Steel | 2.48            | *                   |
| 3"                     | 0.250 | N/A              | RA              | 3004         | L                  | Low Carbon Steel | 2.73            | *                   |

† Nominal O.D. is .734"

## V-Thread Screws

Burnished Finish 303 Stainless Steel

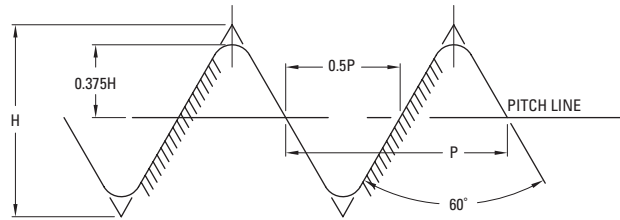
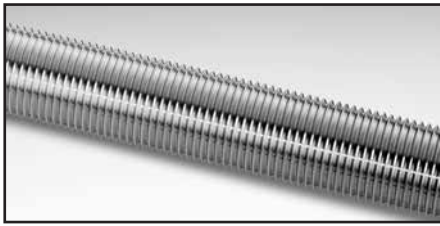

- Some sizes available in 1018 Steel
- Matching Supernuts and Left Hand Screws on special request
- Lead Accuracy is .015 in/ft

| Diameter | Lead   | Size    | Part No. | Recommended Bearing |
|----------|--------|---------|----------|---------------------|
| 6mm      | 1mm    | 6 x 1   | SV6x1    | 4mm                 |
| 1/4"     | 0.0125 | 1/4-80  | SV2580   | 4mm                 |
|          | 0.0208 | 1/4-48  | SV2548   |                     |
|          | 0.0250 | 1/4-40  | SV2540   |                     |
|          | 0.0278 | 1/4-36  | SV2536   |                     |
|          | 0.0313 | 1/4-32  | SV2532   |                     |
|          | 0.0357 | 1/4-28  | SV2528   |                     |
|          | 0.0417 | 1/4-24  | SV2524   |                     |
|          | 0.0500 | 1/4-20  | SV2520   |                     |
| 5/16"    | 0.0130 | 5/16-80 | SV3180   | 4mm                 |
|          | 0.0420 | 5/16-24 | SV3124   |                     |
| 3/8"     | 0.013  | 3/8-80  | SV3780   | 4 to 6mm            |
|          | 0.0250 | 3/8-40  | SV3740   |                     |
|          | 0.0313 | 3/8-32  | SV3732   |                     |
|          | 0.0400 | 3/8-25  | SV3725   |                     |
|          | 0.0417 | 3/8-24  | SV3724   |                     |
|          | 0.0500 | 3/8-20  | SV3720   |                     |
|          | 0.0625 | 3/8-16  | SV3716   |                     |
|          | 0.0833 | 3/8-12  | SV3712   |                     |
| 7/16"    | 0.0500 | 7/16-20 | SV4320   | 6mm                 |
| 1/2"     | 0.0130 | 1/2-80  | SV5080   | 6 to 8mm            |
|          | 0.0250 | 1/2-40  | SV5040   |                     |
|          | 0.0333 | 1/2-30  | SV5030   |                     |
|          | 0.0500 | 1/2-20  | SV5020   |                     |
|          | 0.0625 | 1/2-16  | SV5016   |                     |
|          | 0.0769 | 1/2-13  | SV5013   |                     |

**NOTES:**

A large grid area for taking notes, consisting of a 30x30 grid of small squares. The grid is empty and occupies the majority of the page below the 'NOTES:' header.



# Ball Screws — Inch Series



## Table of Contents

| <b>Description</b>   | <b>Page</b> |
|--|-------------|
| Product Overview .....   | 42          |
| Precision Rolled Ball Screws — Inch Series.....                                | 46          |
| Visual Product Reference — Precision Rolled<br>Ball Screws — Inch Series ..... | 91          |
| Precision Plus Ball Screws — Inch Series .....                                 | 101         |

Need a quote or have a question about an application?  
Contact us in North America at:

Phone: 540-633-3549

Fax: 540-639-4162

Email: [thomson@thomsonlinear.com](mailto:thomson@thomsonlinear.com)

## Ball Screws Product Overview

### Thomson Advantages

Ball screws are not all alike. Differences in design, quality, materials, manufacturing, and application support are all factors that affect the performance and extend the life of your ball screw. That's why it's important to select your ball screw — and ball screw supplier — very carefully.

#### **Design: Optimal solution for your application needs**

The Thomson engineering team has painstakingly evaluated the breadth of ball screw products from BSA, Warner Linear, and Thomson Industries and integrated them into a single, comprehensive, product offering. Our new line of ball screws come in a full range of diameters, leads, and ball nut configurations, in either preloaded or non-preloaded types, all in industry-standard envelopes. They provide dependable accuracy and repeatability at an economical price.

#### **Quality: Reliability and consistent performance**

At Thomson, we pride ourselves in consistently providing high quality ball screws. Our background in flight critical aerospace and defense applications uniquely positions us to provide the highest levels of quality across all our ball screw products. Our fully equipped engineering laboratory performs qualification testing for mechanical performance, environmental effects, and structural integrity. Your ball screw is inspected every step of the way to ensure top quality and performance. The result, Thomson ball screws perform the way you expect them to perform — no surprises, no problems.

#### **Materials: Just the right custom and standard offerings**

The materials used to manufacture ball screws are critical to their performance. Our in-house metallurgists control and verify that the materials used are of the highest quality. They can also select and recommend materials best suited to your particular application. We have years of experience working with a wide range of standard and non-standard materials. Put our experience and expertise to work for you!

#### **Manufacturing: Ensures consistent quality and delivery**

Thomson maintains the most modern and complete ball screw manufacturing facilities in the industry. In-house manufacturing capabilities include our proprietary heat treating and plating processes. Expert manufacturing using the most modern equipment available provides ball screws that set the standards for performance, precision, and travel life.

#### **Application Support: Over 70 years of experience at your disposal**

Working with Thomson is like having your own staff of ball screw design engineers able to address application concerns and recommend solutions. Thomson field sales and applications engineering personnel have more ball screw expertise than any other group in the industry. They are skilled at evaluating your requirements and designing assemblies that fit your needs.



**Catalog Standard  
Ball Screws feature  
a high luster polished  
and oiled finish.**

## Inch Ball Screws Product Overview

### Precision Rolled Screws — Product Availability<sup>(1)</sup>, Accuracy and Axial Play

| Screw Diameter   | Accuracy     | Max. Axial Backlash (Non-preloaded) <sup>(2)</sup> |
|------------------|--------------|--|
| 0.187" to 4.000" | ± .004 in/ft | 0.002 to 0.015"                                    |

|            | Inch  | Lead (in.) |       |       |       |       |       |       |       |       |       |       |       |       |
|------------|-------|------------|-------|-------|-------|-------|-------|-------|-------|-------|-------|-------|-------|-------|
|            |       | 0.050      | 0.062 | 0.125 | 0.200 | 0.250 | 0.413 | 0.473 | 0.500 | 0.660 | 1.000 | 1.500 | 1.875 | 2.000 |
| Dia. (in.) | 0.187 | ●          | ●     |       |       |       |       |       |       |       |       |       |       |       |
|            | 0.375 |            |       | ●     |       |       |       |       |       |       |       |       |       |       |
|            | 0.500 |            |       |       | ●     |       |       |       | ●     |       |       |       |       |       |
|            | 0.631 |            |       |       | ●     |       |       |       |       |       | ●     |       |       |       |
|            | 0.750 |            |       |       | ●     |       |       |       | ●     |       |       |       |       |       |
|            | 0.875 |            |       |       | ●     |       |       |       |       |       |       |       |       |       |
|            | 1.000 |            |       |       |       | ●     |       |       | ●     |       | ●     |       |       |       |
|            | 1.150 |            |       |       | ●     |       |       |       |       |       |       |       |       |       |
|            | 1.171 |            |       |       |       |       | ●     |       |       |       |       |       |       |       |
|            | 1.500 |            |       |       |       | ●     |       | ●     | ●     |       | ●     |       | ●     | ●     |
|            | 2.000 |            |       |       |       |       |       |       | ●     |       | ●     |       |       |       |
|            | 2.250 |            |       |       |       |       |       |       | ●     |       | ●     |       |       |       |
|            | 2.500 |            |       |       |       |       | ●     |       | ●     |       | ●     |       |       |       |
|            | 3.000 |            |       |       |       |       |       |       |       | ●     |       | ●     |       |       |
|            | 4.000 |            |       |       |       |       |       |       |       |       | ●     |       |       |       |

### Precision Plus Screws — Product Availability<sup>(1)</sup>, Accuracy and Axial Play

| Screw Diameter   | Accuracy      | Max. Axial Backlash |
|------------------|---------------|---------------------|
| 0.500" to 2.500" | ± .0005 in/ft | 0"                  |

|            | Inch  | Lead (in.) |       |       |       |       |       |       |       |       |       |       |       |       |
|------------|-------|------------|-------|-------|-------|-------|-------|-------|-------|-------|-------|-------|-------|-------|
|            |       | 0.050      | 0.062 | 0.125 | 0.200 | 0.250 | 0.413 | 0.473 | 0.500 | 0.660 | 1.000 | 1.500 | 1.875 | 2.000 |
| Dia. (in.) | 0.631 |            |       |       | ●     |       |       |       |       |       |       |       |       |       |
|            | 0.750 |            |       |       | ●     |       |       |       |       |       |       |       |       |       |
|            | 0.875 |            |       |       | ●     |       |       |       |       |       |       |       |       |       |
|            | 1.000 |            |       |       | ●     | ●     |       |       |       |       |       |       |       |       |
|            | 1.150 |            |       |       | ●     |       |       |       |       |       |       |       |       |       |
|            | 1.250 |            |       |       | ●     |       |       |       | ●     |       |       |       |       |       |
|            | 1.500 |            |       |       | ●     | ●     |       |       | ●     |       |       |       |       |       |
|            | 1.750 |            |       |       | ●     |       |       |       |       |       |       |       |       |       |
|            | 2.000 |            |       |       | ●     |       |       |       |       |       |       |       |       |       |
|            | 2.250 |            |       |       |       |       |       |       | ●     |       |       |       |       |       |
|            | 2.500 |            |       |       |       |       | ●     |       |       |       |       |       |       |       |

(1) Additional sizes are available. See our comprehensive product reference section on page 91, or contact customer service for more details.

(2) Standard lash dependent on ball diameter. See page 227 as reference. Consult factory for special requirements.

## Precision Rolled Ball Screws Product Overview — Inch Series

### Standard Non-Preloaded Ball Nuts

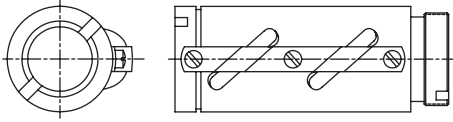

Standard Non-Preloaded Ball Nuts are a flexible, economical solution for use in industrial, transport grade applications. Both round and square models are available, with flange and wiper kits as accessories. Non-Preloaded Ball Nuts come standard with black-oxide coating (thin dense chrome is available upon request).

### Preloaded Ball Nuts

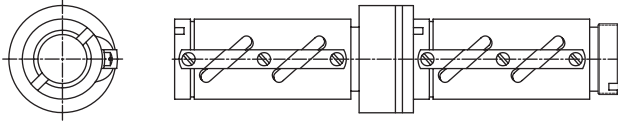

Preloaded Ball Nuts should be considered to eliminate backlash and increase system stiffness in applications where multi-directional positional accuracy and repeatability are required. Preloaded Ball Nuts consist of two non-preloaded ball nuts (round or square) joined by an adjustable preload package with springs. This design allows ease of setup and adjust of preload based on application requirements.

### Preloaded Ball Nuts with Integral Flange

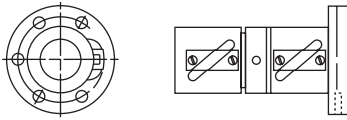

Preloaded Ball Nuts with Integral Flange provide higher-level positional accuracy and repeatability from a rolled screw assembly. These adjustable preload ball nuts feature precision ground internal threads, which enable smoother running, more consistent performance. The integral flange is held to high perpendicularity tolerances to ensure the load bearings are aligned to load to prevent unnecessary wear.

### Internal Return Ball Nuts

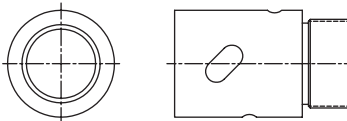

Internal Return Ball Nuts feature an internal ball recirculation system, which allows higher speeds, and lower noise in a compact envelope. Each nut includes an integrated wiper as standard. These ball nuts come standard "as machined" with corrosion protective film applied prior to shipment. Please note, a full line of internal return ball nuts are featured as part of our metric series ball screws.

### Cylindrical Ball Nuts

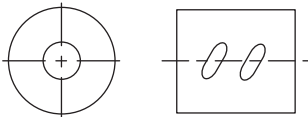

Cylindrical Ball Nuts are compact in size and ideal for constrained envelopes. These ball nuts come standard "as machined" with corrosion protective film applied prior to shipment. Please note, a full line of cylindrical ball nuts are featured as part of our metric series ball screws.

### High Capacity Ball Nuts

High Capacity Ball Nuts provide higher static and dynamic load capacities than our standard nuts. These ball nuts are typically longer than standard nuts, allowing for more balls in contact with the screw. High capacity nuts may also include larger balls than those found in standard ball nuts.

### High Speed Ball Nuts

High Speed Ball Nuts are designed to permit higher linear speeds in applications where critical speed of the ball nut (DN value) limits performance in an application. These ball nuts feature solid deflectors and reinforced ball return guides to allow smooth, reliable transition of balls entering and exiting the return system at high speeds.

## Precision Rolled Ball Screws Product Overview — Inch Series

### Tangential Ball Return

A unique Thomson feature which minimizes recirculated bearing ball deflection, for smoother and quieter operation. The tangential circuit consists of a pick-up deflector finger and modified return tube which allows the bearing balls to enter and exit the load carrying portion of the ball screw circuit in a straight path. Standard on ball bearing screws with up to 10,000 pound dynamic load capabilities.

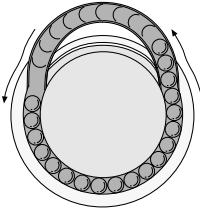

### Load Locking Spring

The load locking spring is a coil turned into the inactive portion of the nut and conforms to the ball tract. In normal operation, the spring is inactive and not in contact with the screw. In the event the ball bearings are lost from the nut, the load locking spring will not allow the load carrying nut to free-fall down the screw.

### End Journals and Bearing Supports

To assist the designer, standard end journals and bearing supports are included in this catalog. Ball screw assemblies, complete with end journals and bearing supports, may be ordered through a local Thomson distributor or directly from the factory.

Thomson welcomes the opportunity to custom machine end journals to unique customer designs.

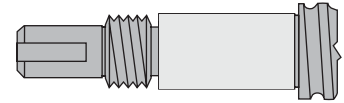

### Lube Holes

A standard 1/8-27 NPT tapped hole on ball nuts with a dynamic load capacity of 10,000 pounds or more provides easy access for continuing lubrication.

### Coating

Our catalog standard ball screws feature a high luster polished and oiled finish, which provides superior surface finish, smoother operation, and a high quality look and feel which is consistent across our entire product line. Additional ball screw coatings (thin dense chrome, black oxide, manganese phosphate) are available upon request.

### Wiper Kit

Wipers can increase the life and long-term performance of ball bearing screws by preventing most dirt and other foreign matter from entering the ball nut. Wipers are attached via two methods: Type A attaches directly to the ball nut body and flange; and Type B installs into the ends of the ball nut with easy-to-install snap rings kits. See our installation section on page 217 for more details.

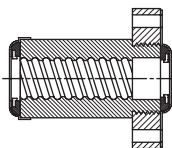

Type A

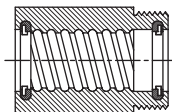

Type B

### Flanges

Standard flanges are offered for all ball nuts. Flanges provide an easy, low cost method to mount the load square and concentric to the ball screw.

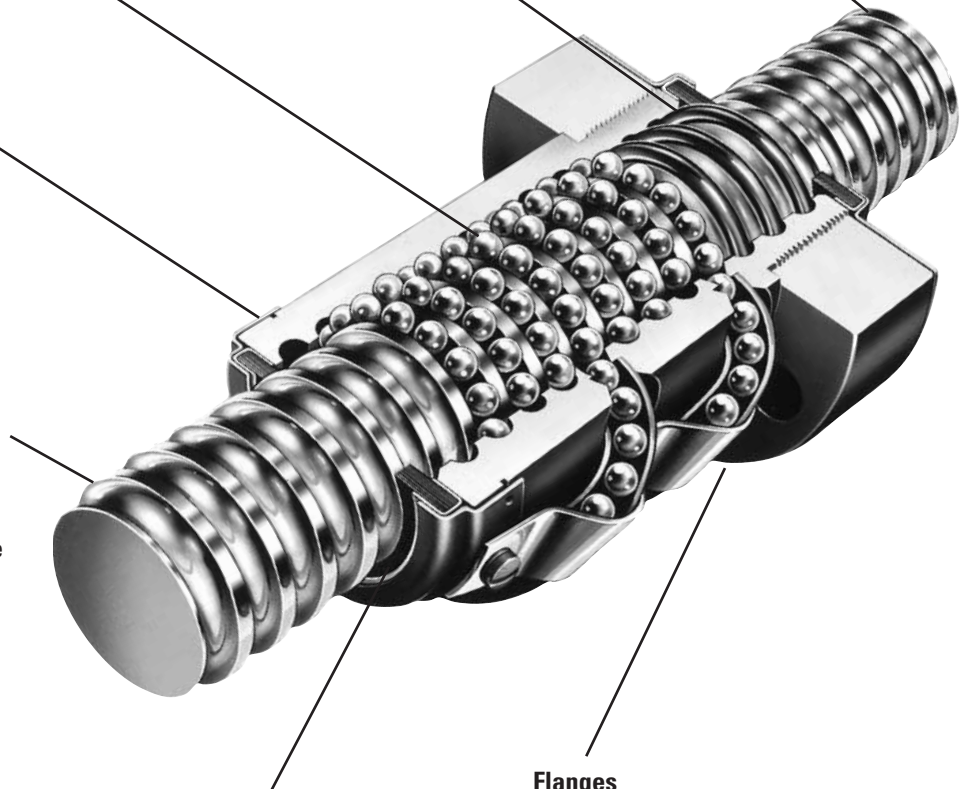

**0.187 x 0.050**

**Precision Rolled Ball Screws — Inch Series**

|                             |               |
|-----------------------------|---------------|
| Diameter x Lead (in.)       | 0.187 x 0.050 |
| Lead Accuracy (in/ft)       | ± 0.004       |
| Screw Weight (lbs/ft)       | 0.1           |
| Screw Root Diameter (in.)   | 0.14          |
| Nominal Ball Diameter (in.) | 0.039         |
| Number of Starts            | 1             |

**Double Circuit, Cylindrical Ball Nut, Internal Return — Stainless Steel**

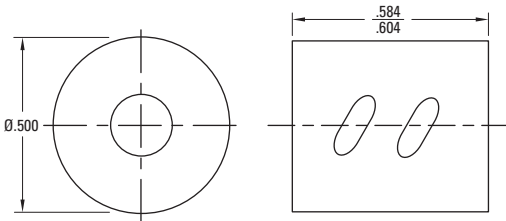

**Ball Screw Part Numbers**

|                  |             |             |                 |
|------------------|-------------|-------------|-----------------|
| Thread Direction | Right Hand  | Left Hand   | Right Hand      |
| Screw Material   | Alloy Steel | Alloy Steel | Stainless Steel |
| Standard Length  |             |             | 12"             |
| Maximum Length   |             |             | 12"             |
| Part Number      |             |             | <b>7821634</b>  |

Ball screws can be cut to the length you require. Specify ball screw part number and overall length at time of order.

|                               |             |             |                 |
|-------------------------------|-------------|-------------|-----------------|
| Thread Direction              | Right Hand  | Left Hand   | Right Hand      |
| Nut Material                  | Alloy Steel | Alloy Steel | Stainless Steel |
| Dynamic Load (lbs)            |             |             | 20              |
| Max. Static Load (lbs)        |             |             | 75              |
| Torque to raise 1 lb (oz-in.) |             |             | 0.14            |
| Nut weight (lbs)              |             |             | 0.005           |
| Ball Nut Part Number          |             |             | <b>7821609</b>  |
| Flange Part Number            |             |             | <b>N/A</b>      |
| Wiper Kit Part Number         |             |             | <b>N/A</b>      |

Note: Dimensional information for all End Journals and Bearing Supports is available on page 154. Information on required lubrication is on page 233.

**0.187 x 0.062****Precision Rolled Ball Screws — Inch Series**

|                             |               |
|-----------------------------|---------------|
| Diameter x Lead (in.)       | 0.187 x 0.062 |
| Lead Accuracy (in/ft)       | ± 0.004       |
| Screw Weight (lbs/ft)       | 0.1           |
| Screw Root Diameter (in.)   | 0.14          |
| Nominal Ball Diameter (in.) | 0.039         |
| Number of Starts            | 1             |

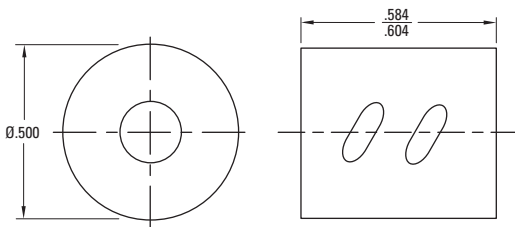
**Double Circuit, Cylindrical Ball Nut, Internal Return — Stainless Steel****Ball Screw Part Numbers**

|                  |             |             |                 |
|------------------|-------------|-------------|-----------------|
| Thread Direction | Right Hand  | Left Hand   | Right Hand      |
| Screw Material   | Alloy Steel | Alloy Steel | Stainless Steel |
| Standard Length  |             |             | 12"             |
| Maximum Length   |             |             | 12"             |
| Part Number      |             |             | <b>7821633</b>  |

Ball screws can be cut to the length you require. Specify ball screw part number and overall length at time of order.

|                               |             |             |                 |
|-------------------------------|-------------|-------------|-----------------|
| Thread Direction              | Right Hand  | Left Hand   | Right Hand      |
| Nut Material                  | Alloy Steel | Alloy Steel | Stainless Steel |
| Dynamic Load (lbs)            |             |             | 20              |
| Max. Static Load (lbs)        |             |             | 75              |
| Torque to raise 1 lb (oz-in.) |             |             | 0.18            |
| Nut weight (lbs)              |             |             | 0.005           |
| Ball Nut Part Number          |             |             | <b>7821579</b>  |
| Flange Part Number            |             |             | <b>N/A</b>      |
| Wiper Kit Part Number         |             |             | <b>N/A</b>      |

Note: Dimensional information for all End Journals and Bearing Supports is available on page 154. Information on required lubrication is on page 233.

## 0.375 x 0.125

## Precision Rolled Ball Screws — Inch Series

|                                    |               |
|------------------------------------|---------------|
| <b>Diameter x Lead (in.)</b>       | 0.375 x 0.125 |
| <b>Lead Accuracy (in/ft)</b>       | ± 0.004       |
| <b>Screw Weight (lbs/ft)</b>       | 0.3           |
| <b>Screw Root Diameter (in.)</b>   | 0.30          |
| <b>Nominal Ball Diameter (in.)</b> | 0.063         |
| <b>Number of Starts</b>            | 1             |

### Single Circuit, Round Ball Nut

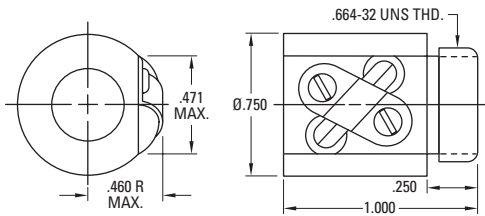

### Flange Kit

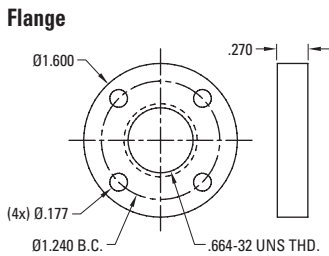

### Ball Screw Part Numbers

| Thread Direction       | Right Hand     | Left Hand      | Right Hand      |
|------------------------|----------------|----------------|-----------------|
| <b>Screw Material</b>  | Alloy Steel    | Alloy Steel    | Stainless Steel |
| <b>Standard Length</b> | 48"            | 48"            | 48"             |
| <b>Maximum Length</b>  | 48"            | 48"            | 48"             |
| <b>Part Number</b>     | <b>5707538</b> | <b>5708532</b> | <b>5706540</b>  |

Ball screws can be cut to the length you require. Specify ball screw part number and overall length at time of order.

| Direction                            | Right Hand     | Left Hand      | Right Hand      |
|--------------------------------------|----------------|----------------|-----------------|
| <b>Nut Material</b>                  | Alloy Steel    | Alloy Steel    | Stainless Steel |
| <b>Dynamic Load (lbs)</b>            | 136            | 136            | 24              |
| <b>Max. Static Load (lbs)</b>        | 1415           | 1415           | 255             |
| <b>Torque to raise 1 lb (oz-in.)</b> | 0.35           | 0.35           | 0.35            |
| <b>Nut weight (lbs)</b>              | 0.13           | 0.13           | 0.13            |
| <b>Ball Nut Part Number</b>          | <b>5709574</b> | <b>5709576</b> | <b>5709578</b>  |
| <b>Flange Part Number</b>            | <b>5706751</b> | <b>5706751</b> | <b>N/A</b>      |
| <b>Wiper Kit Part Number</b>         | <b>N/A</b>     | <b>N/A</b>     | <b>N/A</b>      |

|                           |                |  |
|---------------------------|----------------|--|
| <b>Wiper Part Number</b>  | <b>N/A</b>     |  |
| <b>Flange Part Number</b> | <b>5706751</b> |  |

Note: Dimensional information for all End Journals and Bearing Supports is available on page 154. Information on required lubrication is on page 233.



**0.375 x 0.125**

**Precision Rolled Ball Screws — Inch Series**

|                                    |               |
|------------------------------------|---------------|
| <b>Diameter x Lead (in.)</b>       | 0.375 x 0.125 |
| <b>Lead Accuracy (in/ft)</b>       | ± 0.004       |
| <b>Screw Weight (lbs/ft)</b>       | 0.3           |
| <b>Screw Root Diameter (in.)</b>   | 0.31          |
| <b>Nominal Ball Diameter (in.)</b> | 0.078         |
| <b>Number of Starts</b>            | 1             |

**Ball Screw Part Numbers**

|                         |                 |             |                 |
|-------------------------|-----------------|-------------|-----------------|
| <b>Thread Direction</b> | Right Hand      | Left Hand   | Right Hand      |
| <b>Screw Material</b>   | Alloy Steel     | Alloy Steel | Stainless Steel |
| <b>Standard Length</b>  | 72"             |             |                 |
| <b>Maximum Length</b>   | 72"             |             |                 |
| <b>Part Number</b>      | <b>190-9441</b> |             |                 |

Ball screws can be cut to the length you require. Specify ball screw part number and overall length at time of order.

**Double Circuit, Round Ball Nut with Load Lock (11/16 - 24 V-Thread)**

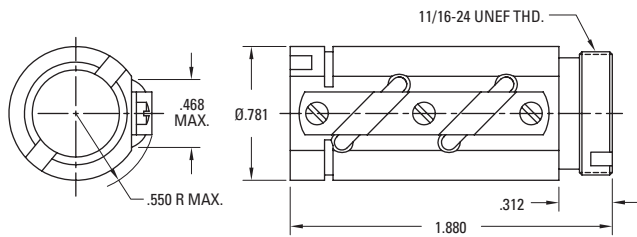

|                                      |                     |           |
|--------------------------------------|---------------------|-----------|
| <b>Thread Direction</b>              | Right Hand          | Left Hand |
| <b>Nut Material</b>                  | Alloy Steel         |           |
| <b>Dynamic Load (lbs)</b>            | 500                 |           |
| <b>Max. Static Load (lbs)</b>        | 4,250               |           |
| <b>Torque to raise 1 lb (oz-in.)</b> | 0.35                |           |
| <b>Nut weight (lbs)</b>              | 0.16                |           |
| <b>Ball Nut Part Number</b>          | <b>8103-448-003</b> |           |
| <b>Flange Part Number</b>            | <b>8103-448-002</b> |           |
| <b>Wiper Kit Part Number</b>         | <b>8103-101-002</b> |           |

**Double Circuit, Round Ball Nut with Load Lock (.664 - 32 V-Thread)**

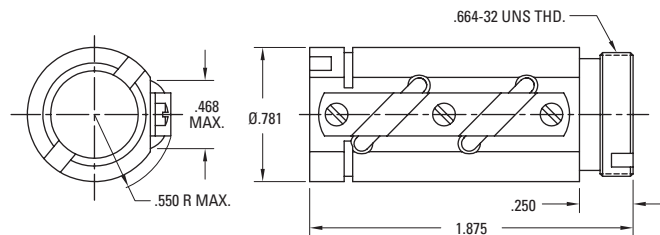

|                                      |                     |           |
|--------------------------------------|---------------------|-----------|
| <b>Thread Direction</b>              | Right Hand          | Left Hand |
| <b>Nut Material</b>                  | Alloy Steel         |           |
| <b>Dynamic Load (lbs)</b>            | 500                 |           |
| <b>Max. Static Load (lbs)</b>        | 4,250               |           |
| <b>Torque to raise 1 lb (oz-in.)</b> | 0.35                |           |
| <b>Nut weight (lbs)</b>              | 0.16                |           |
| <b>Ball Nut Part Number</b>          | <b>8103-448-013</b> |           |
| <b>Flange Part Number</b>            | <b>N/A</b>          |           |
| <b>Wiper Kit Part Number</b>         | <b>8103-101-002</b> |           |

**Wiper and Flange Kits**

**Wiper**

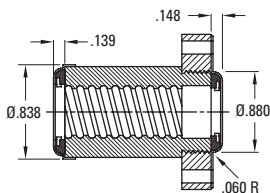

**Flange**

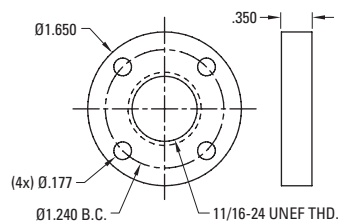

|                           |                     |  |
|---------------------------|---------------------|--|
| <b>Wiper Part Number</b>  | <b>8103-101-002</b> |  |
| <b>Flange Part Number</b> | <b>8103-448-002</b> |  |

Note: Dimensional information for all End Journals and Bearing Supports is available on page 154. Information on required lubrication is on page 233.

# 0.375 x 0.125

## Precision Rolled Ball Screws — Inch Series

|                             |               |
|-----------------------------|---------------|
| Diameter x Lead (in.)       | 0.375 x 0.125 |
| Lead Accuracy (in/ft)       | ± 0.004       |
| Screw Weight (lbs/ft)       | 0.3           |
| Screw Root Diameter (in.)   | 0.31          |
| Nominal Ball Diameter (in.) | 0.078         |
| Number of Starts            | 1             |

### Ball Screw Part Numbers

|                  |                 |             |                 |
|------------------|-----------------|-------------|-----------------|
| Thread Direction | Right Hand      | Left Hand   | Right Hand      |
| Screw Material   | Alloy Steel     | Alloy Steel | Stainless Steel |
| Standard Length  | 31"             |             |                 |
| Maximum Length   | 48"             |             |                 |
| Part Number      | <b>190-9452</b> |             |                 |

Ball screws can be cut to the length you require. Specify ball screw part number and overall length at time of order.

### Single Circuit, Cylindrical Ball Nut

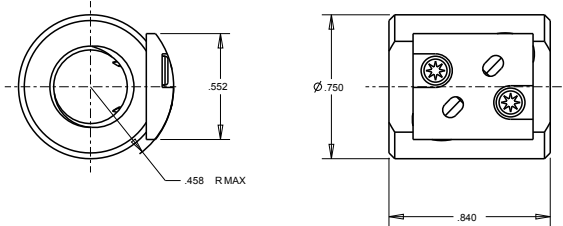

|                               |                     |           |
|-------------------------------|---------------------|-----------|
| Thread Direction              | Right Hand          | Left Hand |
| Nut Material                  | Alloy Steel         |           |
| Dynamic Load (lbs)            | 170                 |           |
| Max. Static Load (lbs)        | 1,600               |           |
| Torque to raise 1 lb (oz-in.) | 0.35                |           |
| Nut weight (lbs)              | 0.13                |           |
| Ball Nut Part Number          | <b>8103-448-017</b> |           |
| Flange Part Number            | N/A                 |           |
| Wiper Kit Part Number         | N/A                 |           |

### Single Circuit, Round Ball Nut

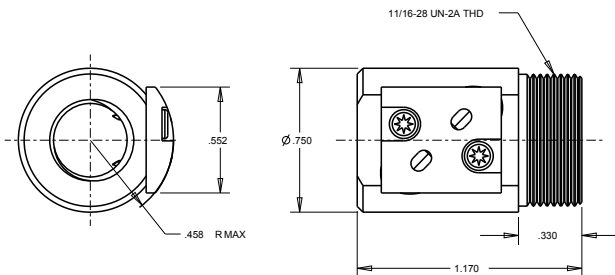

|                               |                     |           |
|-------------------------------|---------------------|-----------|
| Thread Direction              | Right Hand          | Left Hand |
| Nut Material                  | Alloy Steel         |           |
| Dynamic Load (lbs)            | 170                 |           |
| Max. Static Load (lbs)        | 1,600               |           |
| Torque to raise 1 lb (oz-in.) | 0.35                |           |
| Nut weight (lbs)              | 0.13                |           |
| Ball Nut Part Number          | <b>8103-448-018</b> |           |
| Flange Part Number            | N/A                 |           |
| Wiper Kit Part Number         | N/A                 |           |

### Wiper and Flange Kits

|                    |                     |  |
|--------------------|---------------------|--|
| Wiper Part Number  | <b>8103-101-002</b> |  |
| Flange Part Number | N/A                 |  |

#### Wiper

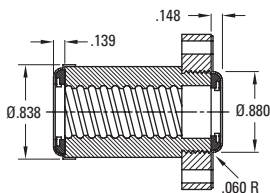

#### Flange

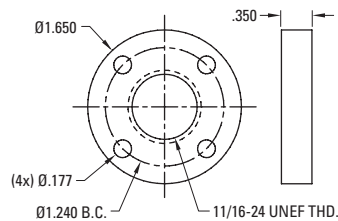

Note: Dimensional information for all End Journals and Bearing Supports is available on page 154. Information on required lubrication is on page 233.

**0.500 x 0.200**

**Precision Rolled Ball Screws — Inch Series**

|                                    |               |
|------------------------------------|---------------|
| <b>Diameter x Lead (in.)</b>       | 0.500 x 0.200 |
| <b>Lead Accuracy (in/ft)</b>       | ± 0.004       |
| <b>Screw Weight (lbs/ft)</b>       | 0.7           |
| <b>Screw Root Diameter (in.)</b>   | 0.41          |
| <b>Nominal Ball Diameter (in.)</b> | 0.125         |
| <b>Number of Starts</b>            | 1             |

**Ball Screw Part Numbers**

|                         |                 |             |                 |
|-------------------------|-----------------|-------------|-----------------|
| <b>Thread Direction</b> | Right Hand      | Left Hand   | Right Hand      |
| <b>Screw Material</b>   | Alloy Steel     | Alloy Steel | Stainless Steel |
| <b>Standard Length</b>  | 72"             |             |                 |
| <b>Maximum Length</b>   | 72"             |             |                 |
| <b>Part Number</b>      | <b>190-9097</b> |             |                 |

Ball screws can be cut to the length you require. Specify ball screw part number and overall length at time of order.

**Single Circuit, Round Ball Nut with Load Lock**

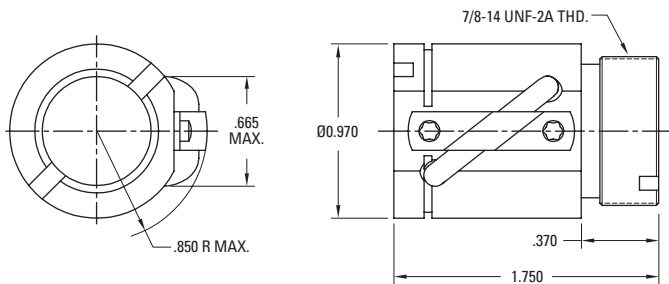

|                                      |                     |           |
|--------------------------------------|---------------------|-----------|
| <b>Thread Direction</b>              | Right Hand          | Left Hand |
| <b>Nut Material</b>                  | Alloy Steel         |           |
| <b>Dynamic Load (lbs)</b>            | 600                 |           |
| <b>Max. Static Load (lbs)</b>        | 2,975               |           |
| <b>Torque to raise 1 lb (oz-in.)</b> | 0.57                |           |
| <b>Nut weight (lbs)</b>              | 0.27                |           |
| <b>Ball Nut Part Number</b>          | <b>8105-448-023</b> |           |
| <b>Flange Part Number</b>            | <b>N/A</b>          |           |
| <b>Wiper Kit Part Number</b>         | <b>8105-101-002</b> |           |

# 0.500 x 0.200

# Precision Rolled Ball Screws — Inch Series

|                             |               |
|-----------------------------|---------------|
| Diameter x Lead (in.)       | 0.500 x 0.200 |
| Lead Accuracy (in/ft)       | ± 0.004       |
| Screw Weight (lbs/ft)       | 0.7           |
| Screw Root Diameter (in.)   | 0.41          |
| Nominal Ball Diameter (in.) | 0.125         |
| Number of Starts            | 1             |

## Ball Screw Part Numbers

|                  |                 |             |                 |
|------------------|-----------------|-------------|-----------------|
| Thread Direction | Right Hand      | Left Hand   | Right Hand      |
| Screw Material   | Alloy Steel     | Alloy Steel | Stainless Steel |
| Standard Length  | 72"             |             |                 |
| Maximum Length   | 72"             |             |                 |
| Part Number      | <b>190-9097</b> |             |                 |

Ball screws can be cut to the length you require. Specify ball screw part number and overall length at time of order.

## Double Circuit, Round Ball Nut with Load Lock

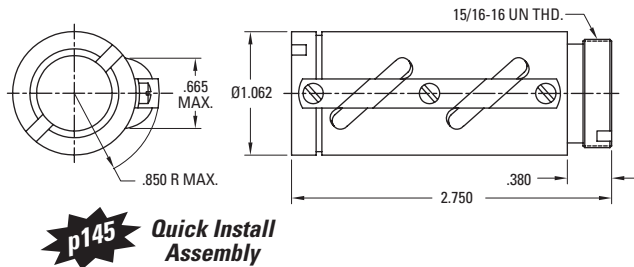

|                               |                     |           |
|-------------------------------|---------------------|-----------|
| Thread Direction              | Right Hand          | Left Hand |
| Nut Material                  | Alloy Steel         |           |
| Dynamic Load (lbs)            | 1,200               |           |
| Max. Static Load (lbs)        | 9,430               |           |
| Torque to raise 1 lb (oz-in.) | 0.57                |           |
| Nut weight (lbs)              | 0.55                |           |
| Ball Nut Part Number          | <b>8105-448-013</b> |           |
| Flange Part Number            | <b>8105-448-002</b> |           |
| Wiper Kit Part Number         | <b>8105-101-002</b> |           |

## Preloaded, Double Circuit, Round Ball Nut with Load Lock

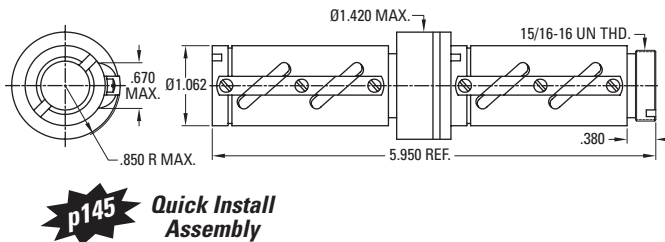

|                               |                     |           |
|-------------------------------|---------------------|-----------|
| Thread Direction              | Right Hand          | Left Hand |
| Nut Material                  | Alloy Steel         |           |
| Dynamic Load (lbs)            | 1,200               |           |
| Max. Static Load (lbs)        | 9,430               |           |
| Torque to raise 1 lb (oz-in.) | 0.57                |           |
| Nut weight (lbs)              | 1.30                |           |
| Ball Nut Part Number          | <b>8105-448-008</b> |           |
| Flange Part Number            | <b>8105-448-002</b> |           |
| Wiper Kit Part Number         | <b>8105-101-002</b> |           |

## Wiper and Flange Kits

### Wiper

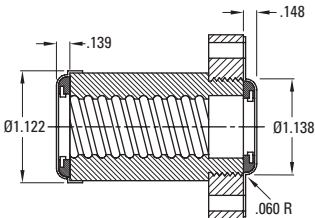

### Flange

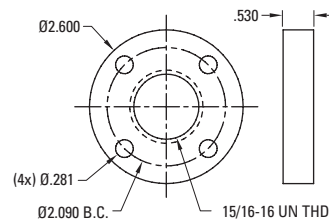

|                    |                     |  |
|--------------------|---------------------|--|
| Wiper Part Number  | <b>8105-101-002</b> |  |
| Flange Part Number | <b>8105-448-002</b> |  |

Note: Dimensional information for all End Journals and Bearing Supports is available on page 154. Information on required lubrication is on page 233.

**0.500 x 0.500**

**Precision Rolled Ball Screws — Inch Series**

|                             |               |
|-----------------------------|---------------|
| Diameter x Lead (in.)       | 0.500 x 0.500 |
| Lead Accuracy (in/ft)       | ± 0.004       |
| Screw Weight (lbs/ft)       | 0.7           |
| Screw Root Diameter (in.)   | 0.41          |
| Nominal Ball Diameter (in.) | 0.125         |
| Number of Starts            | 2             |

**Ball Screw Part Numbers**

|                  |                 |             |                 |
|------------------|-----------------|-------------|-----------------|
| Thread Direction | Right Hand      | Left Hand   | Right Hand      |
| Screw Material   | Alloy Steel     | Alloy Steel | Stainless Steel |
| Standard Length  | 72"             |             | 72"             |
| Maximum Length   | 72"             |             | 72"             |
| Part Number      | <b>190-9096</b> |             | <b>190-9010</b> |

Ball screws can be cut to the length you require. Specify ball screw part number and overall length at time of order.

**Double Circuit, Round Ball Nut**

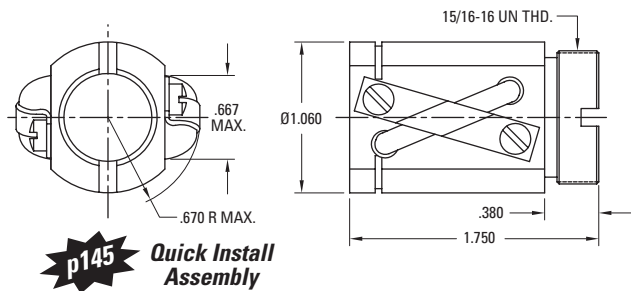

|                               |                     |           |
|-------------------------------|---------------------|-----------|
| Thread Direction              | Right Hand          | Left Hand |
| Nut Material                  | Alloy Steel         |           |
| Dynamic Load (lbs)            | 929                 |           |
| Max. Static Load (lbs)        | 4,150               |           |
| Torque to raise 1 lb (oz-in.) | 1.42                |           |
| Nut weight (lbs)              | 0.27                |           |
| Ball Nut Part Number          | <b>8105-448-014</b> |           |
| Flange Part Number            | <b>8105-448-002</b> |           |
| Wiper Kit Part Number         | <b>8105-101-002</b> |           |

**Double Circuit, Round Ball Nut with Load Lock — High Capacity**

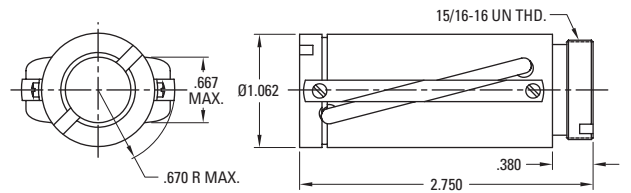

|                               |                     |             |                                   |
|-------------------------------|---------------------|-------------|-----------------------------------|
| Thread Direction              | Right Hand          | Left Hand   | Right Hand                        |
| Nut Material                  | Alloy Steel         | Alloy Steel | Stainless Steel                   |
| Dynamic Load (lbs)            | 2,200               |             | 380                               |
| Max. Static Load (lbs)        | 13,350              |             | 1,950                             |
| Torque to raise 1 lb (oz-in.) | 1.42                |             | 1.42                              |
| Nut weight (lbs)              | 0.40                |             | 0.40                              |
| Ball Nut Part Number          | <b>8105-448-011</b> |             | <b>8105-448-016<sup>(1)</sup></b> |
| Flange Part Number            | <b>8105-448-002</b> |             | <b>8105-448-004</b>               |
| Wiper Kit Part Number         | <b>8105-101-002</b> |             | <b>8105-101-002</b>               |

(1) Load Lock not available

**Wiper and Flange Kits**

**Wiper**

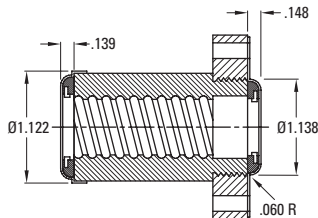

**Flange**

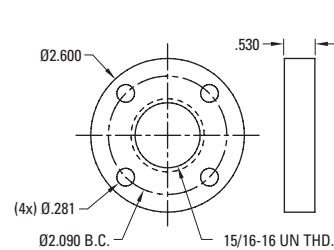

|                    |                     |  |                     |
|--------------------|---------------------|--|---------------------|
| Wiper Part Number  | <b>8105-101-002</b> |  | <b>8105-101-002</b> |
| Flange Part Number | <b>8105-448-002</b> |  | <b>8105-448-004</b> |

Note: Dimensional information for all End Journals and Bearing Supports is available on page 154. Information on required lubrication is on page 233.

# 0.631 x 0.200

## Precision Rolled Ball Screws — Inch Series

|                                    |               |
|------------------------------------|---------------|
| <b>Diameter x Lead (in.)</b>       | 0.631 x 0.200 |
| <b>Lead Accuracy (in/ft)</b>       | ± 0.004       |
| <b>Screw Weight (lbs/ft)</b>       | 0.9           |
| <b>Screw Root Diameter (in.)</b>   | 0.50          |
| <b>Nominal Ball Diameter (in.)</b> | 0.125         |
| <b>Number of Starts</b>            | 1             |

### Ball Screw Part Numbers

| Thread Direction       | Right Hand      | Left Hand       | Right Hand      |
|------------------------|-----------------|-----------------|-----------------|
| <b>Screw Material</b>  | Alloy Steel     | Alloy Steel     | Stainless Steel |
| <b>Standard Length</b> | 72"             | 72"             | 72"             |
| <b>Maximum Length</b>  | 144"            | 144"            | 72"             |
| <b>Part Number</b>     | <b>190-9098</b> | <b>190-9099</b> | <b>5705378</b>  |

Ball screws can be cut to the length you require. Specify ball screw part number and overall length at time of order.

### Single Circuit, Square Ball Nut with Load Lock

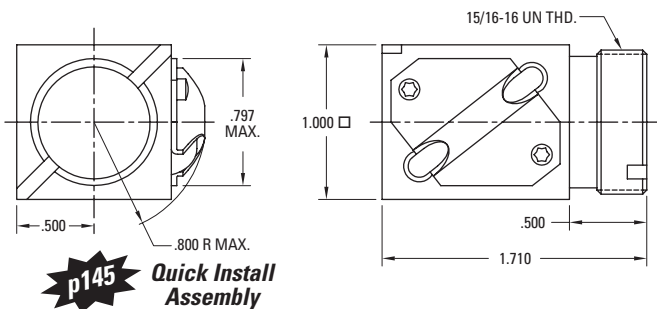

| Thread Direction                     | Right Hand          | Left Hand           |
|--------------------------------------|---------------------|---------------------|
| <b>Nut Material</b>                  | Alloy Steel         | Alloy Steel         |
| <b>Dynamic Load (lbs)</b>            | 800                 | 800                 |
| <b>Max. Static Load (lbs)</b>        | 6,384               | 6,384               |
| <b>Torque to raise 1 lb (oz-in.)</b> | 0.57                | 0.57                |
| <b>Nut weight (lbs)</b>              | 0.27                | 0.27                |
| <b>Ball Nut Part Number</b>          | <b>8106-448-022</b> | <b>8106-448-026</b> |
| <b>Flange Part Number</b>            | <b>8105-448-002</b> | <b>8105-448-002</b> |
| <b>Wiper Kit Part Number</b>         | <b>N/A</b>          | <b>N/A</b>          |

### Single Circuit, Square Ball Nut – Stainless Steel

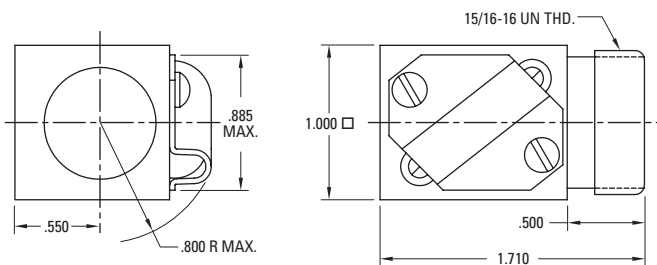

| Thread Direction                     | Right Hand  | Left Hand   | Right Hand      |
|--------------------------------------|-------------|-------------|-----------------|
| <b>Nut Material</b>                  | Alloy Steel | Alloy Steel | Stainless Steel |
| <b>Dynamic Load (lbs)</b>            |             |             | 140             |
| <b>Max. Static Load (lbs)</b>        |             |             | 1,149           |
| <b>Torque to raise 1 lb (oz-in.)</b> |             |             | 0.57            |
| <b>Nut weight (lbs)</b>              |             |             | 0.27            |
| <b>Ball Nut Part Number</b>          |             |             | <b>5707645</b>  |
| <b>Flange Part Number</b>            |             |             | <b>N/A</b>      |
| <b>Wiper Kit Part Number</b>         |             |             | <b>N/A</b>      |

### Single Circuit, Round Ball Nut with Load Lock

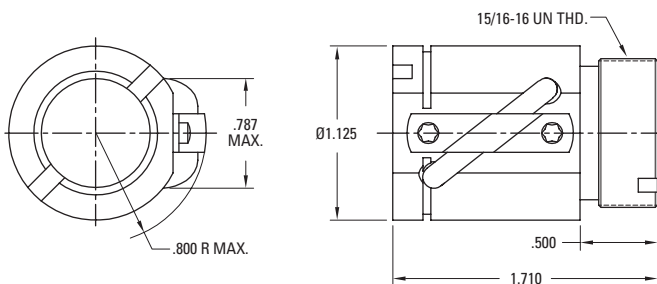

| Thread Direction                     | Right Hand          | Left Hand                         |
|--------------------------------------|---------------------|-----------------------------------|
| <b>Nut Material</b>                  | Alloy Steel         | Alloy Steel                       |
| <b>Dynamic Load (lbs)</b>            | 800                 | 800                               |
| <b>Max. Static Load (lbs)</b>        | 6,384               | 6,384                             |
| <b>Torque to raise 1 lb (oz-in.)</b> | 0.57                | 0.57                              |
| <b>Nut weight (lbs)</b>              | 0.27                | 0.27                              |
| <b>Ball Nut Part Number</b>          | <b>8106-448-009</b> | <b>8106-448-008<sup>(1)</sup></b> |
| <b>Flange Part Number</b>            | <b>8105-448-002</b> | <b>8105-448-002</b>               |
| <b>Wiper Kit Part Number</b>         | <b>8106-101-002</b> | <b>8106-101-002</b>               |

1) Load Lock not available

Note: Dimensional information for all End Journals and Bearing Supports is available on page 154. Information on required lubrication is on page 233.

**0.631 x 0.200**

**Precision Rolled Ball Screws — Inch Series**

|                             |               |
|-----------------------------|---------------|
| Diameter x Lead (in.)       | 0.631 x 0.200 |
| Lead Accuracy (in/ft)       | ± 0.004       |
| Screw Weight (lbs/ft)       | 0.9           |
| Screw Root Diameter (in.)   | 0.50          |
| Nominal Ball Diameter (in.) | 0.125         |
| Number of Starts            | 1             |

**Preloaded, Single Circuit, Round Ball Nut**

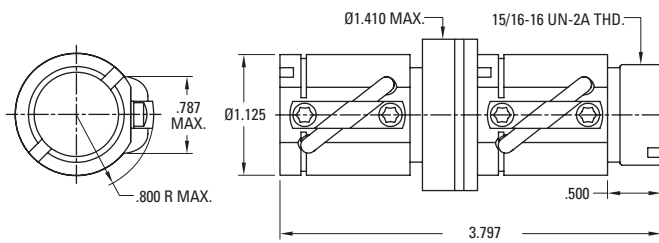

**Preloaded, Square Ball Nut**

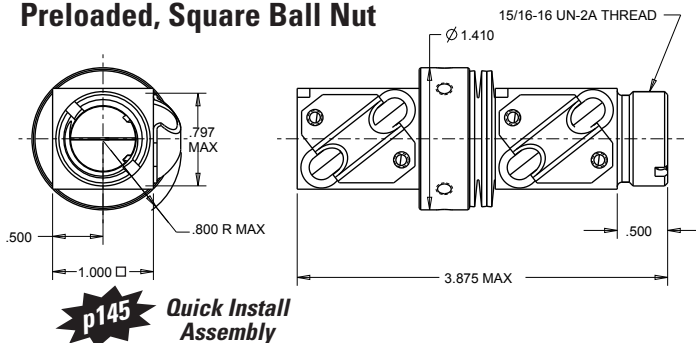

**Double Circuit, Square Ball Nut**

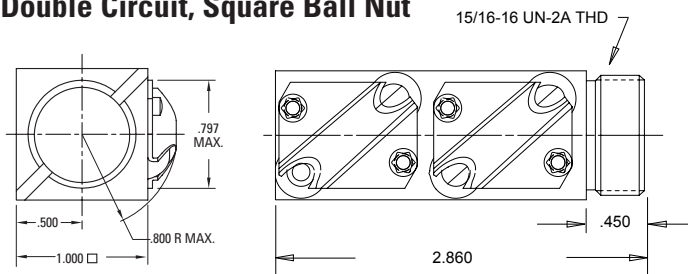

**Wiper and Flange Kits**

**Wiper**

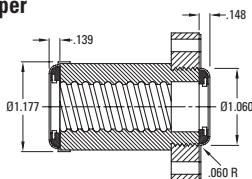

**Flange**

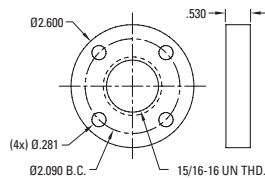

**Ball Screw Part Numbers**

|                  |             |             |
|------------------|-------------|-------------|
| Thread Direction | Right Hand  | Left Hand   |
| Screw Material   | Alloy Steel | Alloy Steel |
| Standard Length  | 72"         | 72"         |
| Maximum Length   | 144"        | 144"        |
| Part Number      | 190-9098    | 190-9099    |

Ball screws can be cut to the length you require. Specify ball screw part number and overall length at time of order.

|                               |              |              |
|-------------------------------|--------------|--------------|
| Thread Direction              | Right Hand   | Left Hand    |
| Nut Material                  | Alloy Steel  | Alloy Steel  |
| Dynamic Load (lbs)            | 800          | 800          |
| Max. Static Load (lbs)        | 6,384        | 6,384        |
| Torque to raise 1 lb (oz-in.) | 0.57         | 0.57         |
| Nut weight (lbs)              | 0.79         | 0.79         |
| Ball Nut Part Number          | 8106-448-015 | 8106-448-019 |
| Flange Part Number            | 8105-448-002 | 8105-448-002 |
| Wiper Kit Part Number         | 8106-101-002 | 8106-101-002 |

|                               |              |
|-------------------------------|--------------|
| Thread Direction              | Right Hand   |
| Nut Material                  | Alloy Steel  |
| Dynamic Load (lbs)            | 800          |
| Max. Static Load (lbs)        | 6,384        |
| Torque to raise 1 lb (oz-in.) | 0.57         |
| Nut weight (lbs)              | 0.79         |
| Ball Nut Part Number          | 8106-448-012 |
| Flange Part Number            | 8105-448-002 |
| Wiper Kit Part Number         | N/A          |

|                               |              |
|-------------------------------|--------------|
| Thread Direction              | Right Hand   |
| Nut Material                  | Alloy Steel  |
| Dynamic Load (lbs)            | 1,600        |
| Max. Static Load (lbs)        | 12,768       |
| Torque to raise 1 lb (oz-in.) | 0.57         |
| Nut weight (lbs)              | 0.54         |
| Ball Nut Part Number          | 8106-448-036 |
| Flange Part Number            | 8105-448-002 |
| Wiper Kit Part Number         | N/A          |

|                    |              |
|--------------------|--------------|
| Wiper Part Number  | 8106-101-002 |
| Flange Part Number | 8105-448-002 |

Note: Dimensional information for all End Journals and Bearing Supports is available on page 154. Information on required lubrication is on page 233.

# 0.631 x 0.200

## Precision Rolled Ball Screws — Inch Series

|                                    |               |
|------------------------------------|---------------|
| <b>Diameter x Lead (in.)</b>       | 0.631 x 0.200 |
| <b>Lead Accuracy (in/ft)</b>       | ± 0.004       |
| <b>Screw Weight (lbs/ft)</b>       | 0.9           |
| <b>Screw Root Diameter (in.)</b>   | 0.50          |
| <b>Nominal Ball Diameter (in.)</b> | 0.138         |
| <b>Number of Starts</b>            | 1             |

### Triple Circuit, Internal Return, Round Ball Nut

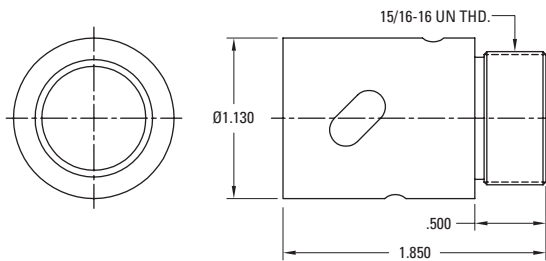

### Flange Kit

#### Flange

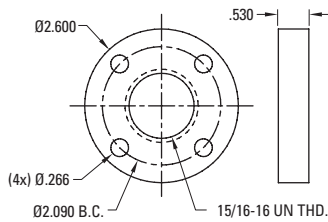

### Ball Screw Part Numbers

|                         |                   |             |                 |
|-------------------------|-------------------|-------------|-----------------|
| <b>Thread Direction</b> | Right Hand        | Left Hand   | Right Hand      |
| <b>Screw Material</b>   | Alloy Steel       | Alloy Steel | Stainless Steel |
| <b>Standard Length</b>  | 118"              |             |                 |
| <b>Maximum Length</b>   | 118"              |             |                 |
| <b>Part Number</b>      | <b>7832873-T7</b> |             |                 |

Ball screws can be cut to the length you require. Specify ball screw part number and overall length at time of order.

|                                      |                 |           |
|--------------------------------------|-----------------|-----------|
| <b>Thread Direction</b>              | Right Hand      | Left Hand |
| <b>Nut Material</b>                  | Alloy Steel     |           |
| <b>Dynamic Load (lbs)</b>            | 650             |           |
| <b>Max. Static Load (lbs)</b>        | 4,950           |           |
| <b>Torque to raise 1 lb (oz-in.)</b> | 0.57            |           |
| <b>Nut weight (lbs)</b>              | 0.27            |           |
| <b>Ball Nut Part Number</b>          | <b>7832872</b>  |           |
| <b>Flange Part Number</b>            | <b>5707570</b>  |           |
| <b>Wiper Kit Part Number</b>         | <b>Internal</b> |           |

|                           |                |  |
|---------------------------|----------------|--|
| <b>Wiper Part Number</b>  | <b>N/A</b>     |  |
| <b>Flange Part Number</b> | <b>5707570</b> |  |

Note: Dimensional information for all End Journals and Bearing Supports is available on page 154. Information on required lubrication is on page 233.



**0.631 x 0.200**

**Precision Rolled Ball Screws — Inch Series**

|                                    |               |
|------------------------------------|---------------|
| <b>Diameter x Lead (in.)</b>       | 0.631 x 0.200 |
| <b>Lead Accuracy (in/ft)</b>       | ± 0.004       |
| <b>Screw Weight (lbs/ft)</b>       | 0.9           |
| <b>Screw Root Diameter (in.)</b>   | 0.50          |
| <b>Nominal Ball Diameter (in.)</b> | 0.125         |
| <b>Number of Starts</b>            | 1             |

**Ball Screw Part Numbers**

|                         |             |                 |                 |
|-------------------------|-------------|-----------------|-----------------|
| <b>Thread Direction</b> | Right Hand  | Left Hand       | Right Hand      |
| <b>Screw Material</b>   | Alloy Steel | Alloy Steel     | Stainless Steel |
| <b>Standard Length</b>  |             | 72"             |                 |
| <b>Maximum Length</b>   |             | 144"            |                 |
| <b>Part Number</b>      |             | <b>190-9099</b> |                 |

Ball screws can be cut to the length you require. Specify ball screw part number and overall length at time of order.

**Double Circuit, Square Ball Nut**

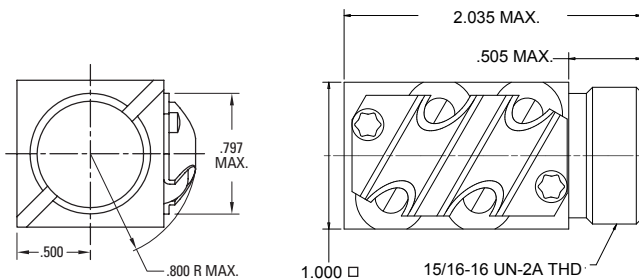

|                                      |            |                     |
|--------------------------------------|------------|---------------------|
| <b>Thread Direction</b>              | Right Hand | Left Hand           |
| <b>Nut Material</b>                  |            | Alloy Steel         |
| <b>Dynamic Load (lbs)</b>            |            | 1,600               |
| <b>Max. Static Load (lbs)</b>        |            | 12,768              |
| <b>Torque to raise 1 lb (oz-in.)</b> |            | 0.57                |
| <b>Nut weight (lbs)</b>              |            | 0.54                |
| <b>Ball Nut Part Number</b>          |            | <b>8106-448-037</b> |
| <b>Flange Part Number</b>            |            | <b>8105-448-002</b> |
| <b>Wiper Kit Part Number</b>         |            | <b>N/A</b>          |

**Flange Kit**

**Flange**

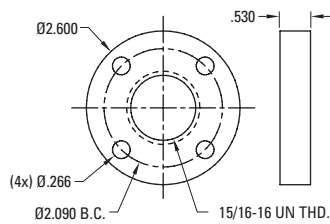

|                           |  |                |
|---------------------------|--|----------------|
| <b>Wiper Part Number</b>  |  | <b>N/A</b>     |
| <b>Flange Part Number</b> |  | <b>5707570</b> |

Note: Dimensional information for all End Journals and Bearing Supports is available on page 154. Information on required lubrication is on page 233.

# 0.631 x 1.000

## Precision Rolled Ball Screws — Inch Series

|                             |               |
|-----------------------------|---------------|
| Diameter x Lead (in.)       | 0.631 x 1.000 |
| Lead Accuracy (in/ft)       | ± 0.004       |
| Screw Weight (lbs/ft)       | 0.8           |
| Screw Root Diameter (in.)   | 0.48          |
| Nominal Ball Diameter (in.) | 0.125         |
| Number of Starts            | 4             |

### Ball Screw Part Numbers

|                  |                |             |                 |
|------------------|----------------|-------------|-----------------|
| Thread Direction | Right Hand     | Left Hand   | Right Hand      |
| Screw Material   | Alloy Steel    | Alloy Steel | Stainless Steel |
| Standard Length  | 72"            |             |                 |
| Maximum Length   | 96"            |             |                 |
| Part Number      | <b>7826712</b> |             |                 |

Ball screws can be cut to the length you require. Specify ball screw part number and overall length at time of order.

### Double Circuit, Round Ball Nut

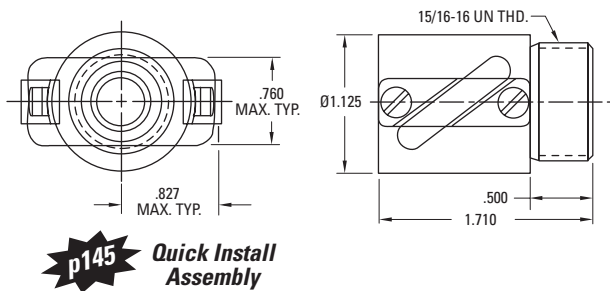

|                               |                |           |
|-------------------------------|----------------|-----------|
| Thread Direction              | Right Hand     | Left Hand |
| Nut Material                  | Alloy Steel    |           |
| Dynamic Load (lbs)            | 578            |           |
| Max. Static Load (lbs)        | 2,425          |           |
| Torque to raise 1 lb (oz-in.) | 2.83           |           |
| Nut weight (lbs)              | 0.28           |           |
| Ball Nut Part Number          | <b>7826713</b> |           |
| Flange Part Number            | <b>5707570</b> |           |
| Wiper Kit Part Number         | <b>7827527</b> |           |

### Preloaded, Double Circuit, Round Ball Nut

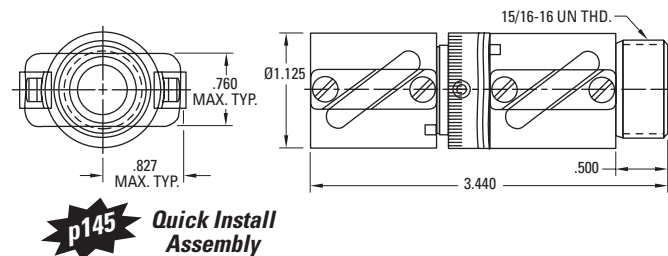

|                               |                |           |
|-------------------------------|----------------|-----------|
| Thread Direction              | Right Hand     | Left Hand |
| Nut Material                  | Alloy Steel    |           |
| Dynamic Load (lbs)            | 578            |           |
| Max. Static Load (lbs)        | 2,425          |           |
| Torque to raise 1 lb (oz-in.) | 2.83           |           |
| Nut weight (lbs)              | 0.67           |           |
| Ball Nut Part Number          | <b>7827531</b> |           |
| Flange Part Number            | <b>5707570</b> |           |
| Wiper Kit Part Number         | <b>7827527</b> |           |

### Wiper and Flange Kits

#### Wiper

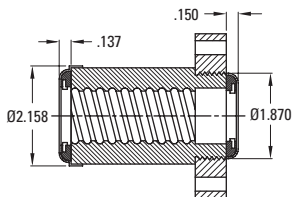

#### Flange

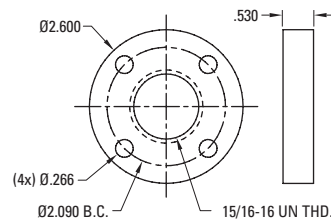

Note: Wiper kit does not include flange end cap.

|                    |                |  |
|--------------------|----------------|--|
| Wiper Part Number  | <b>7827527</b> |  |
| Flange Part Number | <b>5707570</b> |  |

Note: Dimensional information for all End Journals and Bearing Supports is available on page 154. Information on required lubrication is on page 233.

**0.750 x 0.200**

**Precision Rolled Ball Screws — Inch Series**

|                             |               |
|-----------------------------|---------------|
| Diameter x Lead (in.)       | 0.750 x 0.200 |
| Lead Accuracy (in/ft)       | ± 0.004       |
| Screw Weight (lbs/ft)       | 1.4           |
| Screw Root Diameter (in.)   | 0.66          |
| Nominal Ball Diameter (in.) | 0.125         |
| Number of Starts            | 1             |

**Single Circuit, Round Ball Nut with Load Lock (1.173 - 18 V-Thread)**

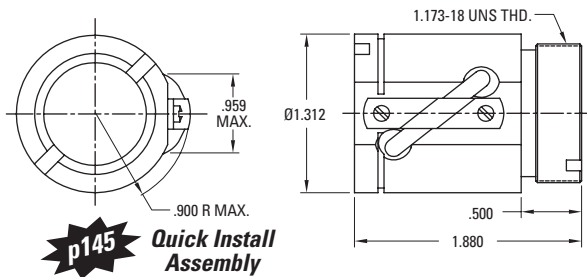

**Single Circuit, Round Ball Nut (1.125 - 18 V-Thread)**

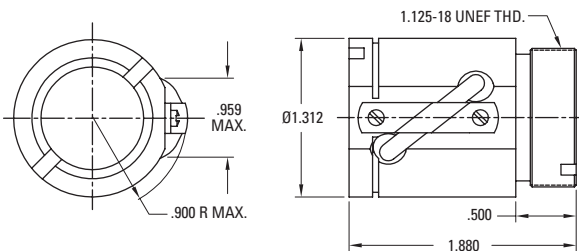

**Single Circuit, Round Ball Nut (1.250 - 18 V-Thread)**

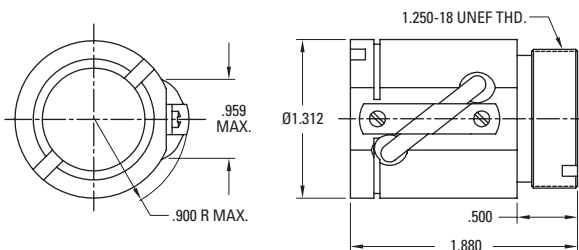

**Ball Screw Part Numbers**

|                  |                 |             |                 |
|------------------|-----------------|-------------|-----------------|
| Thread Direction | Right Hand      | Left Hand   | Right Hand      |
| Screw Material   | Alloy Steel     | Alloy Steel | Stainless Steel |
| Standard Length  | 72"             |             |                 |
| Maximum Length   | 144"            |             |                 |
| Part Number      | <b>190-9101</b> |             |                 |

Ball screws can be cut to the length you require. Specify ball screw part number and overall length at time of order.

|                               |                     |           |
|-------------------------------|---------------------|-----------|
| Thread Direction              | Right Hand          | Left Hand |
| Nut Material                  | Alloy Steel         |           |
| Dynamic Load (lbs)            | 950                 |           |
| Max. Static Load (lbs)        | 7,750               |           |
| Torque to raise 1 lb (oz-in.) | 0.57                |           |
| Nut weight (lbs)              | 0.50                |           |
| Ball Nut Part Number          | <b>8107-448-018</b> |           |
| Flange Part Number            | <b>8107-448-007</b> |           |
| Wiper Kit Part Number         | <b>8107-101-002</b> |           |

|                               |                     |           |
|-------------------------------|---------------------|-----------|
| Thread Direction              | Right Hand          | Left Hand |
| Nut Material                  | Alloy Steel         |           |
| Dynamic Load (lbs)            | 950                 |           |
| Max. Static Load (lbs)        | 7,750               |           |
| Torque to raise 1 lb (oz-in.) | 0.57                |           |
| Nut weight (lbs)              | 0.50                |           |
| Ball Nut Part Number          | <b>8107-448-026</b> |           |
| Flange Part Number            | <b>N/A</b>          |           |
| Wiper Kit Part Number         | <b>N/A</b>          |           |

|                               |                     |           |
|-------------------------------|---------------------|-----------|
| Thread Direction              | Right Hand          | Left Hand |
| Nut Material                  | Carbon Steel        |           |
| Dynamic Load (lbs)            | 950                 |           |
| Max. Static Load (lbs)        | 7,750               |           |
| Torque to raise 1 lb (oz-in.) | 0.57                |           |
| Nut weight (lbs)              | 0.50                |           |
| Ball Nut Part Number          | <b>8107-448-047</b> |           |
| Flange Part Number            | <b>N/A</b>          |           |
| Wiper Kit Part Number         | <b>N/A</b>          |           |

Note: Dimensional information for all End Journals and Bearing Supports is available on page 154. Information on required lubrication is on page 233.

**0.750 x 0.200**

**Precision Rolled Ball Screws — Inch Series**

|                                    |               |
|------------------------------------|---------------|
| <b>Diameter x Lead (in.)</b>       | 0.750 x 0.200 |
| <b>Lead Accuracy (in/ft)</b>       | ± 0.004       |
| <b>Screw Weight (lbs/ft)</b>       | 1.4           |
| <b>Screw Root Diameter (in.)</b>   | 0.66          |
| <b>Nominal Ball Diameter (in.)</b> | 0.125         |
| <b>Number of Starts</b>            | 1             |

**Double Circuit, Round Ball Nut with Load Lock (1.173 - 18 V-Thread)**

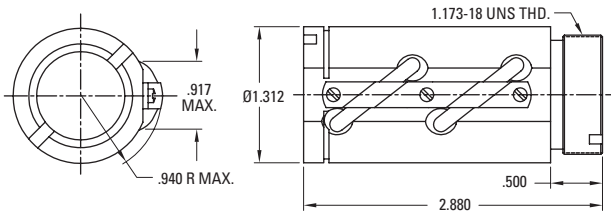

**Double Circuit, Round Ball Nut with Load Lock (1.125 - 18 V-Thread)**

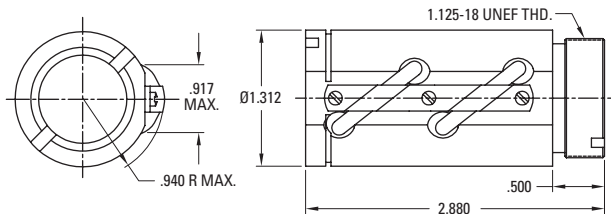

**Double Circuit, Round Ball Nut with Load Lock (1.250 - 18 V-Thread)**

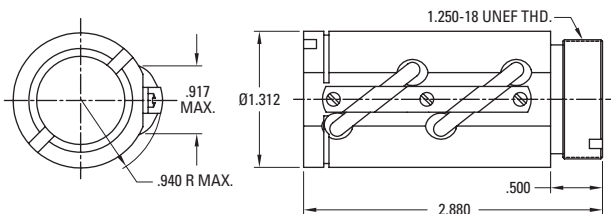

**Ball Screw Part Numbers**

|                         |                 |             |                 |
|-------------------------|-----------------|-------------|-----------------|
| <b>Thread Direction</b> | Right Hand      | Left Hand   | Right Hand      |
| <b>Screw Material</b>   | Alloy Steel     | Alloy Steel | Stainless Steel |
| <b>Standard Length</b>  | 72"             |             |                 |
| <b>Maximum Length</b>   | 144"            |             |                 |
| <b>Part Number</b>      | <b>190-9101</b> |             |                 |

Ball screws can be cut to the length you require. Specify ball screw part number and overall length at time of order.

|                                      |                     |           |
|--------------------------------------|---------------------|-----------|
| <b>Thread Direction</b>              | Right Hand          | Left Hand |
| <b>Nut Material</b>                  | Alloy Steel         |           |
| <b>Dynamic Load (lbs)</b>            | 1,900               |           |
| <b>Max. Static Load (lbs)</b>        | 18,800              |           |
| <b>Torque to raise 1 lb (oz-in.)</b> | 0.57                |           |
| <b>Nut weight (lbs)</b>              | 0.75                |           |
| <b>Ball Nut Part Number</b>          | <b>8107-448-016</b> |           |
| <b>Flange Part Number</b>            | <b>8107-448-007</b> |           |
| <b>Wiper Kit Part Number</b>         | <b>8107-101-002</b> |           |

|                                      |                     |           |
|--------------------------------------|---------------------|-----------|
| <b>Thread Direction</b>              | Right Hand          | Left Hand |
| <b>Nut Material</b>                  | Alloy Steel         |           |
| <b>Dynamic Load (lbs)</b>            | 1,900               |           |
| <b>Max. Static Load (lbs)</b>        | 18,800              |           |
| <b>Torque to raise 1 lb (oz-in.)</b> | 0.57                |           |
| <b>Nut weight (lbs)</b>              | 0.75                |           |
| <b>Ball Nut Part Number</b>          | <b>8107-448-027</b> |           |
| <b>Flange Part Number</b>            | <b>N/A</b>          |           |
| <b>Wiper Kit Part Number</b>         | <b>N/A</b>          |           |

|                                      |                     |           |
|--------------------------------------|---------------------|-----------|
| <b>Thread Direction</b>              | Right Hand          | Left Hand |
| <b>Nut Material</b>                  | Alloy Steel         |           |
| <b>Dynamic Load (lbs)</b>            | 1,900               |           |
| <b>Max. Static Load (lbs)</b>        | 18,800              |           |
| <b>Torque to raise 1 lb (oz-in.)</b> | 0.57                |           |
| <b>Nut weight (lbs)</b>              | 0.75                |           |
| <b>Ball Nut Part Number</b>          | <b>8107-448-046</b> |           |
| <b>Flange Part Number</b>            | <b>N/A</b>          |           |
| <b>Wiper Kit Part Number</b>         | <b>N/A</b>          |           |

Note: Dimensional information for all End Journals and Bearing Supports is available on page 154. Information on required lubrication is on page 233.

**0.750 x 0.200**

**Precision Rolled Ball Screws — Inch Series**

|                             |               |
|-----------------------------|---------------|
| Diameter x Lead (in.)       | 0.750 x 0.200 |
| Lead Accuracy (in/ft)       | ± 0.004       |
| Screw Weight (lbs/ft)       | 1.4           |
| Screw Root Diameter (in.)   | 0.66          |
| Nominal Ball Diameter (in.) | 0.125         |
| Number of Starts            | 1             |

**Ball Screw Part Numbers**

|                  |                 |             |                 |
|------------------|-----------------|-------------|-----------------|
| Thread Direction | Right Hand      | Left Hand   | Right Hand      |
| Screw Material   | Alloy Steel     | Alloy Steel | Stainless Steel |
| Standard Length  | 72"             |             |                 |
| Maximum Length   | 144"            |             |                 |
| Part Number      | <b>190-9101</b> |             |                 |

Ball screws can be cut to the length you require. Specify ball screw part number and overall length at time of order.

**Preloaded, Single Circuit, Round Ball Nut (1.173 - 18 V-Thread)**

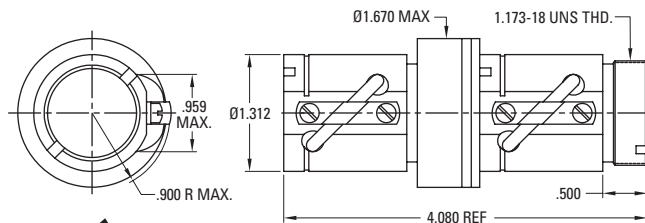

**p145** Quick Install Assembly

|                               |                     |           |
|-------------------------------|---------------------|-----------|
| Thread Direction              | Right Hand          | Left Hand |
| Nut Material                  | Alloy Steel         |           |
| Dynamic Load (lbs)            | 950                 |           |
| Max. Static Load (lbs)        | 7,750               |           |
| Torque to raise 1 lb (oz-in.) | 0.57                |           |
| Nut weight (lbs)              | 1.20                |           |
| Ball Nut Part Number          | <b>8107-448-025</b> |           |
| Flange Part Number            | <b>8107-448-007</b> |           |
| Wiper Kit Part Number         | <b>8107-101-002</b> |           |

**Wiper and Flange Kits**

**Wiper**

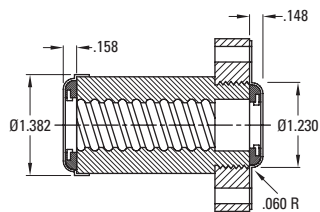

**Flange**

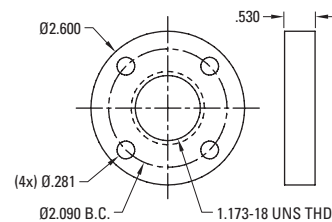

|                    |                     |  |
|--------------------|---------------------|--|
| Wiper Part Number  | <b>8107-101-002</b> |  |
| Flange Part Number | <b>8107-448-007</b> |  |

Note: Dimensional information for all End Journals and Bearing Supports is available on page 154. Information on required lubrication is on page 233.

**0.750 x 0.500**

**Precision Rolled Ball Screws — Inch Series**

|                                    |               |
|------------------------------------|---------------|
| <b>Diameter x Lead (in.)</b>       | 0.750 x 0.500 |
| <b>Lead Accuracy (in/ft)</b>       | ± 0.004       |
| <b>Screw Weight (lbs/ft)</b>       | 1.4           |
| <b>Screw Root Diameter (in.)</b>   | 0.63          |
| <b>Nominal Ball Diameter (in.)</b> | 0.156         |
| <b>Number of Starts</b>            | 2             |

**Double Circuit, Round Ball Nut with Load Lock (1.250 - 16 V-Thread)**

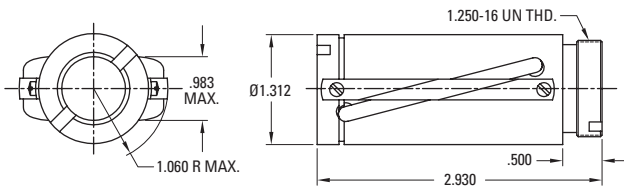

**p145** Quick Install Assembly

**Double Circuit, Round Ball Nut with Load Lock (1.173 - 18 V-Thread)**

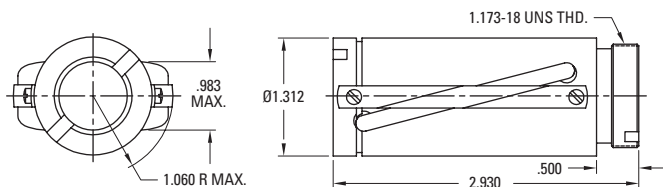

**Double Circuit, Round Ball Nut with Load Lock (1.250 - 18 V-Thread)**

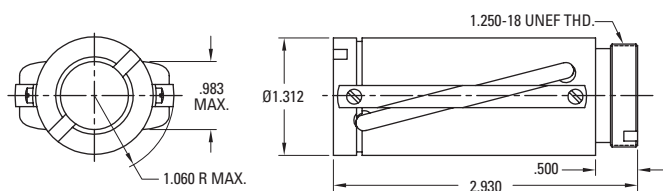

**Ball Screw Part Numbers**

| Thread Direction       | Right Hand      | Left Hand   | Right Hand      |
|------------------------|-----------------|-------------|-----------------|
| <b>Screw Material</b>  | Alloy Steel     | Alloy Steel | Stainless Steel |
| <b>Standard Length</b> | 72"             |             | 72"             |
| <b>Maximum Length</b>  | 144"            |             | 144"            |
| <b>Part Number</b>     | <b>190-9100</b> |             | <b>190-9006</b> |

Ball screws can be cut to the length you require. Specify ball screw part number and overall length at time of order.

| Thread Direction                     | Right Hand          | Left Hand   | Right Hand                        |
|--------------------------------------|---------------------|-------------|-----------------------------------|
| <b>Nut Material</b>                  | Alloy Steel         | Alloy Steel | Stainless Steel                   |
| <b>Dynamic Load (lbs)</b>            | 3,450               |             | 600                               |
| <b>Max. Static Load (lbs)</b>        | 24,200              |             | 3,460                             |
| <b>Torque to raise 1 lb (oz-in.)</b> | 1.42                |             | 1.42                              |
| <b>Nut weight (lbs)</b>              | 0.80                |             | 0.80                              |
| <b>Ball Nut Part Number</b>          | <b>8107-448-014</b> |             | <b>8107-448-020<sup>(1)</sup></b> |
| <b>Flange Part Number</b>            | <b>8107-448-002</b> |             | <b>8107-448-004</b>               |
| <b>Wiper Kit Part Number</b>         | <b>8107-101-002</b> |             | <b>8107-101-002</b>               |

(1) Load Lock not available

| Thread Direction                     | Right Hand          | Left Hand |
|--------------------------------------|---------------------|-----------|
| <b>Nut Material</b>                  | Alloy Steel         |           |
| <b>Dynamic Load (lbs)</b>            | 3,450               |           |
| <b>Max. Static Load (lbs)</b>        | 24,200              |           |
| <b>Torque to raise 1 lb (oz-in.)</b> | 1.42                |           |
| <b>Nut weight (lbs)</b>              | 0.80                |           |
| <b>Ball Nut Part Number</b>          | <b>8107-448-049</b> |           |
| <b>Flange Part Number</b>            | <b>N/A</b>          |           |
| <b>Wiper Kit Part Number</b>         | <b>N/A</b>          |           |

| Thread Direction                     | Right Hand          | Left Hand |
|--------------------------------------|---------------------|-----------|
| <b>Nut Material</b>                  | Alloy Steel         |           |
| <b>Dynamic Load (lbs)</b>            | 3,450               |           |
| <b>Max. Static Load (lbs)</b>        | 24,200              |           |
| <b>Torque to raise 1 lb (oz-in.)</b> | 1.42                |           |
| <b>Nut weight (lbs)</b>              | 0.80                |           |
| <b>Ball Nut Part Number</b>          | <b>8107-448-048</b> |           |
| <b>Flange Part Number</b>            | <b>N/A</b>          |           |
| <b>Wiper Kit Part Number</b>         | <b>N/A</b>          |           |

Note: Dimensional information for all End Journals and Bearing Supports is available on page 154. Information on required lubrication is on page 233.

# 0.750 x 0.500

## Precision Rolled Ball Screws — Inch Series

|                                    |               |
|------------------------------------|---------------|
| <b>Diameter x Lead (in.)</b>       | 0.750 x 0.500 |
| <b>Lead Accuracy (in/ft)</b>       | ± 0.004       |
| <b>Screw Weight (lbs/ft)</b>       | 1.4           |
| <b>Screw Root Diameter (in.)</b>   | 0.63          |
| <b>Nominal Ball Diameter (in.)</b> | 0.156         |
| <b>Number of Starts</b>            | 2             |

### Preloaded, Double Circuit, Round Ball Nut with Load Lock (1.250 - 16 V-Thread)

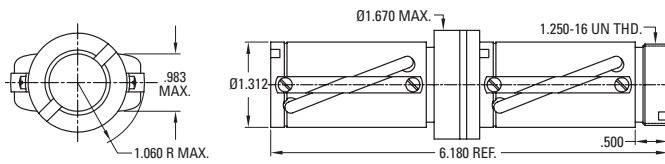

**p145** Quick Install Assembly

### Wiper and Flange Kits

#### Wiper

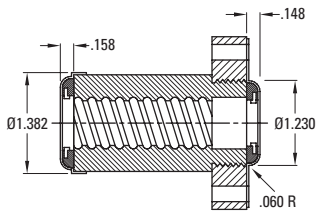

#### Flange

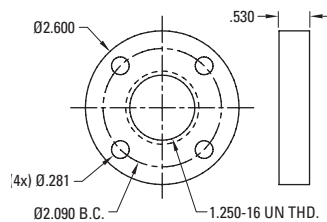

### Ball Screw Part Numbers

|                         |                 |             |
|-------------------------|-----------------|-------------|
| <b>Thread Direction</b> | Right Hand      | Left Hand   |
| <b>Screw Material</b>   | Alloy Steel     | Alloy Steel |
| <b>Standard Length</b>  | 72"             |             |
| <b>Maximum Length</b>   | 144"            |             |
| <b>Part Number</b>      | <b>190-9100</b> |             |

Ball screws can be cut to the length you require. Specify ball screw part number and overall length at time of order.

|                                      |                     |           |
|--------------------------------------|---------------------|-----------|
| <b>Thread Direction</b>              | Right Hand          | Left Hand |
| <b>Nut Material</b>                  | Alloy Steel         |           |
| <b>Dynamic Load (lbs)</b>            | 3,450               |           |
| <b>Max. Static Load (lbs)</b>        | 24,200              |           |
| <b>Torque to raise 1 lb (oz-in.)</b> | 1.42                |           |
| <b>Nut weight (lbs)</b>              | 1.85                |           |
| <b>Ball Nut Part Number</b>          | <b>8107-448-011</b> |           |
| <b>Flange Part Number</b>            | <b>8107-448-002</b> |           |
| <b>Wiper Kit Part Number</b>         | <b>8107-101-002</b> |           |

|                           |                     |  |
|---------------------------|---------------------|--|
| <b>Wiper Part Number</b>  | <b>8107-101-002</b> |  |
| <b>Flange Part Number</b> | <b>8107-448-002</b> |  |

Note: Dimensional information for all End Journals and Bearing Supports is available on page 154. Information on required lubrication is on page 233.

# 0.875 x 0.200

# Precision Rolled Ball Screws — Inch Series

|                             |               |
|-----------------------------|---------------|
| Diameter x Lead (in.)       | 0.875 x 0.200 |
| Lead Accuracy (in/ft)       | ± 0.004       |
| Screw Weight (lbs/ft)       | 1.8           |
| Screw Root Diameter (in.)   | 0.74          |
| Nominal Ball Diameter (in.) | 0.125         |
| Number of Starts            | 1             |

## Ball Screw Part Numbers

|                  |                |             |                 |
|------------------|----------------|-------------|-----------------|
| Thread Direction | Right Hand     | Left Hand   | Right Hand      |
| Screw Material   | Alloy Steel    | Alloy Steel | Stainless Steel |
| Standard Length  | 144"           |             |                 |
| Maximum Length   | 144"           |             |                 |
| Part Number      | <b>5708859</b> |             |                 |

Ball screws can be cut to the length you require. Specify ball screw part number and overall length at time of order.

## Double Circuit, Round Ball Nut

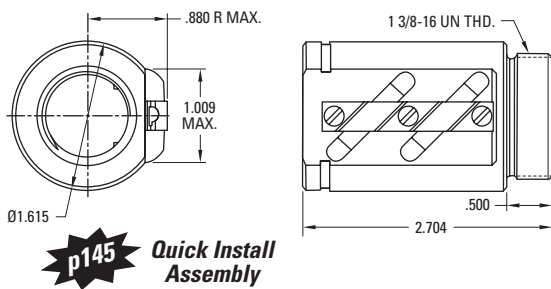

|                               |                |           |
|-------------------------------|----------------|-----------|
| Thread Direction              | Right Hand     | Left Hand |
| Nut Material                  | Alloy Steel    |           |
| Dynamic Load (lbs)            | 1,942          |           |
| Max. Static Load (lbs)        | 18,063         |           |
| Torque to raise 1 lb (oz-in.) | 0.57           |           |
| Nut weight (lbs)              | 0.69           |           |
| Ball Nut Part Number          | <b>5708277</b> |           |
| Flange Part Number            | <b>5708281</b> |           |
| Wiper Kit Part Number         | <b>7831512</b> |           |

## Preloaded, Single Circuit, Round Ball Nut with Integral Flange

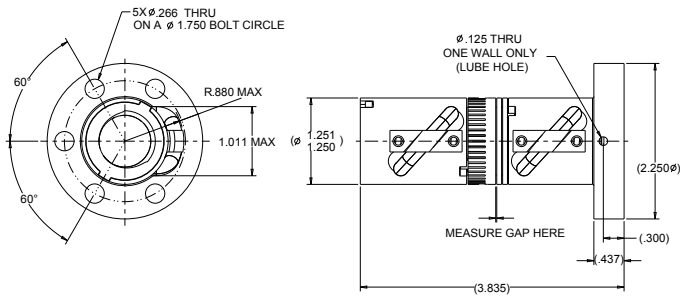

|                               |                 |
|-------------------------------|-----------------|
| Thread Direction              | Right Hand      |
| Nut Material                  | Alloy Steel     |
| Dynamic Load (lbs)            | 971             |
| Max. Static Load (lbs)        | 9,482           |
| Torque to raise 1 lb (oz-in.) | 0.57            |
| Nut weight (lbs)              | 1.81            |
| Ball Nut Part Number          | <b>7833677</b>  |
| Flange Part Number            | <b>Integral</b> |
| Wiper Kit Part Number         | <b>Integral</b> |

## Wiper and Flange Kits

### Wiper

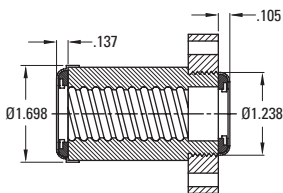

### Flange

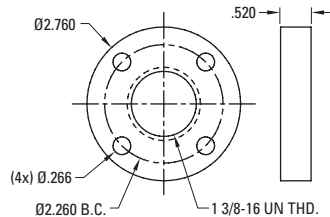

Note: Wiper kit does not include flange end cap.

|                    |                |  |
|--------------------|----------------|--|
| Wiper Part Number  | <b>7831512</b> |  |
| Flange Part Number | <b>5708281</b> |  |

Note: Dimensional information for all End Journals and Bearing Supports is available on page 154. Information on required lubrication is on page 233.



**1.000 x 0.250**

**Precision Rolled Ball Screws — Inch Series**

|                                    |               |
|------------------------------------|---------------|
| <b>Diameter x Lead (in.)</b>       | 1.000 x 0.250 |
| <b>Lead Accuracy (in/ft)</b>       | ± 0.004       |
| <b>Screw Weight (lbs/ft)</b>       | 2.3           |
| <b>Screw Root Diameter (in.)</b>   | 0.84          |
| <b>Nominal Ball Diameter (in.)</b> | 0.156         |
| <b>Number of Starts</b>            | 1             |

**Single Circuit, Square Ball Nut with Load Lock**

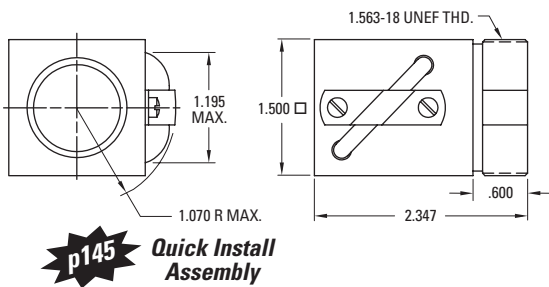

**Single Circuit, Round Ball Nut with Load Lock**

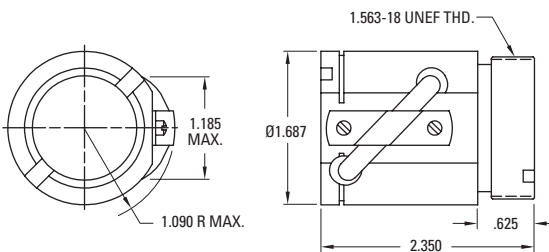

**Double Circuit, Square Ball Nut with Load Lock**

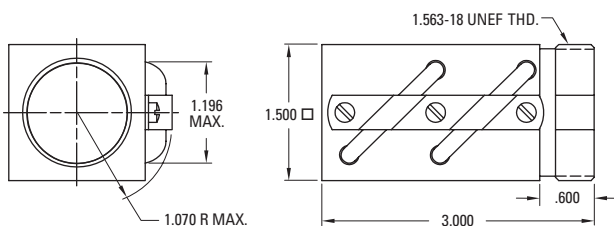

**Ball Screw Part Numbers**

| Thread Direction       | Right Hand      | Left Hand       | Right Hand      |
|------------------------|-----------------|-----------------|-----------------|
| <b>Screw Material</b>  | Alloy Steel     | Alloy Steel     | Stainless Steel |
| <b>Standard Length</b> | 144"            | 144"            |                 |
| <b>Maximum Length</b>  | 288"            | 144"            |                 |
| <b>Part Number</b>     | <b>190-9104</b> | <b>190-9105</b> |                 |

Ball screws can be cut to the length you require. Specify ball screw part number and overall length at time of order.

| Thread Direction                     | Right Hand          | Left Hand           |
|--------------------------------------|---------------------|---------------------|
| <b>Nut Material</b>                  | Alloy Steel         | Alloy Steel         |
| <b>Dynamic Load (lbs)</b>            | 1,612               | 1,612               |
| <b>Max. Static Load (lbs)</b>        | 15,300              | 15,300              |
| <b>Torque to raise 1 lb (oz-in.)</b> | 0.71                | 0.71                |
| <b>Nut weight (lbs)</b>              | 0.81                | 0.81                |
| <b>Ball Nut Part Number</b>          | <b>8110-448-055</b> | <b>8110-448-091</b> |
| <b>Flange Part Number</b>            | <b>8110-448-002</b> | <b>8110-448-002</b> |
| <b>Wiper Kit Part Number</b>         | <b>N/A</b>          | <b>N/A</b>          |

| Thread Direction                     | Right Hand          | Left Hand                         |
|--------------------------------------|---------------------|-----------------------------------|
| <b>Nut Material</b>                  | Alloy Steel         | Alloy Steel                       |
| <b>Dynamic Load (lbs)</b>            | 1,612               | 1,612                             |
| <b>Max. Static Load (lbs)</b>        | 13,913              | 13,913                            |
| <b>Torque to raise 1 lb (oz-in.)</b> | 0.71                | 0.71                              |
| <b>Nut weight (lbs)</b>              | 0.81                | 0.81                              |
| <b>Ball Nut Part Number</b>          | <b>8110-448-032</b> | <b>8110-448-030<sup>(1)</sup></b> |
| <b>Flange Part Number</b>            | <b>8110-448-002</b> | <b>8110-448-002</b>               |
| <b>Wiper Kit Part Number</b>         | <b>8110-101-002</b> | <b>8110-101-002</b>               |

(1) Load Lock not available

| Thread Direction                     | Right Hand          | Left Hand |
|--------------------------------------|---------------------|-----------|
| <b>Nut Material</b>                  | Alloy Steel         |           |
| <b>Dynamic Load (lbs)</b>            | 3,350               |           |
| <b>Max. Static Load (lbs)</b>        | 30,750              |           |
| <b>Torque to raise 1 lb (oz-in.)</b> | 0.71                |           |
| <b>Nut weight (lbs)</b>              | 1.25                |           |
| <b>Ball Nut Part Number</b>          | <b>8110-448-056</b> |           |
| <b>Flange Part Number</b>            | <b>8110-448-002</b> |           |
| <b>Wiper Kit Part Number</b>         | <b>N/A</b>          |           |

Note: Dimensional information for all End Journals and Bearing Supports is available on page 154. Information on required lubrication is on page 233.

# 1.000 x 0.250

## Precision Rolled Ball Screws — Inch Series

|                             |               |
|-----------------------------|---------------|
| Diameter x Lead (in.)       | 1.000 x 0.250 |
| Lead Accuracy (in/ft)       | ± 0.004       |
| Screw Weight (lbs/ft)       | 2.3           |
| Screw Root Diameter (in.)   | 0.84          |
| Nominal Ball Diameter (in.) | 0.156         |
| Number of Starts            | 1             |

### Ball Screw Part Numbers

| Thread Direction | Right Hand      | Left Hand       | Right Hand      |
|------------------|-----------------|-----------------|-----------------|
| Screw Material   | Alloy Steel     | Alloy Steel     | Stainless Steel |
| Standard Length  | 144"            | 144"            |                 |
| Maximum Length   | 288"            | 144"            |                 |
| Part Number      | <b>190-9104</b> | <b>190-9105</b> |                 |

Ball screws can be cut to the length you require. Specify ball screw part number and overall length at time of order.

### Double Circuit, Round Ball Nut with Load Lock

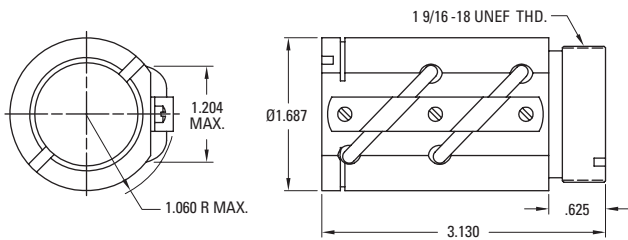

| Thread Direction              | Right Hand          | Left Hand           |
|-------------------------------|---------------------|---------------------|
| Nut Material                  | Alloy Steel         | Alloy Steel         |
| Dynamic Load (lbs)            | 3,350               | 3,350               |
| Max. Static Load (lbs)        | 30,750              | 30,750              |
| Torque to raise 1 lb (oz-in.) | 0.71                | 0.71                |
| Nut weight (lbs)              | 1.25                | 1.25                |
| Ball Nut Part Number          | <b>8110-448-026</b> | <b>8110-448-024</b> |
| Flange Part Number            | <b>8110-448-002</b> | <b>8110-448-002</b> |
| Wiper Kit Part Number         | <b>8110-101-002</b> | <b>8110-101-002</b> |

### Double Circuit, Round Ball Nut with Integral Flange

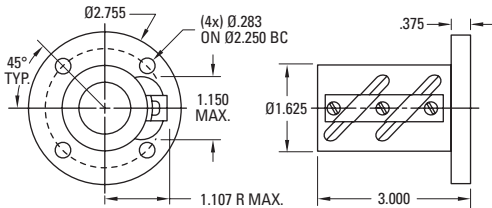

| Thread Direction              | Right Hand          | Left Hand           |
|-------------------------------|---------------------|---------------------|
| Nut Material                  | Alloy Steel         | Alloy Steel         |
| Dynamic Load (lbs)            | 3,350               | 3,350               |
| Max. Static Load (lbs)        | 30,750              | 30,750              |
| Torque to raise 1 lb (oz-in.) | 0.71                | 0.71                |
| Nut weight (lbs)              | 1.50                | 1.50                |
| Ball Nut Part Number          | <b>8110-448-087</b> | <b>8110-448-088</b> |
| Flange Part Number            | <b>Integral</b>     | <b>Integral</b>     |
| Wiper Kit Part Number         | <b>N/A</b>          | <b>N/A</b>          |

### Wiper and Flange Kits

#### Wiper

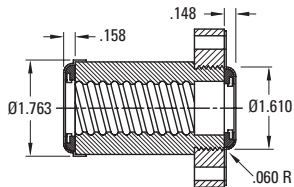

#### Flange

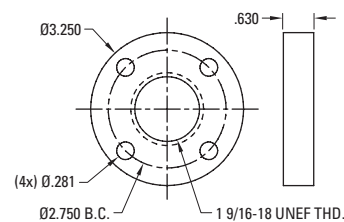

|                    |                     |  |
|--------------------|---------------------|--|
| Wiper Part Number  | <b>8110-101-002</b> |  |
| Flange Part Number | <b>8110-448-002</b> |  |

Note: Dimensional information for all End Journals and Bearing Supports is available on page 154. Information on required lubrication is on page 233.

# 1.000 x 0.250

## Precision Rolled Ball Screws — Inch Series

|                             |               |
|-----------------------------|---------------|
| Diameter x Lead (in.)       | 1.000 x 0.250 |
| Lead Accuracy (in/ft)       | ± 0.004       |
| Screw Weight (lbs/ft)       | 2.3           |
| Screw Root Diameter (in.)   | 0.84          |
| Nominal Ball Diameter (in.) | 0.156         |
| Number of Starts            | 1             |

### Preloaded, Single Circuit, Round Ball Nut with Integral Flange

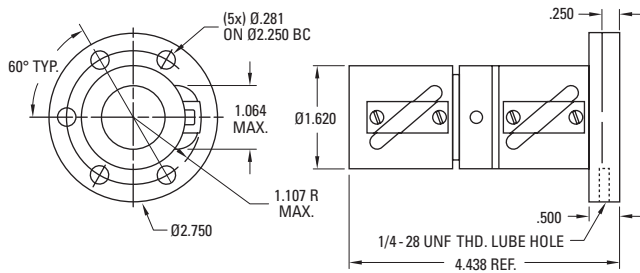

### Preloaded, Single Circuit, Square Ball Nut

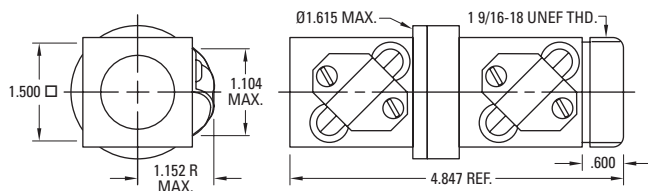

**p145** Quick Install Assembly

### Wiper and Flange Kits

#### Wiper

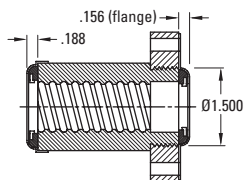

#### Flange

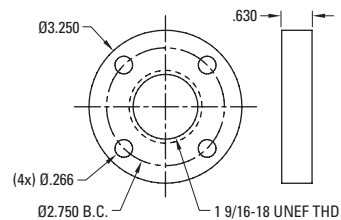

Note: Wiper Kit does not include flange end cap.

### Ball Screw Part Numbers

| Thread Direction | Right Hand     | Left Hand      | Right Hand      |
|------------------|----------------|----------------|-----------------|
| Screw Material   | Alloy Steel    | Alloy Steel    | Stainless Steel |
| Standard Length  | 192"           | 192"           |                 |
| Maximum Length   | 192"           | 192"           |                 |
| Part Number      | <b>7820426</b> | <b>7820428</b> |                 |

Ball screws can be cut to the length you require. Specify ball screw part number and overall length at time of order.

| Thread Direction              | Right Hand      | Left Hand |
|-------------------------------|-----------------|-----------|
| Nut Material                  | Alloy Steel     |           |
| Dynamic Load (lbs)            | 1,612           |           |
| Max. Static Load (lbs)        | 13,913          |           |
| Torque to raise 1 lb (oz-in.) | 0.71            |           |
| Nut weight (lbs)              | 2.00            |           |
| Ball Nut Part Number          | <b>7823586</b>  |           |
| Flange Part Number            | <b>Internal</b> |           |
| Wiper Kit Part Number         | <b>Internal</b> |           |

| Thread Direction              | Right Hand     | Left Hand      |
|-------------------------------|----------------|----------------|
| Nut Material                  | Alloy Steel    | Alloy Steel    |
| Dynamic Load (lbs)            | 1,612          | 1,612          |
| Max. Static Load (lbs)        | 13,913         | 13,913         |
| Torque to raise 1 lb (oz-in.) | 0.71           | 0.71           |
| Nut weight (lbs)              | 1.90           | 1.90           |
| Ball Nut Part Number          | <b>5704167</b> | <b>5704168</b> |
| Flange Part Number            | <b>5707571</b> | <b>5707571</b> |
| Wiper Kit Part Number         | <b>5702649</b> | <b>5702649</b> |

|                    |                |  |
|--------------------|----------------|--|
| Wiper Part Number  | <b>5702649</b> |  |
| Flange Part Number | <b>5707571</b> |  |

Note: Dimensional information for all End Journals and Bearing Supports is available on page 154. Information on required lubrication is on page 233.

# 1.000 x 0.500

## Precision Rolled Ball Screws — Inch Series

|                             |               |
|-----------------------------|---------------|
| Diameter x Lead (in.)       | 1.000 x 0.500 |
| Lead Accuracy (in/ft)       | ± 0.004       |
| Screw Weight (lbs/ft)       | 2.6           |
| Screw Root Diameter (in.)   | 0.88          |
| Nominal Ball Diameter (in.) | 0.156         |
| Number of Starts            | 2             |

### Double Circuit, Round Ball Nut with Load Lock

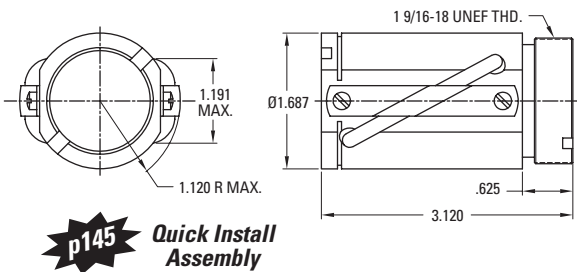

### Preloaded, Double Circuit, Round Ball Nut with Load Lock

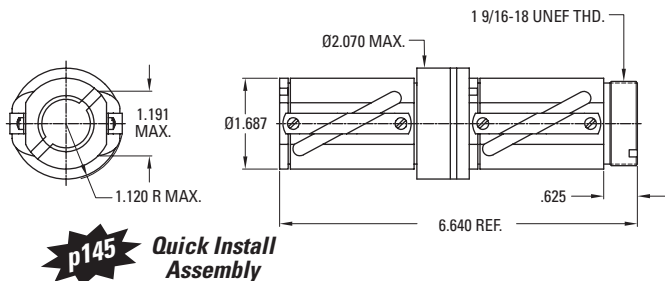

### Wiper and Flange Kits

#### Wiper

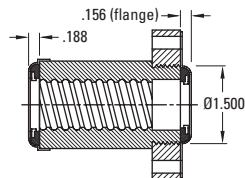

#### Flange

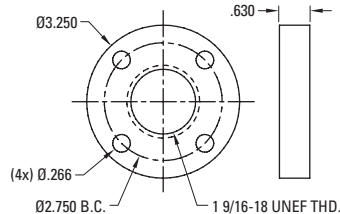

### Ball Screw Part Numbers

|                  |                 |             |                 |
|------------------|-----------------|-------------|-----------------|
| Thread Direction | Right Hand      | Left Hand   | Right Hand      |
| Screw Material   | Alloy Steel     | Alloy Steel | Stainless Steel |
| Standard Length  | 144"            |             |                 |
| Maximum Length   | 288"            |             |                 |
| Part Number      | <b>190-9103</b> |             |                 |

Ball screws can be cut to the length you require. Specify ball screw part number and overall length at time of order.

|                               |                     |           |
|-------------------------------|---------------------|-----------|
| Thread Direction              | Right Hand          | Left Hand |
| Nut Material                  | Alloy Steel         |           |
| Dynamic Load (lbs)            | 3,950               |           |
| Max. Static Load (lbs)        | 32,300              |           |
| Torque to raise 1 lb (oz-in.) | 1.42                |           |
| Nut weight (lbs)              | 1.25                |           |
| Ball Nut Part Number          | <b>8110-448-022</b> |           |
| Flange Part Number            | <b>8110-448-002</b> |           |
| Wiper Kit Part Number         | <b>8110-101-002</b> |           |

|                               |                     |           |
|-------------------------------|---------------------|-----------|
| Thread Direction              | Right Hand          | Left Hand |
| Nut Material                  | Alloy Steel         |           |
| Dynamic Load (lbs)            | 3,950               |           |
| Max. Static Load (lbs)        | 32,300              |           |
| Torque to raise 1 lb (oz-in.) | 1.42                |           |
| Nut weight (lbs)              | 2.90                |           |
| Ball Nut Part Number          | <b>8110-448-016</b> |           |
| Flange Part Number            | <b>8110-448-002</b> |           |
| Wiper Kit Part Number         | <b>8110-101-002</b> |           |

|                    |                     |  |
|--------------------|---------------------|--|
| Wiper Part Number  | <b>8110-101-002</b> |  |
| Flange Part Number | <b>8110-448-002</b> |  |

Note: Dimensional information for all End Journals and Bearing Supports is available on page 154. Information on required lubrication is on page 233.

**1.000 x 1.000**

**Precision Rolled Ball Screws — Inch Series**

|                             |               |
|-----------------------------|---------------|
| Diameter x Lead (in.)       | 1.000 x 1.000 |
| Lead Accuracy (in/ft)       | ± 0.004       |
| Screw Weight (lbs/ft)       | 2.3           |
| Screw Root Diameter (in.)   | 0.84          |
| Nominal Ball Diameter (in.) | 0.156         |
| Number of Starts            | 4             |

**Double Circuit, Round Ball Nut with Load Lock**

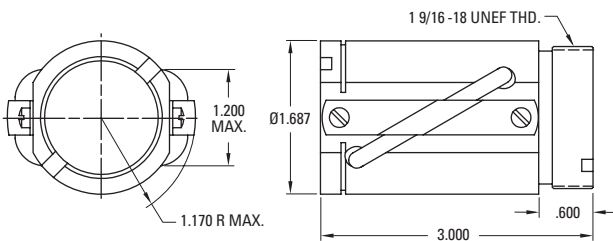

**Double Circuit, Square Ball Nut with Load Lock**

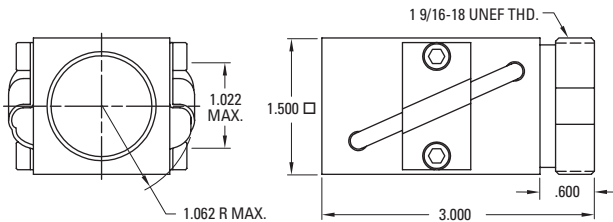

**p145 Quick Install Assembly**

**Wiper and Flange Kits**

**Wiper**

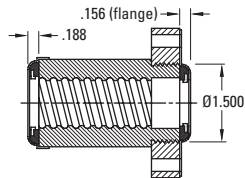

**Flange**

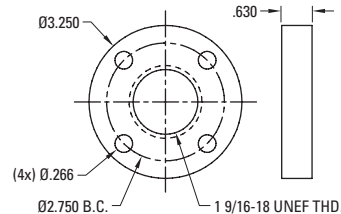

**Ball Screw Part Numbers**

|                  |                 |             |                 |
|------------------|-----------------|-------------|-----------------|
| Thread Direction | Right Hand      | Left Hand   | Right Hand      |
| Screw Material   | Alloy Steel     | Alloy Steel | Stainless Steel |
| Standard Length  | 144"            |             | 144"            |
| Maximum Length   | 288"            |             | 144"            |
| Part Number      | <b>190-9102</b> |             | <b>190-9150</b> |

Ball screws can be cut to the length you require. Specify ball screw part number and overall length at time of order.

|                               |                     |             |                                   |
|-------------------------------|---------------------|-------------|-----------------------------------|
| Thread Direction              | Right Hand          | Left Hand   | Right Hand                        |
| Nut Material                  | Alloy Steel         | Alloy Steel | Stainless Steel                   |
| Dynamic Load (lbs)            | 2,250               |             | 430                               |
| Max. Static Load (lbs)        | 13,750              |             | 2000                              |
| Torque to raise 1 lb (oz-in.) | 2.83                |             | 2.83                              |
| Nut weight (lbs)              | 1.25                |             | 1.25                              |
| Ball Nut Part Number          | <b>8110-448-020</b> |             | <b>8110-448-034<sup>(1)</sup></b> |
| Flange Part Number            | <b>8110-448-002</b> |             | <b>8110-448-037</b>               |
| Wiper Kit Part Number         | <b>8110-101-002</b> |             | <b>8110-101-002</b>               |

(1) Load Lock not available

|                               |                     |           |
|-------------------------------|---------------------|-----------|
| Thread Direction              | Right Hand          | Left Hand |
| Nut Material                  | Alloy Steel         |           |
| Dynamic Load (lbs)            | 2,400               |           |
| Max. Static Load (lbs)        | 13,600              |           |
| Torque to raise 1 lb (oz-in.) | 2.83                |           |
| Nut weight (lbs)              | 1.25                |           |
| Ball Nut Part Number          | <b>8110-448-086</b> |           |
| Flange Part Number            | <b>8110-448-002</b> |           |
| Wiper Kit Part Number         | <b>N/A</b>          |           |

|                    |                     |  |
|--------------------|---------------------|--|
| Wiper Part Number  | <b>8110-101-002</b> |  |
| Flange Part Number | <b>8110-448-002</b> |  |
| Flange Part Number | <b>8110-448-037</b> |  |

Note: Dimensional information for all End Journals and Bearing Supports is available on page 154. Information on required lubrication is on page 233.



# 1.150 x 0.200

## Precision Rolled Ball Screws — Inch Series

|                             |               |
|-----------------------------|---------------|
| Diameter x Lead (in.)       | 1.150 x 0.200 |
| Lead Accuracy (in/ft)       | ± 0.004       |
| Screw Weight (lbs/ft)       | 3.2           |
| Screw Root Diameter (in.)   | 1.02          |
| Nominal Ball Diameter (in.) | 0.125         |
| Number of Starts            | 1             |

### Ball Screw Part Numbers

|                  |                 |             |                 |
|------------------|-----------------|-------------|-----------------|
| Thread Direction | Right Hand      | Left Hand   | Right Hand      |
| Screw Material   | Alloy Steel     | Alloy Steel | Stainless Steel |
| Standard Length  | 144"            |             |                 |
| Maximum Length   | 288"            |             |                 |
| Part Number      | <b>190-9106</b> |             |                 |

Ball screws can be cut to the length you require. Specify ball screw part number and overall length at time of order.

### Preloaded, Double Circuit, Round Ball Nut with Load Lock

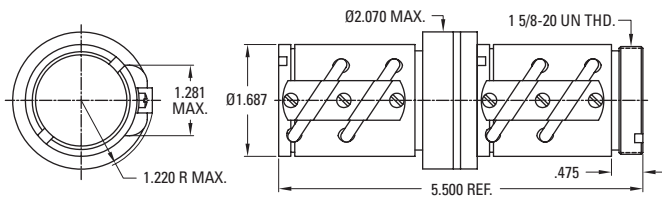

**p145** Quick Install Assembly

|                               |                     |           |
|-------------------------------|---------------------|-----------|
| Thread Direction              | Right Hand          | Left Hand |
| Nut Material                  | Alloy Steel         |           |
| Dynamic Load (lbs)            | 2,400               |           |
| Max. Static Load (lbs)        | 27,550              |           |
| Torque to raise 1 lb (oz-in.) | 0.57                |           |
| Nut weight (lbs)              | 2.25                |           |
| Ball Nut Part Number          | <b>8111-448-004</b> |           |
| Flange Part Number            | <b>8111-448-002</b> |           |
| Wiper Kit Part Number         | <b>8111-101-002</b> |           |

### Double Circuit, Round Ball Nut with Load Lock

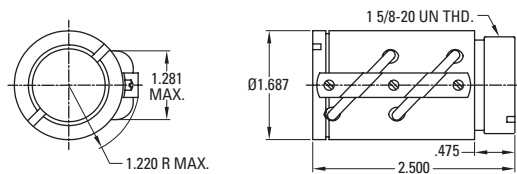

**p145** Quick Install Assembly

|                               |                     |           |
|-------------------------------|---------------------|-----------|
| Thread Direction              | Right Hand          | Left Hand |
| Nut Material                  | Alloy Steel         |           |
| Dynamic Load (lbs)            | 2,400               |           |
| Max. Static Load (lbs)        | 27,550              |           |
| Torque to raise 1 lb (oz-in.) | 0.57                |           |
| Nut weight (lbs)              | 0.88                |           |
| Ball Nut Part Number          | <b>8111-448-006</b> |           |
| Flange Part Number            | <b>8111-448-002</b> |           |
| Wiper Kit Part Number         | <b>8111-101-002</b> |           |

### Wiper and Flange Kits

#### Wiper

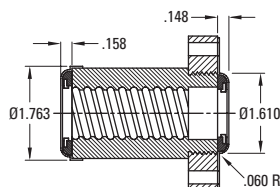

#### Flange

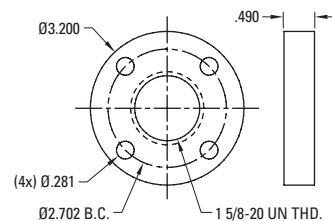

|                    |                     |  |
|--------------------|---------------------|--|
| Wiper Part Number  | <b>8111-101-002</b> |  |
| Flange Part Number | <b>8111-448-002</b> |  |

Note: Dimensional information for all End Journals and Bearing Supports is available on page 154. Information on required lubrication is on page 233.

# 1.171 x 0.413

## Precision Rolled Ball Screws — Inch Series

|                                    |               |
|------------------------------------|---------------|
| <b>Diameter x Lead (in.)</b>       | 1.171 x 0.413 |
| <b>Lead Accuracy (in/ft)</b>       | ± 0.004       |
| <b>Screw Weight (lbs/ft)</b>       | 2.8           |
| <b>Screw Root Diameter (in.)</b>   | 0.87          |
| <b>Nominal Ball Diameter (in.)</b> | 0.281         |
| <b>Number of Starts</b>            | 1             |

### Double Circuit, Round Ball Nut

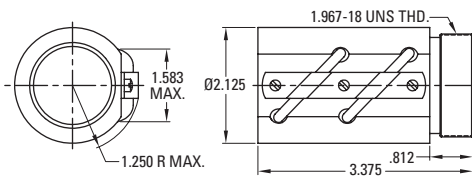

### Ball Screw Part Numbers

|                         |                |             |                 |
|-------------------------|----------------|-------------|-----------------|
| <b>Thread Direction</b> | Right Hand     | Left Hand   | Right Hand      |
| <b>Screw Material</b>   | Alloy Steel    | Alloy Steel | Stainless Steel |
| <b>Standard Length</b>  | 192"           |             |                 |
| <b>Maximum Length</b>   | 192"           |             |                 |
| <b>Part Number</b>      | <b>7820432</b> |             |                 |

Ball screws can be cut to the length you require. Specify ball screw part number and overall length at time of order.

|                                      |                |           |
|--------------------------------------|----------------|-----------|
| <b>Thread Direction</b>              | Right Hand     | Left Hand |
| <b>Nut Material</b>                  | Alloy Steel    |           |
| <b>Dynamic Load (lbs)</b>            | 3,894          |           |
| <b>Max. Static Load (lbs)</b>        | 22,917         |           |
| <b>Torque to raise 1 lb (oz-in.)</b> | 1.17           |           |
| <b>Nut weight (lbs)</b>              | 1.94           |           |
| <b>Ball Nut Part Number</b>          | <b>5707511</b> |           |
| <b>Flange Part Number</b>            | <b>5707572</b> |           |
| <b>Wiper Kit Part Number</b>         | <b>5702653</b> |           |

### Wiper and Flange Kits

#### Wiper

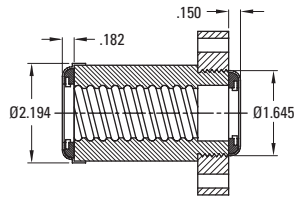

#### Flange

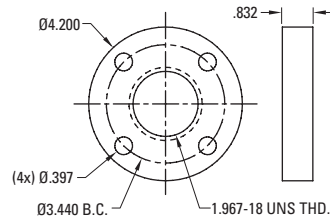

Note: Wiper kit does not include flange end cap.

|                           |                |  |
|---------------------------|----------------|--|
| <b>Wiper Part Number</b>  | <b>5702653</b> |  |
| <b>Flange Part Number</b> | <b>5707572</b> |  |

Note: Dimensional information for all End Journals and Bearing Supports is available on page 154. Information on required lubrication is on page 233.



# 1.500 x 0.250

## Precision Rolled Ball Screws — Inch Series

|                             |               |
|-----------------------------|---------------|
| Diameter x Lead (in.)       | 1.500 x 0.250 |
| Lead Accuracy (in/ft)       | ± 0.004       |
| Screw Weight (lbs/ft)       | 5.2           |
| Screw Root Diameter (in.)   | 1.32          |
| Nominal Ball Diameter (in.) | 0.156         |
| Number of Starts            | 1             |

### Ball Screw Part Numbers

| Thread Direction | Right Hand     | Left Hand      | Right Hand      |
|------------------|----------------|----------------|-----------------|
| Screw Material   | Alloy Steel    | Alloy Steel    | Stainless Steel |
| Standard Length  | 240"           | 240"           |                 |
| Maximum Length   | 240"           | 240"           |                 |
| Part Number      | <b>7820595</b> | <b>7820596</b> |                 |

Ball screws can be cut to the length you require. Specify ball screw part number and overall length at time of order.

### Double Circuit, Round Ball Nut with Load Lock

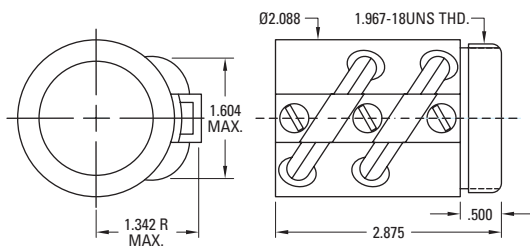

**p145** Quick Install Assembly

### Preloaded, Double Circuit, Round Ball Nut with Load Lock

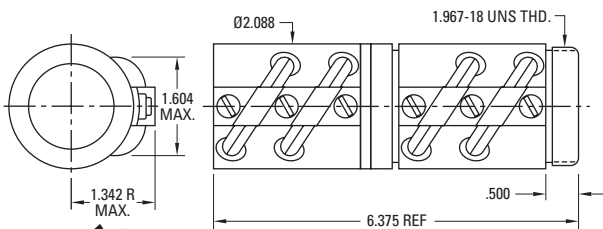

**p145** Quick Install Assembly

| Thread Direction              | Right Hand     | Left Hand (1)                |
|-------------------------------|----------------|------------------------------|
| Nut Material                  | Alloy Steel    | Alloy Steel                  |
| Dynamic Load (lbs)            | 4,198          | 4,198                        |
| Max. Static Load (lbs)        | 44,030         | 44,030                       |
| Torque to raise 1 lb (oz-in.) | 0.71           | 0.71                         |
| Nut weight (lbs)              | 1.65           | 1.65                         |
| Ball Nut Part Number          | <b>7833233</b> | <b>5701990<sup>(1)</sup></b> |
| Flange Part Number            | <b>5706754</b> | <b>5706754</b>               |
| Wiper Kit Part Number         | <b>5702654</b> | <b>5702654</b>               |

(1) Load Lock not available

| Thread Direction              | Right Hand     | Left Hand                    |
|-------------------------------|----------------|------------------------------|
| Nut Material                  | Alloy Steel    | Alloy Steel                  |
| Dynamic Load (lbs)            | 4,198          | 4,198                        |
| Max. Static Load (lbs)        | 44,030         | 44,030                       |
| Torque to raise 1 lb (oz-in.) | 0.71           | 0.71                         |
| Nut weight (lbs)              | 3.80           | 3.80                         |
| Ball Nut Part Number          | <b>7833234</b> | <b>5704573<sup>(1)</sup></b> |
| Flange Part Number            | <b>5706754</b> | <b>5706754</b>               |
| Wiper Kit Part Number         | <b>5702654</b> | <b>5702654</b>               |

(1) Load Lock not available

### Wiper and Flange Kits

#### Wiper

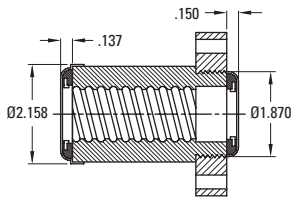

#### Flange

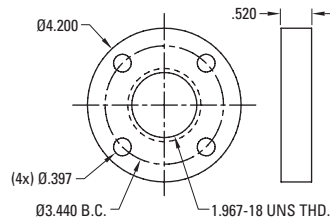

Note: Wiper kit does not include flange end cap.

|                    |                |  |
|--------------------|----------------|--|
| Wiper Part Number  | <b>5702654</b> |  |
| Flange Part Number | <b>5706754</b> |  |

Note: Dimensional information for all End Journals and Bearing Supports is available on page 154. Information on required lubrication is on page 233.

# 1.500 x 0.473

## Precision Rolled Ball Screws — Inch Series

|                                    |               |
|------------------------------------|---------------|
| <b>Diameter x Lead (in.)</b>       | 1.500 x 0.473 |
| <b>Lead Accuracy (in/ft)</b>       | ± 0.004       |
| <b>Screw Weight (lbs/ft)</b>       | 4.5           |
| <b>Screw Root Diameter (in.)</b>   | 1.14          |
| <b>Nominal Ball Diameter (in.)</b> | 0.344         |
| <b>Number of Starts</b>            | 1             |

### Ball Screw Part Numbers

|                         |                |             |                 |
|-------------------------|----------------|-------------|-----------------|
| <b>Thread Direction</b> | Right Hand     | Left Hand   | Right Hand      |
| <b>Screw Material</b>   | Alloy Steel    | Alloy Steel | Stainless Steel |
| <b>Standard Length</b>  | 240"           |             |                 |
| <b>Maximum Length</b>   | 240"           |             |                 |
| <b>Part Number</b>      | <b>7820597</b> |             |                 |

Ball screws can be cut to the length you require. Specify ball screw part number and overall length at time of order.

### Double Circuit, Round Ball Nut

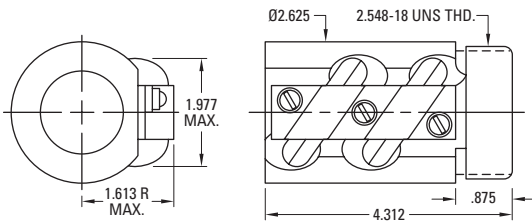

**p145** Quick Install Assembly

|                                      |                |           |
|--------------------------------------|----------------|-----------|
| <b>Thread Direction</b>              | Right Hand     | Left Hand |
| <b>Nut Material</b>                  | Alloy Steel    |           |
| <b>Dynamic Load (lbs)</b>            | 10,050         |           |
| <b>Max. Static Load (lbs)</b>        | 57,770         |           |
| <b>Torque to raise 1 lb (oz-in.)</b> | 1.34           |           |
| <b>Nut weight (lbs)</b>              | 3.94           |           |
| <b>Ball Nut Part Number</b>          | <b>5707513</b> |           |
| <b>Flange Part Number</b>            | <b>5707573</b> |           |
| <b>Wiper Kit Part Number</b>         | <b>5702655</b> |           |

### Wiper and Flange Kits

#### Wiper

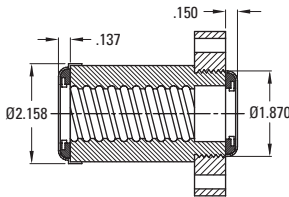

#### Flange

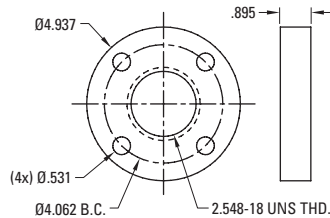

Note: Wiper kit does not include flange end cap.

|                           |                |  |
|---------------------------|----------------|--|
| <b>Wiper Part Number</b>  | <b>5702655</b> |  |
| <b>Flange Part Number</b> | <b>5707573</b> |  |

Note: Dimensional information for all End Journals and Bearing Supports is available on page 154. Information on required lubrication is on page 233.

# 1.500 x 0.500

## Precision Rolled Ball Screws — Inch Series

|                             |               |
|-----------------------------|---------------|
| Diameter x Lead (in.)       | 1.500 x 0.500 |
| Lead Accuracy (in/ft)       | ± 0.004       |
| Screw Weight (lbs/ft)       | 5.6           |
| Screw Root Diameter (in.)   | 1.27          |
| Nominal Ball Diameter (in.) | 0.312         |
| Number of Starts            | 1             |

### Ball Screw Part Numbers

|                  |                 |                 |                 |
|------------------|-----------------|-----------------|-----------------|
| Thread Direction | Right Hand      | Left Hand       | Right Hand      |
| Screw Material   | Alloy Steel     | Alloy Steel     | Stainless Steel |
| Standard Length  | 144"            | 144"            |                 |
| Maximum Length   | 288"            | 144"            |                 |
| Part Number      | <b>190-9108</b> | <b>190-9109</b> |                 |

Ball screws can be cut to the length you require. Specify ball screw part number and overall length at time of order.

### Double Circuit, Round Ball Nut with Load Lock

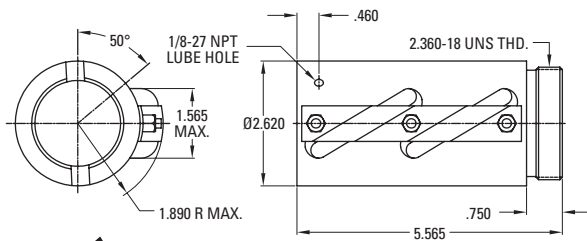

|                               |                     |                     |
|-------------------------------|---------------------|---------------------|
| Thread Direction              | Right Hand          | Left Hand           |
| Nut Material                  | Alloy Steel         | Alloy Steel         |
| Dynamic Load (lbs)            | 14,513              | 14,513              |
| Max. Static Load (lbs)        | 102,300             | 102,300             |
| Torque to raise 1 lb (oz-in.) | 1.42                | 1.42                |
| Nut weight (lbs)              | 5.70                | 5.70                |
| Ball Nut Part Number          | <b>8115-448-016</b> | <b>8115-448-018</b> |
| Flange Part Number            | <b>8115-448-004</b> | <b>8115-448-004</b> |
| Wiper Kit Part Number*        | Internal            | Internal            |

### Preloaded, Double Circuit, Round Ball Nut with Load Lock

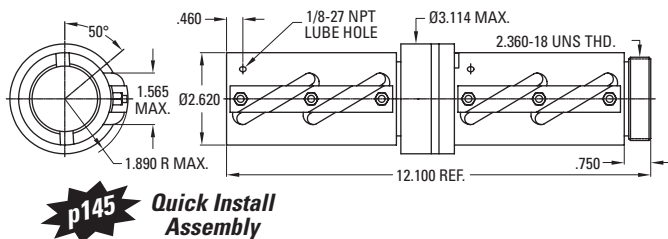

|                               |                     |           |
|-------------------------------|---------------------|-----------|
| Thread Direction              | Right Hand          | Left Hand |
| Nut Material                  | Alloy Steel         |           |
| Dynamic Load (lbs)            | 14,513              |           |
| Max. Static Load (lbs)        | 102,300             |           |
| Torque to raise 1 lb (oz-in.) | 1.42                |           |
| Nut weight (lbs)              | 12.20               |           |
| Ball Nut Part Number          | <b>8115-448-006</b> |           |
| Flange Part Number            | <b>8115-448-004</b> |           |
| Wiper Kit Part Number*        | Internal            |           |

### Flange Kit

#### Flange

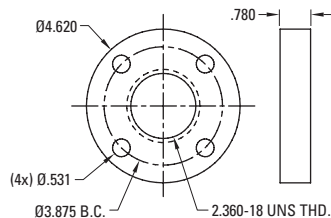

|                    |                     |
|--------------------|---------------------|
| Wiper Part Number  | <b>8115-101-004</b> |
| Flange Part Number | <b>8115-448-004</b> |

\* Wiper kit included with this ball nut.

Note: Dimensional information for all End Journals and Bearing Supports is available on page 154. Information on required lubrication is on page 233.

# 1.500 x 1.000

## Precision Rolled Ball Screws — Inch Series

|                             |               |
|-----------------------------|---------------|
| Diameter x Lead (in.)       | 1.500 x 1.000 |
| Lead Accuracy (in/ft)       | ± 0.004       |
| Screw Weight (lbs/ft)       | 5.6           |
| Screw Root Diameter (in.)   | 1.14          |
| Nominal Ball Diameter (in.) | 0.344         |
| Number of Starts            | 2             |

### Double Circuit, Square Ball Nut

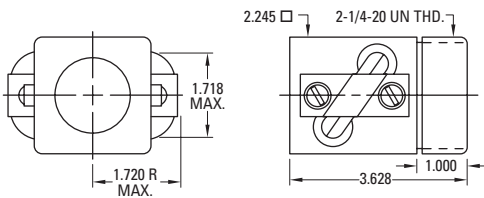

**p145** Quick Install Assembly

### Double Circuit, Square Ball Nut — High Speed

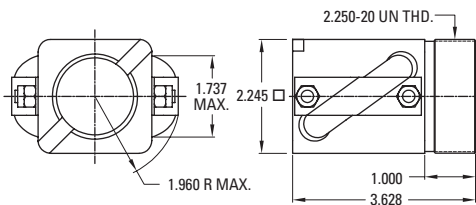

### Preloaded, Double Circuit, Square Ball Nut

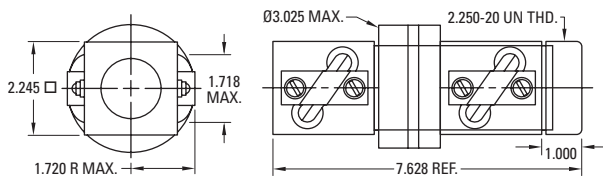

**p145** Quick Install Assembly

### Wiper and Flange Kits

#### Wiper

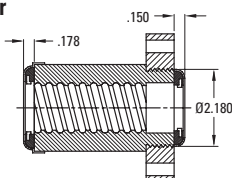

Note: Wiper kit does not include flange end cap.

#### Flange

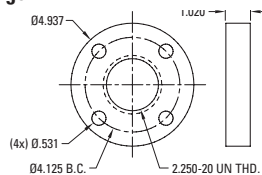

### Ball Screw Part Numbers

|                  |                |                |                 |
|------------------|----------------|----------------|-----------------|
| Thread Direction | Right Hand     | Left Hand      | Right Hand      |
| Screw Material   | Alloy Steel    | Alloy Steel    | Stainless Steel |
| Standard Length  | 144"           | 240"           |                 |
| Maximum Length   | 288"           | 240"           |                 |
| Part Number      | <b>7820598</b> | <b>7825925</b> |                 |

Ball screws can be cut to the length you require. Specify ball screw part number and overall length at time of order.

|                               |                |                |
|-------------------------------|----------------|----------------|
| Thread Direction              | Right Hand     | Left Hand      |
| Nut Material                  | Alloy Steel    | Alloy Steel    |
| Dynamic Load (lbs)            | 8,250          | 8,250          |
| Max. Static Load (lbs)        | 34,662         | 34,662         |
| Torque to raise 1 lb (oz-in.) | 2.83           | 2.83           |
| Nut weight (lbs)              | 3.88           | 3.88           |
| Ball Nut Part Number          | <b>5708280</b> | <b>5701995</b> |
| Flange Part Number            | <b>5707777</b> | <b>5707777</b> |
| Wiper Kit Part Number         | <b>5702657</b> | <b>5702657</b> |

|                               |                |           |
|-------------------------------|----------------|-----------|
| Thread Direction              | Right Hand     | Left Hand |
| Nut Material                  | Alloy Steel    |           |
| Dynamic Load (lbs)            | 8,250          |           |
| Max. Static Load (lbs)        | 34,662         |           |
| Torque to raise 1 lb (oz-in.) | 2.83           |           |
| Nut weight (lbs)              | 3.88           |           |
| Ball Nut Part Number          | <b>7833724</b> |           |
| Flange Part Number            | <b>5707777</b> |           |
| Wiper Kit Part Number         | <b>5702657</b> |           |

|                               |                |           |
|-------------------------------|----------------|-----------|
| Thread Direction              | Right Hand     | Left Hand |
| Nut Material                  | Alloy Steel    |           |
| Dynamic Load (lbs)            | 8,250          |           |
| Max. Static Load (lbs)        | 34,662         |           |
| Torque to raise 1 lb (oz-in.) | 2.83           |           |
| Nut weight (lbs)              | 8.55           |           |
| Ball Nut Part Number          | <b>5700698</b> |           |
| Flange Part Number            | <b>5707777</b> |           |
| Wiper Kit Part Number         | <b>5702657</b> |           |

\* Wiper kit included with this ball nut.

|                    |                |  |
|--------------------|----------------|--|
| Wiper Part Number  | <b>5702657</b> |  |
| Flange Part Number | <b>5707777</b> |  |

Note: Dimensional information for all End Journals and Bearing Supports is available on page 154. Information on required lubrication is on page 233.

**1.500 x 1.000**

**Precision Rolled Ball Screws — Inch Series**

|                                    |               |
|------------------------------------|---------------|
| <b>Diameter x Lead (in.)</b>       | 1.500 x 1.000 |
| <b>Lead Accuracy (in/ft)</b>       | ± 0.004       |
| <b>Screw Weight (lbs/ft)</b>       | 5.6           |
| <b>Screw Root Diameter (in.)</b>   | 1.14          |
| <b>Nominal Ball Diameter (in.)</b> | 0.344         |
| <b>Number of Starts</b>            | 2             |

**Ball Screw Part Numbers**

|                         |                 |             |                 |
|-------------------------|-----------------|-------------|-----------------|
| <b>Thread Direction</b> | Right Hand      | Left Hand   | Right Hand      |
| <b>Screw Material</b>   | Alloy Steel     | Alloy Steel | Stainless Steel |
| <b>Standard Length</b>  | 144"            |             |                 |
| <b>Maximum Length</b>   | 288"            |             |                 |
| <b>Part Number</b>      | <b>190-9107</b> |             |                 |

Ball screws can be cut to the length you require. Specify ball screw part number and overall length at time of order.

**Double Circuit, Round Ball Nut – High Speed**

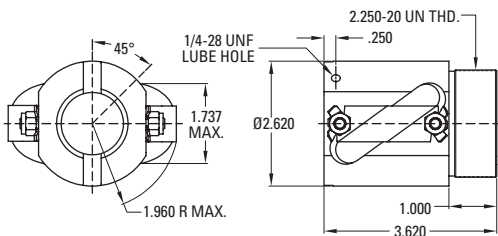

|                                      |                     |           |
|--------------------------------------|---------------------|-----------|
| <b>Thread Direction</b>              | Right Hand          | Left Hand |
| <b>Nut Material</b>                  | Alloy Steel         |           |
| <b>Dynamic Load (lbs)</b>            | 8,250               |           |
| <b>Max. Static Load (lbs)</b>        | 34,662              |           |
| <b>Torque to raise 1 lb (oz-in.)</b> | 2.83                |           |
| <b>Nut weight (lbs)</b>              | 3.90                |           |
| <b>Ball Nut Part Number</b>          | <b>8115-448-049</b> |           |
| <b>Flange Part Number</b>            | <b>8115-448-002</b> |           |
| <b>Wiper Kit Part Number*</b>        | <b>Integral</b>     |           |

**Double Circuit, Round Ball Nut**

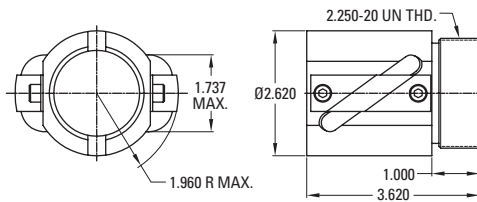

|                                      |                     |           |
|--------------------------------------|---------------------|-----------|
| <b>Thread Direction</b>              | Right Hand          | Left Hand |
| <b>Nut Material</b>                  | Alloy Steel         |           |
| <b>Dynamic Load (lbs)</b>            | 8,250               |           |
| <b>Max. Static Load (lbs)</b>        | 34,662              |           |
| <b>Torque to raise 1 lb (oz-in.)</b> | 2.83                |           |
| <b>Nut weight (lbs)</b>              | 3.90                |           |
| <b>Ball Nut Part Number</b>          | <b>8115-448-014</b> |           |
| <b>Flange Part Number</b>            | <b>8115-448-002</b> |           |
| <b>Wiper Kit Part Number*</b>        | <b>Internal</b>     |           |

\* Wiper kit included with this ball nut.

Note: Dimensional information for all End Journals and Bearing Supports is available on page 154. Information on required lubrication is on page 233.

# 1.500 x 1.000

## Precision Rolled Ball Screws — Inch Series

|                                    |               |
|------------------------------------|---------------|
| <b>Diameter x Lead (in.)</b>       | 1.500 x 1.000 |
| <b>Lead Accuracy (in/ft)</b>       | ± 0.004       |
| <b>Screw Weight (lbs/ft)</b>       | 5.6           |
| <b>Screw Root Diameter (in.)</b>   | 1.14          |
| <b>Nominal Ball Diameter (in.)</b> | 0.344         |
| <b>Number of Starts</b>            | 2             |

### Ball Screw Part Numbers

|                         |                 |             |                 |
|-------------------------|-----------------|-------------|-----------------|
| <b>Thread Direction</b> | Right Hand      | Left Hand   | Right Hand      |
| <b>Screw Material</b>   | Alloy Steel     | Alloy Steel | Stainless Steel |
| <b>Standard Length</b>  | 144"            |             |                 |
| <b>Maximum Length</b>   | 288"            |             |                 |
| <b>Part Number</b>      | <b>190-9107</b> |             |                 |

Ball screws can be cut to the length you require. Specify ball screw part number and overall length at time of order.

### Preloaded, Double Circuit, Round Ball Nut

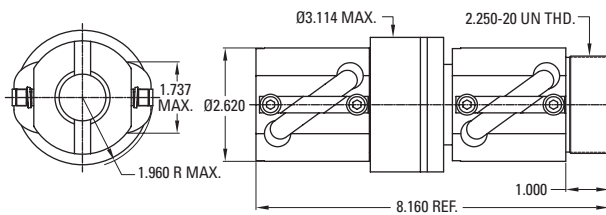

|                                      |                     |           |
|--------------------------------------|---------------------|-----------|
| <b>Thread Direction</b>              | Right Hand          | Left Hand |
| <b>Nut Material</b>                  | Alloy Steel         |           |
| <b>Dynamic Load (lbs)</b>            | 8,250               |           |
| <b>Max. Static Load (lbs)</b>        | 47,800              |           |
| <b>Torque to raise 1 lb (oz-in.)</b> | 2.83                |           |
| <b>Nut weight (lbs)</b>              | 8.60                |           |
| <b>Ball Nut Part Number</b>          | <b>8115-448-011</b> |           |
| <b>Flange Part Number</b>            | <b>8115-448-002</b> |           |
| <b>Wiper Kit Part Number*</b>        | <b>Internal</b>     |           |

### Wiper and Flange Kits

#### Wiper — 8115-101-012

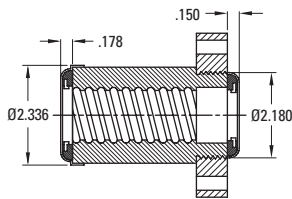

#### Flange

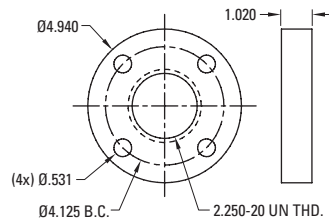

Note: Wiper kit does not include flange end cap.

|                                |                     |  |
|--------------------------------|---------------------|--|
| <b>Wiper Part Number (RND)</b> | <b>8115-101-004</b> |  |
| <b>Flange Part Number</b>      | <b>8115-448-002</b> |  |

\* Wiper kit included with this ball nut.

Note: Dimensional information for all End Journals and Bearing Supports is available on page 154. Information on required lubrication is on page 233.

**1.500 x 1.875**

**Precision Rolled Ball Screws — Inch Series**

|                             |               |
|-----------------------------|---------------|
| Diameter x Lead (in.)       | 1.500 x 1.875 |
| Lead Accuracy (in/ft)       | ± 0.004       |
| Screw Weight (lbs/ft)       | 5.3           |
| Screw Root Diameter (in.)   | 1.19          |
| Nominal Ball Diameter (in.) | 0.281         |
| Number of Starts            | 4             |

**Ball Screw Part Numbers**

|                  |                |             |
|------------------|----------------|-------------|
| Thread Direction | Right Hand     | Left Hand   |
| Screw Material   | Alloy Steel    | Alloy Steel |
| Standard Length  | 240"           |             |
| Maximum Length   | 240"           |             |
| Part Number      | <b>7820599</b> |             |

Ball screws can be cut to the length you require. Specify ball screw part number and overall length at time of order.

**Double Circuit, Square Ball Nut**

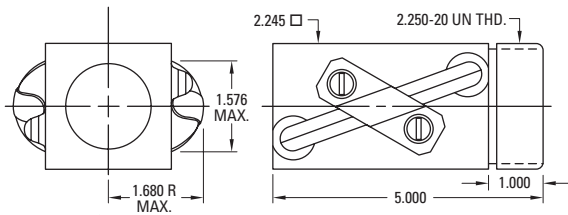

**p145** Quick Install Assembly

|                               |                |           |
|-------------------------------|----------------|-----------|
| Thread Direction              | Right Hand     | Left Hand |
| Nut Material                  | Alloy Steel    |           |
| Dynamic Load (lbs)            | 7,242          |           |
| Max. Static Load (lbs)        | 29,895         |           |
| Torque to raise 1 lb (oz-in.) | 5.31           |           |
| Nut weight (lbs)              | 4.22           |           |
| Ball Nut Part Number          | <b>5707654</b> |           |
| Flange Part Number            | <b>5707777</b> |           |
| Wiper Kit Part Number         | <b>5702658</b> |           |

**Preloaded, Double Circuit, Square Ball Nut**

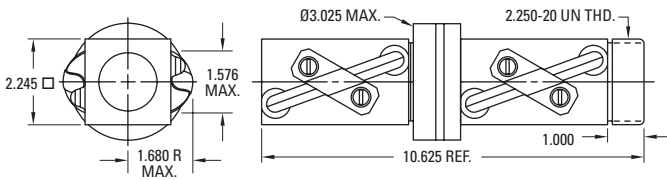

**p145** Quick Install Assembly

|                               |                |           |
|-------------------------------|----------------|-----------|
| Thread Direction              | Right Hand     | Left Hand |
| Nut Material                  | Alloy Steel    |           |
| Dynamic Load (lbs)            | 7,242          |           |
| Max. Static Load (lbs)        | 29,895         |           |
| Torque to raise 1 lb (oz-in.) | 5.31           |           |
| Nut weight (lbs)              | 9.93           |           |
| Ball Nut Part Number          | <b>5704272</b> |           |
| Flange Part Number            | <b>5707777</b> |           |
| Wiper Kit Part Number         | <b>5702658</b> |           |

**Quad Circuit, Square Ball Nut**

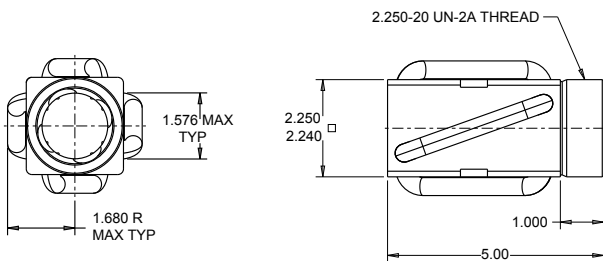

|                               |                |           |
|-------------------------------|----------------|-----------|
| Thread Direction              | Right Hand     | Left Hand |
| Nut Material                  | Alloy Steel    |           |
| Dynamic Load (lbs)            | 14,484         |           |
| Max. Static Load (lbs)        | 59,790         |           |
| Torque to raise 1 lb (oz-in.) | 5.31           |           |
| Nut weight (lbs)              | 4.25           |           |
| Ball Nut Part Number          | <b>7833714</b> |           |
| Flange Part Number            | <b>5707777</b> |           |
| Wiper Kit Part Number         | <b>5702658</b> |           |

**Wiper and Flange Kits**

**Wiper**

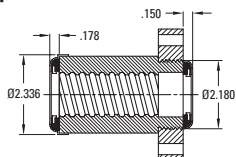

**Flange**

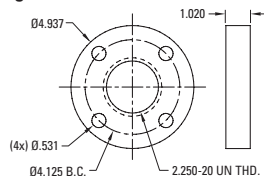

Note: Wiper kit does not include flange end cap.

|                    |                |  |
|--------------------|----------------|--|
| Wiper Part Number  | <b>5702658</b> |  |
| Flange Part Number | <b>5707777</b> |  |

Note: Dimensional information for all End Journals and Bearing Supports is available on page 154. Information on required lubrication is on page 233.

# 1.500 x 2.000

## Precision Rolled Ball Screws — Inch Series

|                             |               |
|-----------------------------|---------------|
| Diameter x Lead (in.)       | 1.500 x 2.000 |
| Lead Accuracy (in/ft)       | ± 0.004       |
| Screw Weight (lbs/ft)       | 5.6           |
| Screw Root Diameter (in.)   | 1.21          |
| Nominal Ball Diameter (in.) | 0.281         |
| Number of Starts            | 4             |

### Ball Screw Part Numbers

|                  |                 |             |                 |
|------------------|-----------------|-------------|-----------------|
| Thread Direction | Right Hand      | Left Hand   | Right Hand      |
| Screw Material   | Alloy Steel     | Alloy Steel | Stainless Steel |
| Standard Length  | 144"            |             |                 |
| Maximum Length   | 288"            |             |                 |
| Part Number      | <b>190-9345</b> |             |                 |

Ball screws can be cut to the length you require. Specify ball screw part number and overall length at time of order.

### Double Circuit, Round Ball Nut with Load Lock

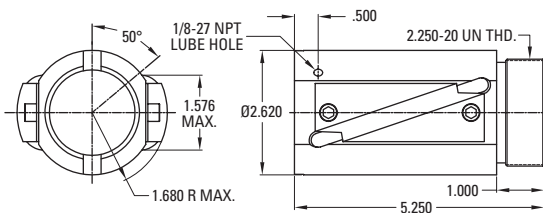

**p145** Quick Install Assembly

|                               |                     |           |
|-------------------------------|---------------------|-----------|
| Thread Direction              | Right Hand          | Left Hand |
| Nut Material                  | Alloy Steel         |           |
| Dynamic Load (lbs)            | 7,600               |           |
| Max. Static Load (lbs)        | 29,000              |           |
| Torque to raise 1 lb (oz-in.) | 5.66                |           |
| Nut weight (lbs)              | 5.00                |           |
| Ball Nut Part Number          | <b>8115-448-056</b> |           |
| Flange Part Number            | <b>8115-448-002</b> |           |
| Wiper Kit Part Number*        | Internal            |           |

### Double Circuit, Round Ball Nut with Load Lock — High Speed

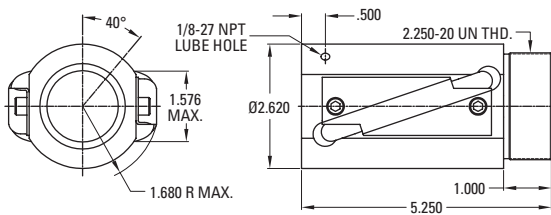

|                               |                     |           |
|-------------------------------|---------------------|-----------|
| Thread Direction              | Right Hand          | Left Hand |
| Nut Material                  | Alloy Steel         |           |
| Dynamic Load (lbs)            | 7,600               |           |
| Max. Static Load (lbs)        | 29,000              |           |
| Torque to raise 1 lb (oz-in.) | 5.66                |           |
| Nut weight (lbs)              | 5.00                |           |
| Ball Nut Part Number          | <b>8115-448-057</b> |           |
| Flange Part Number            | <b>8115-448-002</b> |           |
| Wiper Kit Part Number*        | Internal            |           |

### Flange Kit

#### Flange

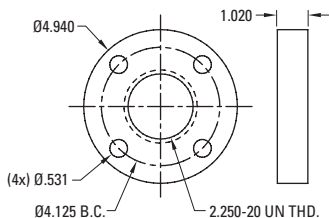

|                    |                     |  |
|--------------------|---------------------|--|
| Wiper Part Number  | <b>8115-101-004</b> |  |
| Flange Part Number | <b>8115-448-002</b> |  |

\* Wiper kit included with this ball nut.

Note: Dimensional information for all End Journals and Bearing Supports is available on page 154. Information on required lubrication is on page 233.



## 2.000 x 0.500

## Precision Rolled Ball Screws — Inch Series

|                             |               |
|-----------------------------|---------------|
| Diameter x Lead (in.)       | 2.000 x 0.500 |
| Lead Accuracy (in/ft)       | ± 0.004       |
| Screw Weight (lbs/ft)       | 9.8           |
| Screw Root Diameter (in.)   | 1.72          |
| Nominal Ball Diameter (in.) | 0.375         |
| Number of Starts            | 1             |

### Ball Screw Part Numbers

| Thread Direction | Right Hand      | Left Hand       | Right Hand      |
|------------------|-----------------|-----------------|-----------------|
| Screw Material   | Alloy Steel     | Alloy Steel     | Stainless Steel |
| Standard Length  | 144"            | 144"            |                 |
| Maximum Length   | 288"            | 288"            |                 |
| Part Number      | <b>190-9112</b> | <b>190-9113</b> |                 |

Ball screws can be cut to the length you require. Specify ball screw part number and overall length at time of order.

### Double Circuit, Round Ball Nut with Load Lock

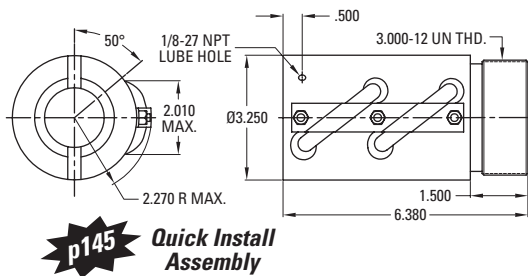

| Thread Direction              | Right Hand          | Left Hand           |
|-------------------------------|---------------------|---------------------|
| Nut Material                  | Alloy Steel         | Alloy Steel         |
| Dynamic Load (lbs)            | 18,500              | 18,500              |
| Max. Static Load (lbs)        | 154,635             | 154,635             |
| Torque to raise 1 lb (oz-in.) | 1.42                | 1.42                |
| Nut weight (lbs)              | 8.00                | 8.00                |
| Ball Nut Part Number          | <b>8120-448-011</b> | <b>8120-448-013</b> |
| Flange Part Number            | <b>8120-448-002</b> | <b>8120-448-002</b> |
| Wiper Kit Part Number*        | <b>Internal</b>     | <b>Internal</b>     |

### Preloaded, Double Circuit, Round Ball Nut with Load Lock

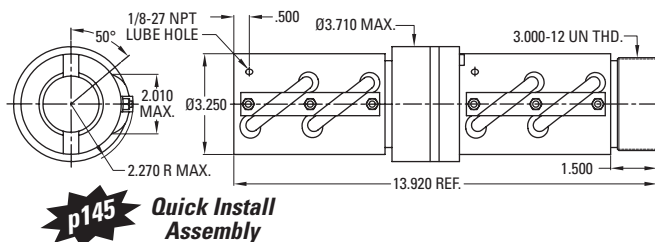

| Thread Direction              | Right Hand          | Left Hand           |
|-------------------------------|---------------------|---------------------|
| Nut Material                  | Alloy Steel         | Alloy Steel         |
| Dynamic Load (lbs)            | 18,500              | 18,500              |
| Max. Static Load (lbs)        | 154,635             | 154,635             |
| Torque to raise 1 lb (oz-in.) | 1.42                | 1.42                |
| Nut weight (lbs)              | 19.25               | 19.25               |
| Ball Nut Part Number          | <b>8120-448-006</b> | <b>8120-448-007</b> |
| Flange Part Number            | <b>8120-448-002</b> | <b>8120-448-002</b> |
| Wiper Kit Part Number*        | <b>Internal</b>     | <b>Internal</b>     |

### Flange Kit

#### Flange

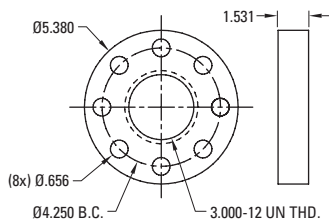

|                    |                     |
|--------------------|---------------------|
| Wiper Part Number  | <b>8120-101-002</b> |
| Flange Part Number | <b>8120-448-002</b> |

\* Wiper kit included with this ball nut.

Note: Dimensional information for all End Journals and Bearing Supports is available on page 154. Information on required lubrication is on page 233.

## 2.000 x 1.000

## Precision Rolled Ball Screws — Inch Series

|                             |               |
|-----------------------------|---------------|
| Diameter x Lead (in.)       | 2.000 x 1.000 |
| Lead Accuracy (in/ft)       | ± 0.004       |
| Screw Weight (lbs/ft)       | 9.8           |
| Screw Root Diameter (in.)   | 1.72          |
| Nominal Ball Diameter (in.) | 0.375         |
| Number of Starts            | 2             |

### Double Circuit, Round Ball Nut with Load Lock

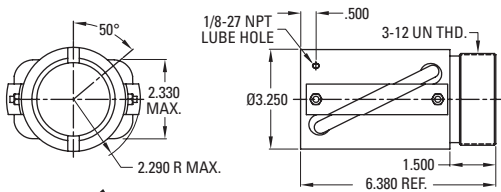

**p145** Quick Install Assembly

### Preloaded, Double Circuit, Round Ball Nut with Load Lock

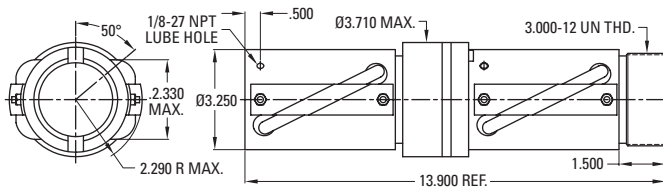

**p145** Quick Install Assembly

### Flange Kit

#### Flange

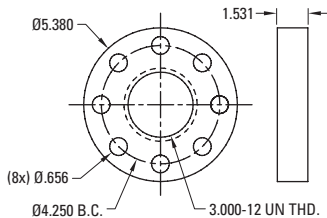

### Ball Screw Part Numbers

| Thread Direction | Right Hand      | Left Hand   | Right Hand      |
|------------------|-----------------|-------------|-----------------|
| Screw Material   | Alloy Steel     | Alloy Steel | Stainless Steel |
| Standard Length  | 144"            |             |                 |
| Maximum Length   | 288"            |             |                 |
| Part Number      | <b>190-9111</b> |             |                 |

Ball screws can be cut to the length you require. Specify ball screw part number and overall length at time of order.

| Thread Direction              | Right Hand          | Left Hand |
|-------------------------------|---------------------|-----------|
| Nut Material                  | Alloy Steel         |           |
| Dynamic Load (lbs)            | 21,200              |           |
| Max. Static Load (lbs)        | 152,605             |           |
| Torque to raise 1 lb (oz-in.) | 2.83                |           |
| Nut weight (lbs)              | 8.00                |           |
| Ball Nut Part Number          | <b>8120-448-021</b> |           |
| Flange Part Number            | <b>8120-448-002</b> |           |
| Wiper Kit Part Number*        | Internal            |           |

| Thread Direction              | Right Hand          | Left Hand |
|-------------------------------|---------------------|-----------|
| Nut Material                  | Alloy Steel         |           |
| Dynamic Load (lbs)            | 21,200              |           |
| Max. Static Load (lbs)        | 152,605             |           |
| Torque to raise 1 lb (oz-in.) | 2.83                |           |
| Nut weight (lbs)              | 19.25               |           |
| Ball Nut Part Number          | <b>8120-448-019</b> |           |
| Flange Part Number            | <b>8120-448-002</b> |           |
| Wiper Kit Part Number*        | Internal            |           |

|                    |                     |  |
|--------------------|---------------------|--|
| Wiper Part Number  | <b>8120-101-002</b> |  |
| Flange Part Number | <b>8120-448-002</b> |  |

\* Wiper kit included with this ball nut.

Note: Dimensional information for all End Journals and Bearing Supports is available on page 154. Information on required lubrication is on page 233.

## 2.250 x 0.500

## Precision Rolled Ball Screws — Inch Series

|                                    |               |
|------------------------------------|---------------|
| <b>Diameter x Lead (in.)</b>       | 2.250 x 0.500 |
| <b>Lead Accuracy (in/ft)</b>       | ± 0.004       |
| <b>Screw Weight (lbs/ft)</b>       | 10.9          |
| <b>Screw Root Diameter (in.)</b>   | 1.85          |
| <b>Nominal Ball Diameter (in.)</b> | 0.375         |
| <b>Number of Starts</b>            | 1             |

### Ball Screw Part Numbers

| Thread Direction       | Right Hand     | Left Hand      | Right Hand      |
|------------------------|----------------|----------------|-----------------|
| <b>Screw Material</b>  | Alloy Steel    | Alloy Steel    | Stainless Steel |
| <b>Standard Length</b> | 240"           | 240"           |                 |
| <b>Maximum Length</b>  | 240"           | 240"           |                 |
| <b>Part Number</b>     | <b>7820600</b> | <b>7820602</b> |                 |

Ball screws can be cut to the length you require. Specify ball screw part number and overall length at time of order.

### Double Circuit, Round Ball Nut with Load Lock

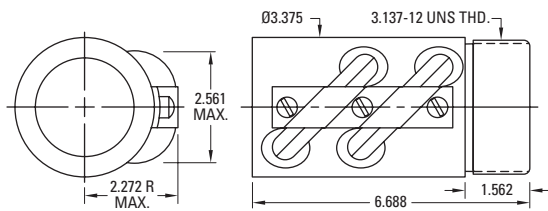

| Thread Direction                     | Right Hand      | Left Hand                    |
|--------------------------------------|-----------------|------------------------------|
| <b>Nut Material</b>                  | Alloy Steel     | Alloy Steel                  |
| <b>Dynamic Load (lbs)</b>            | 21,306          | 21,306                       |
| <b>Max. Static Load (lbs)</b>        | 161,150         | 161,150                      |
| <b>Torque to raise 1 lb (oz-in.)</b> | 1.42            | 1.42                         |
| <b>Nut weight (lbs)</b>              | 8.25            | 8.25                         |
| <b>Ball Nut Part Number</b>          | <b>7833235</b>  | <b>5704000<sup>(1)</sup></b> |
| <b>Flange Part Number</b>            | <b>5707574</b>  | <b>5707574</b>               |
| <b>Wiper Kit Part Number*</b>        | <b>Internal</b> | <b>Internal</b>              |

(1) Load Lock not available

### Flange Kit

#### Flange

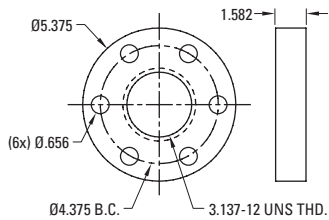

|                           |                |  |
|---------------------------|----------------|--|
| <b>Wiper Part Number</b>  | <b>5702659</b> |  |
| <b>Flange Part Number</b> | <b>5707574</b> |  |

\* Wiper kit included with this ball nut.

Note: Dimensional information for all End Journals and Bearing Supports is available on page 154. Information on required lubrication is on page 233.

## 2.250 x 1.000

## Precision Rolled Ball Screws — Inch Series

|                                    |               |
|------------------------------------|---------------|
| <b>Diameter x Lead (in.)</b>       | 2.250 x 1.000 |
| <b>Lead Accuracy (in/ft)</b>       | ± 0.004       |
| <b>Screw Weight (lbs/ft)</b>       | 10.9          |
| <b>Screw Root Diameter (in.)</b>   | 1.85          |
| <b>Nominal Ball Diameter (in.)</b> | 0.375         |
| <b>Number of Starts</b>            | 2             |

### Double Circuit, Round Ball Nut

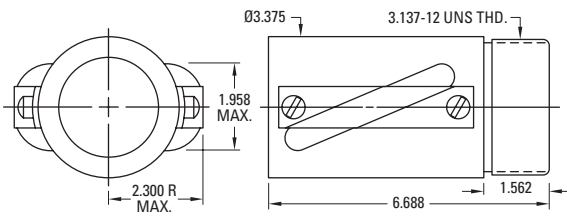

### Flange Kit

#### Flange

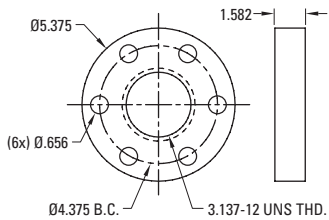

### Ball Screw Part Numbers

|                         |                |             |                 |
|-------------------------|----------------|-------------|-----------------|
| <b>Thread Direction</b> | Right Hand     | Left Hand   | Right Hand      |
| <b>Screw Material</b>   | Alloy Steel    | Alloy Steel | Stainless Steel |
| <b>Standard Length</b>  | 240"           |             |                 |
| <b>Maximum Length</b>   | 240"           |             |                 |
| <b>Part Number</b>      | <b>7820604</b> |             |                 |

Ball screws can be cut to the length you require. Specify ball screw part number and overall length at time of order.

|                                      |                 |           |
|--------------------------------------|-----------------|-----------|
| <b>Thread Direction</b>              | Right Hand      | Left Hand |
| <b>Nut Material</b>                  | Alloy Steel     |           |
| <b>Dynamic Load (lbs)</b>            | 26,538          |           |
| <b>Max. Static Load (lbs)</b>        | 161,150         |           |
| <b>Torque to raise 1 lb (oz-in.)</b> | 2.83            |           |
| <b>Nut weight (lbs)</b>              | 8.25            |           |
| <b>Ball Nut Part Number</b>          | <b>5704555</b>  |           |
| <b>Flange Part Number</b>            | <b>5707574</b>  |           |
| <b>Wiper Kit Part Number*</b>        | <b>Internal</b> |           |

|                           |                |  |
|---------------------------|----------------|--|
| <b>Wiper Part Number</b>  | <b>5702659</b> |  |
| <b>Flange Part Number</b> | <b>5707574</b> |  |

\* Wiper kit included with this ball nut.

Note: Dimensional information for all End Journals and Bearing Supports is available on page 154. Information on required lubrication is on page 233.

## 2.500 x 0.250

## Precision Rolled Ball Screws — Inch Series

|                             |               |
|-----------------------------|---------------|
| Diameter x Lead (in.)       | 2.500 x 0.250 |
| Lead Accuracy (in/ft)       | ± 0.004       |
| Screw Weight (lbs/ft)       | 15.5          |
| Screw Root Diameter (in.)   | 2.32          |
| Nominal Ball Diameter (in.) | 0.156         |
| Number of Starts            | 1             |

### Triple Circuit, Round Ball Nut

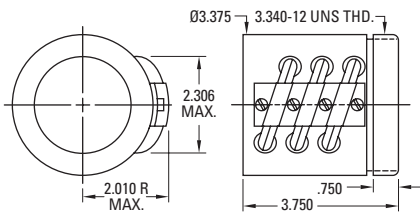

### Preloaded, Triple Circuit, Round Ball Nut with Integral Flange

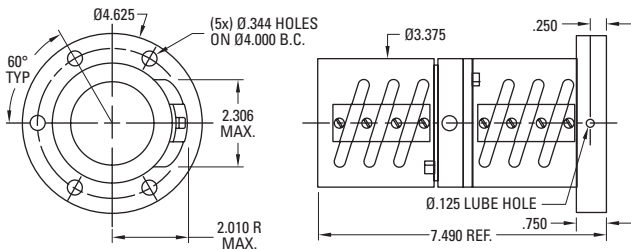

### Flange Kit

#### Flange

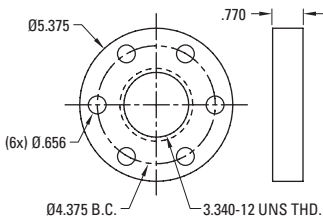

### Ball Screw Part Numbers

| Thread Direction | Right Hand     | Left Hand   | Right Hand      |
|------------------|----------------|-------------|-----------------|
| Screw Material   | Alloy Steel    | Alloy Steel | Stainless Steel |
| Standard Length  | 240"           |             |                 |
| Maximum Length   | 240"           |             |                 |
| Part Number      | <b>7820606</b> |             |                 |

Ball screws can be cut to the length you require. Specify ball screw part number and overall length at time of order.

| Thread Direction              | Right Hand      | Left Hand |
|-------------------------------|-----------------|-----------|
| Nut Material                  | Alloy Steel     |           |
| Dynamic Load (lbs)            | 6,315           |           |
| Max. Static Load (lbs)        | 81,938          |           |
| Torque to raise 1 lb (oz-in.) | 0.71            |           |
| Nut weight (lbs)              | 4.72            |           |
| Ball Nut Part Number          | <b>5703243</b>  |           |
| Flange Part Number            | <b>5703263</b>  |           |
| Wiper Kit Part Number*        | <b>Internal</b> |           |

| Thread Direction              | Right Hand      | Left Hand |
|-------------------------------|-----------------|-----------|
| Nut Material                  | Alloy Steel     |           |
| Dynamic Load (lbs)            | 6,315           |           |
| Max. Static Load (lbs)        | 81,938          |           |
| Torque to raise 1 lb (oz-in.) | 0.71            |           |
| Nut weight (lbs)              | 9.94            |           |
| Ball Nut Part Number          | <b>7823590</b>  |           |
| Flange Part Number            | <b>Integral</b> |           |
| Wiper Kit Part Number         | <b>Internal</b> |           |

|                    |                |  |
|--------------------|----------------|--|
| Wiper Part Number  | <b>5703324</b> |  |
| Flange Part Number | <b>5703263</b> |  |

\* Wiper kit included with this ball nut.

Note: Dimensional information for all End Journals and Bearing Supports is available on page 154. Information on required lubrication is on page 233.

## 2.500 x 0.500

## Precision Rolled Ball Screws — Inch Series

|                             |               |
|-----------------------------|---------------|
| Diameter x Lead (in.)       | 2.500 x 0.500 |
| Lead Accuracy (in/ft)       | ± 0.004       |
| Screw Weight (lbs/ft)       | 15.0          |
| Screw Root Diameter (in.)   | 2.22          |
| Nominal Ball Diameter (in.) | 0.375         |
| Number of Starts            | 1             |

### Double Circuit, Round Ball Nut with Load Lock

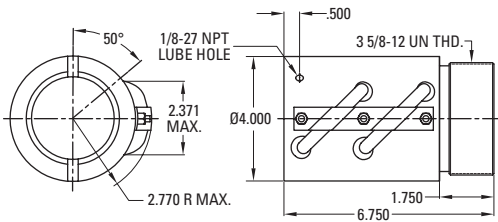

### Flange Kit

#### Flange

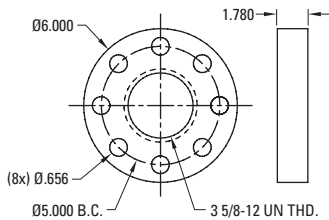

### Ball Screw Part Numbers

|                  |                 |             |                 |
|------------------|-----------------|-------------|-----------------|
| Thread Direction | Right Hand      | Left Hand   | Right Hand      |
| Screw Material   | Alloy Steel     | Alloy Steel | Stainless Steel |
| Standard Length  | 144"            |             |                 |
| Maximum Length   | 288"            |             |                 |
| Part Number      | <b>190-9116</b> |             |                 |

Ball screws can be cut to the length you require. Specify ball screw part number and overall length at time of order.

|                               |                     |           |
|-------------------------------|---------------------|-----------|
| Thread Direction              | Right Hand          | Left Hand |
| Nut Material                  | Alloy Steel         |           |
| Dynamic Load (lbs)            | 22,981              |           |
| Max. Static Load (lbs)        | 186,000             |           |
| Torque to raise 1 lb (oz-in.) | 1.42                |           |
| Nut weight (lbs)              | 13.00               |           |
| Ball Nut Part Number          | <b>8125-448-010</b> |           |
| Flange Part Number            | <b>8125-448-002</b> |           |
| Wiper Kit Part Number*        | Internal            |           |

|                    |                     |  |
|--------------------|---------------------|--|
| Wiper Part Number  | <b>8125-101-002</b> |  |
| Flange Part Number | <b>8125-448-002</b> |  |

\* Wiper kit included with this ball nut.

Note: Dimensional information for all End Journals and Bearing Supports is available on page 154. Information on required lubrication is on page 233.

## 2.500 x 1.000

## Precision Rolled Ball Screws — Inch Series

|                                    |               |
|------------------------------------|---------------|
| <b>Diameter x Lead (in.)</b>       | 2.500 x 1.000 |
| <b>Lead Accuracy (in/ft)</b>       | ± 0.004       |
| <b>Screw Weight (lbs/ft)</b>       | 15.0          |
| <b>Screw Root Diameter (in.)</b>   | 2.22          |
| <b>Nominal Ball Diameter (in.)</b> | 0.375         |
| <b>Number of Starts</b>            | 2             |

### Ball Screw Part Numbers

|                         |                 |             |                 |
|-------------------------|-----------------|-------------|-----------------|
| <b>Thread Direction</b> | Right Hand      | Left Hand   | Right Hand      |
| <b>Screw Material</b>   | Alloy Steel     | Alloy Steel | Stainless Steel |
| <b>Standard Length</b>  | 144"            |             |                 |
| <b>Maximum Length</b>   | 288"            |             |                 |
| <b>Part Number</b>      | <b>190-9115</b> |             |                 |

Ball screws can be cut to the length you require. Specify ball screw part number and overall length at time of order.

### Double Circuit, Round Ball Nut with Load Lock

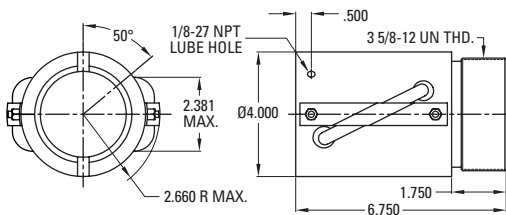

|                                      |                     |           |
|--------------------------------------|---------------------|-----------|
| <b>Thread Direction</b>              | Right Hand          | Left Hand |
| <b>Nut Material</b>                  | Alloy Steel         |           |
| <b>Dynamic Load (lbs)</b>            | 27,000              |           |
| <b>Max. Static Load (lbs)</b>        | 174,000             |           |
| <b>Torque to raise 1 lb (oz-in.)</b> | 2.83                |           |
| <b>Nut weight (lbs)</b>              | 13.00               |           |
| <b>Ball Nut Part Number</b>          | <b>8125-448-008</b> |           |
| <b>Flange Part Number</b>            | <b>8125-448-002</b> |           |
| <b>Wiper Kit Part Number*</b>        | <b>Internal</b>     |           |

### Flange Kit

#### Flange

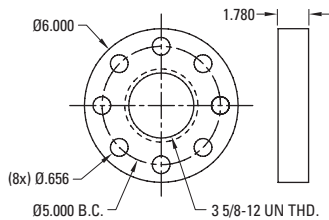

|                           |                     |  |
|---------------------------|---------------------|--|
| <b>Wiper Part Number</b>  | <b>8125-101-002</b> |  |
| <b>Flange Part Number</b> | <b>8125-448-002</b> |  |

\* Wiper kit included with this ball nut.

Note: Dimensional information for all End Journals and Bearing Supports is available on page 154. Information on required lubrication is on page 233.

## 3.000 x 0.660

## Precision Rolled Ball Screws — Inch Series

|                                    |               |
|------------------------------------|---------------|
| <b>Diameter x Lead (in.)</b>       | 3.000 x 0.660 |
| <b>Lead Accuracy (in/ft)</b>       | ± 0.004       |
| <b>Screw Weight (lbs/ft)</b>       | 18.3          |
| <b>Screw Root Diameter (in.)</b>   | 2.48          |
| <b>Nominal Ball Diameter (in.)</b> | 0.500         |
| <b>Number of Starts</b>            | 1             |

### Triple Circuit, Round Ball Nut with Load Lock

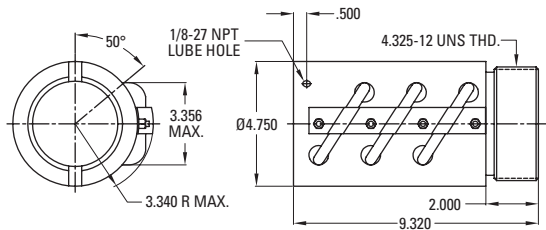

### Flange Kit

#### Flange

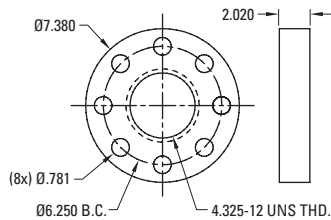

### Ball Screw Part Numbers

|                         |                 |             |                 |
|-------------------------|-----------------|-------------|-----------------|
| <b>Thread Direction</b> | Right Hand      | Left Hand   | Right Hand      |
| <b>Screw Material</b>   | Alloy Steel     | Alloy Steel | Stainless Steel |
| <b>Standard Length</b>  | 144"            |             |                 |
| <b>Maximum Length</b>   | 288"            |             |                 |
| <b>Part Number</b>      | <b>190-9117</b> |             |                 |

Ball screws can be cut to the length you require. Specify ball screw part number and overall length at time of order.

|                                      |                     |           |
|--------------------------------------|---------------------|-----------|
| <b>Thread Direction</b>              | Right Hand          | Left Hand |
| <b>Nut Material</b>                  | Alloy Steel         |           |
| <b>Dynamic Load (lbs)</b>            | 44,316              |           |
| <b>Max. Static Load (lbs)</b>        | 323,950             |           |
| <b>Torque to raise 1 lb (oz-in.)</b> | 1.87                |           |
| <b>Nut weight (lbs)</b>              | 26.00               |           |
| <b>Ball Nut Part Number</b>          | <b>8130-448-007</b> |           |
| <b>Flange Part Number</b>            | <b>8130-448-002</b> |           |
| <b>Wiper Kit Part Number*</b>        | <b>Internal</b>     |           |

|                           |                     |  |
|---------------------------|---------------------|--|
| <b>Wiper Part Number</b>  | <b>8130-101-002</b> |  |
| <b>Flange Part Number</b> | <b>8130-448-002</b> |  |

\* Wiper kit included with this ball nut.

Note: Dimensional information for all End Journals and Bearing Supports is available on page 154. Information on required lubrication is on page 233



**3.000 x 1.500**

**Precision Rolled Ball Screws — Inch Series**

|                                    |               |
|------------------------------------|---------------|
| <b>Diameter x Lead (in.)</b>       | 3.000 x 1.500 |
| <b>Lead Accuracy (in/ft)</b>       | ± 0.004       |
| <b>Screw Weight (lbs/ft)</b>       | 19.3          |
| <b>Screw Root Diameter (in.)</b>   | 2.48          |
| <b>Nominal Ball Diameter (in.)</b> | 0.500         |
| <b>Number of Starts</b>            | 2             |

**Ball Screw Part Numbers**

|                         |                |             |                 |
|-------------------------|----------------|-------------|-----------------|
| <b>Thread Direction</b> | Right Hand     | Left Hand   | Right Hand      |
| <b>Screw Material</b>   | Alloy Steel    | Alloy Steel | Stainless Steel |
| <b>Standard Length</b>  | 240"           |             |                 |
| <b>Maximum Length</b>   | 240"           |             |                 |
| <b>Part Number</b>      | <b>7820609</b> |             |                 |

Ball screws can be cut to the length you require. Specify ball screw part number and overall length at time of order.

**Double Circuit, Round Ball Nut**

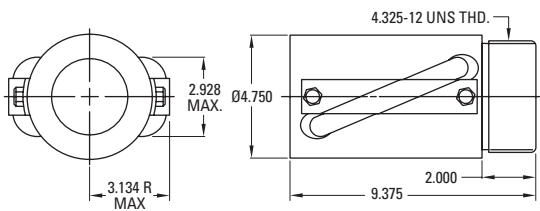

|                                      |                 |           |
|--------------------------------------|-----------------|-----------|
| <b>Thread Direction</b>              | Right Hand      | Left Hand |
| <b>Nut Material</b>                  | Alloy Steel     |           |
| <b>Dynamic Load (lbs)</b>            | 53,646          |           |
| <b>Max. Static Load (lbs)</b>        | 253,617         |           |
| <b>Torque to raise 1 lb (oz-in.)</b> | 4.25            |           |
| <b>Nut weight (lbs)</b>              | 27.2            |           |
| <b>Ball Nut Part Number</b>          | <b>5704986</b>  |           |
| <b>Flange Part Number</b>            | <b>5707575</b>  |           |
| <b>Wiper Kit Part Number*</b>        | <b>Internal</b> |           |

**Flange Kit**

**Flange**

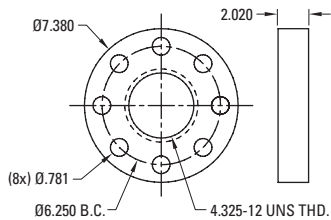

|                           |                |  |
|---------------------------|----------------|--|
| <b>Wiper Part Number</b>  | <b>5702661</b> |  |
| <b>Flange Part Number</b> | <b>5707575</b> |  |

\* Wiper kit included with this ball nut.

Note: Dimensional information for all End Journals and Bearing Supports is available on page 154. Information on required lubrication is on page 233.

## 4.000 x 1.000

## Precision Rolled Ball Screws — Inch Series

|                             |               |
|-----------------------------|---------------|
| Diameter x Lead (in.)       | 4.000 x 1.000 |
| Lead Accuracy (in/ft)       | ± 0.004       |
| Screw Weight (lbs/ft)       | 34.4          |
| Screw Root Diameter (in.)   | 3.34          |
| Nominal Ball Diameter (in.) | 0.625         |
| Number of Starts            | 1             |

### Triple Circuit, Round Ball Nut with Load Lock

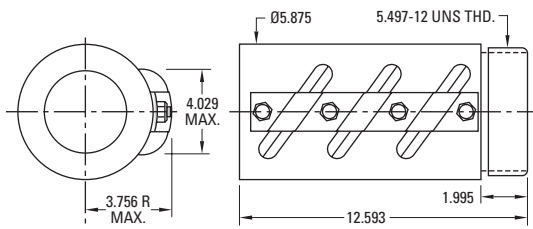

### Flange Kit

#### Flange

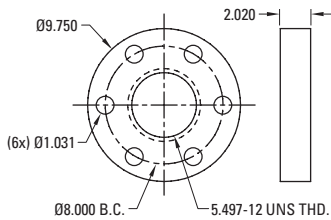

### Ball Screw Part Numbers

|                  |                |             |                 |
|------------------|----------------|-------------|-----------------|
| Thread Direction | Right Hand     | Left Hand   | Right Hand      |
| Screw Material   | Alloy Steel    | Alloy Steel | Stainless Steel |
| Standard Length  | 240"           |             |                 |
| Maximum Length   | 240"           |             |                 |
| Part Number      | <b>5703262</b> |             |                 |

Ball screws can be cut to the length you require. Specify ball screw part number and overall length at time of order.

|                               |                |           |
|-------------------------------|----------------|-----------|
| Thread Direction              | Right Hand     | Left Hand |
| Nut Material                  | Alloy Steel    |           |
| Dynamic Load (lbs)            | 85,758         |           |
| Max. Static Load (lbs)        | 476,970        |           |
| Torque to raise 1 lb (oz-in.) | 2.83           |           |
| Nut weight (lbs)              | 53.5           |           |
| Ball Nut Part Number          | <b>5703258</b> |           |
| Flange Part Number            | <b>5703307</b> |           |
| Wiper Kit Part Number*        | Internal       |           |

|                    |                |  |
|--------------------|----------------|--|
| Wiper Part Number  | <b>5703306</b> |  |
| Flange Part Number | <b>5703307</b> |  |

\* Wiper kit included with this ball nut.

Note: Dimensional information for all End Journals and Bearing Supports is available on page 154. Information on required lubrication is on page 233

## Visual Product Reference — Precision Rolled Ball Screws — Inch Series

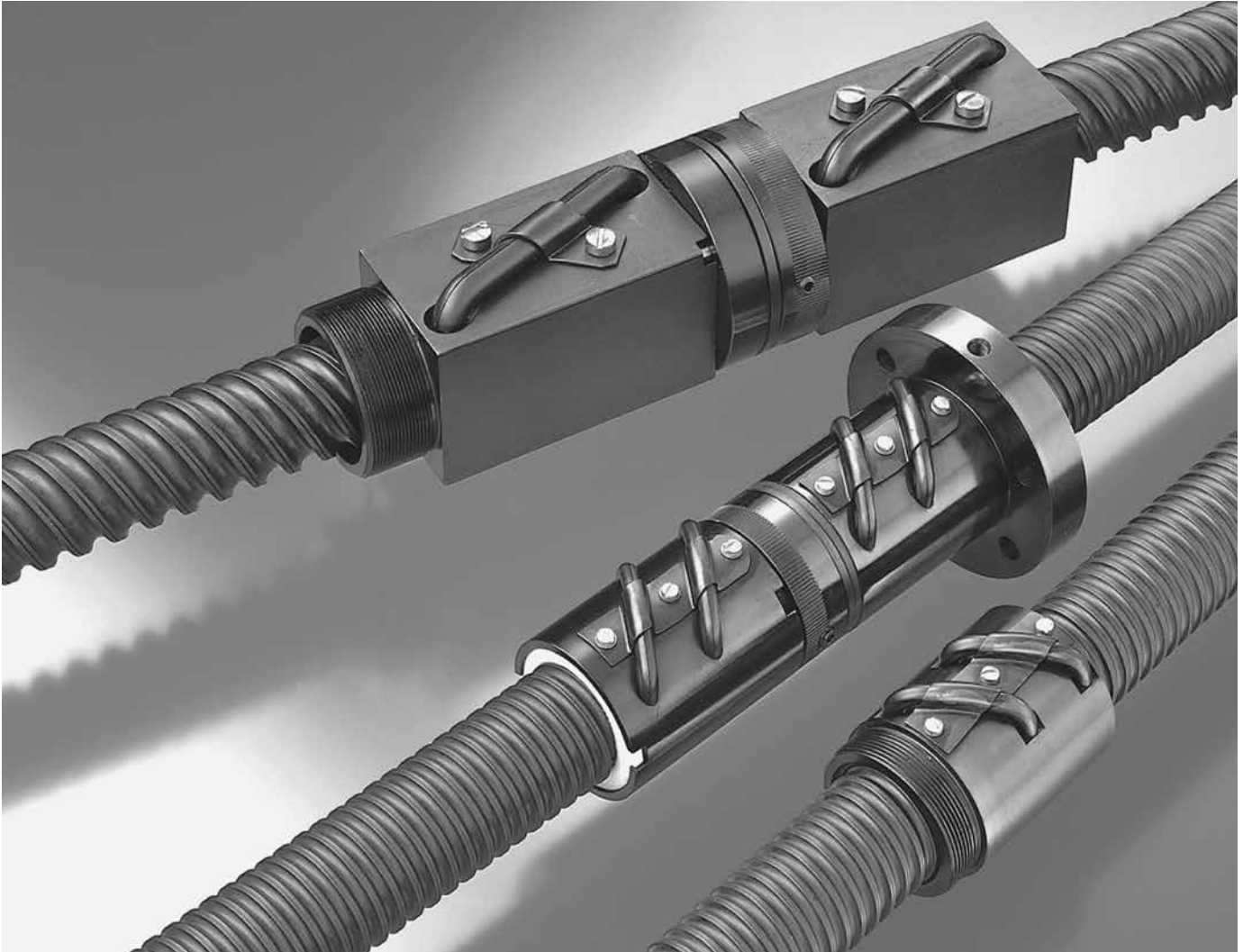

### Current and Historical Standard & Custom Ball Screw Components, Inch Series

The Visual Product Reference section is intended to document the many standard and custom ball screw components that have been produced by Thomson and Warner Linear. This section is intended to help identify existing customer product that may or may not be still shown as featured product in this catalog. Most of these products remain readily available for sale and can be ordered using the part numbers shown. The following tables are organized by ball nut shape and then sorted by ball circle diameter (BCD) and lead. Please contact the factory for assistance if the correct ball nut or screw cannot be identified or for any additional questions.

Need a quote or have a question about an application?  
Contact us in North America at:

Phone: 540-633-3549

Fax: 540-639-4162

Email: [thomson@thomsonlinear.com](mailto:thomson@thomsonlinear.com)

## Visual Product Reference — Precision Rolled Ball Screws — Inch Series

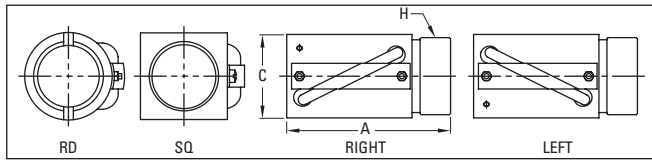

**Type A**

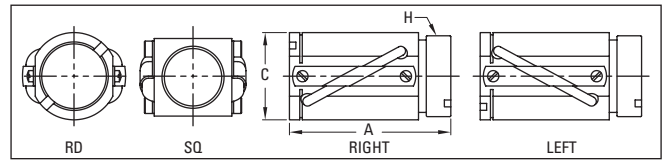

**Type B**

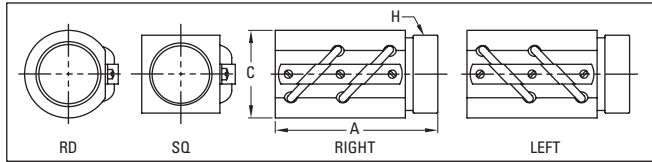

**Type C**

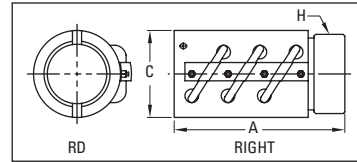

**Type D**

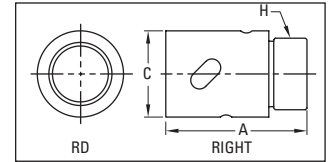

**Type E**

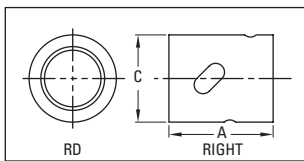

**Type F**

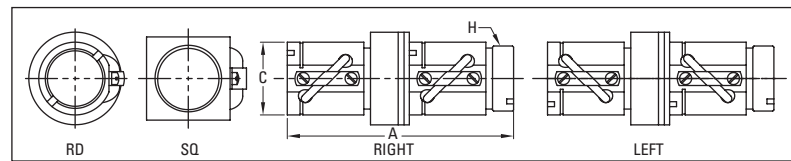

**Type G**

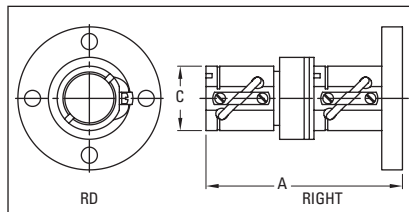

**Type H**

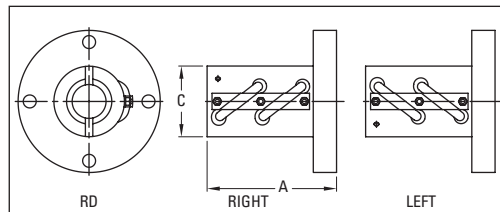

**Type J**

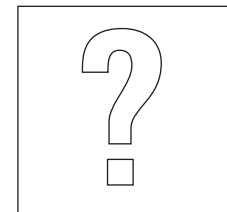

**Type Other**

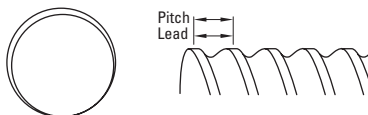

**Single Start**

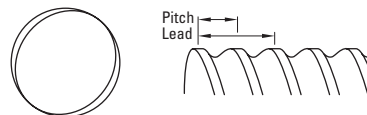

**Double Start**

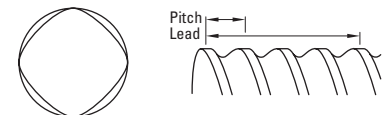

**Four Start**

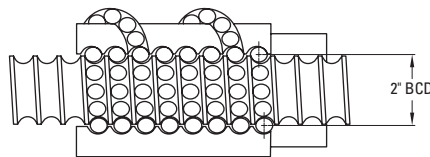

**Ball Circle Diameter (BCD)**

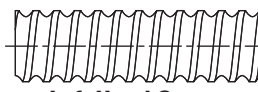

**Left Hand Screw**



**Right Hand Screw**

### Visual Product Reference Instructions

1. Visually determine the ball nut "Type" based on the above figures.
2. Narrow the choice by selecting the appropriate ball circle diameter (BCD) and lead as defined in the figure above.
3. If the ball nut has an identifying model number, this will uniquely identify the nut as shown in the 4th column of the tables. Unmarked nuts are listed as Thomson and will require dimensions to identify.
4. Count the number of ball return circuits and match to column 5.
5. Measure length, width/diameter, and V-thread (if applicable) of the ball nut and match to columns 6 – 8.
6. Determine if the thread direction is left or right by matching nut or screw (screw direction is shown in figure above) to provided figures and locating in column 9.
7. If the ball nut is not available, determine the number of starts of the screw (integral number of independent threads — see figures above), measure the screw major diameter, and measure the screw lead (distance between two adjacent turns of the screw — see figure above). Screw information is provided in columns 11 – 13.
8. Determine if the screw and/or nut material is either carbon steel (STEEL) or stainless steel (SS) and locate in column 14. Carbon steel nuts are coated with black oxide or other finish to prevent corrosion.

## Visual Product Reference — Precision Rolled Ball Screws — Inch Series

### Type A

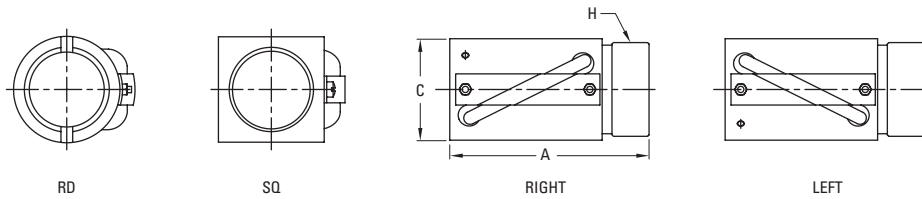

**Return:** Single Circuit  
**Shape:** Round or Square  
**Mounting:** V-Thread  
**Backlash:** Non-preloaded

| BCD (in.) | Lead (in.) | Shape | Nut Model | No. of Circuits | Length (in.) "A" | Width/Dia. (in.) "C" | V-Thd. "H" | Thd. Dir. | No. of Starts | Major Screw Dia. | Mat'l | Nut P/N      | Screw P/N | Flange P/N   | Wiper P/N    | Cat. Page |
|-----------|------------|-------|-----------|-----------------|------------------|----------------------|------------|-----------|---------------|------------------|-------|--------------|-----------|--------------|--------------|-----------|
| 0.375     | 0.125      | RD    | Thomson   | 1               | 1.000            | 0.750                | 0.664-32   | RH        | 1             | 0.365            | STEEL | 5709574      | 5707538   | 5706751      | N/A          | 48        |
| 0.375     | 0.125      | RD    | Thomson   | 1               | 1.000            | 0.750                | 0.664-32   | LH        | 1             | 0.365            | STEEL | 5709576      | 5708532   | 5706751      | N/A          | 48        |
| 0.375     | 0.125      | RD    | Thomson   | 1               | 1.000            | 0.750                | 0.664-32   | RH        | 1             | 0.365            | SS    | 5709578      | 5706540   | N/A          | N/A          | 48        |
| 0.375     | 0.125      | RD    | Thomson   | 1               | 1.170            | 0.750                | 11/16-28   | RH        | 1             | 0.370            | STEEL | 7831870      | 7824974   | N/A          | N/A          |           |
| 0.500     | 0.200      | RD    | RC0505    | 1               | 1.750            | 1.062                | 0.875-14   | RH        | 1             | 0.482            | STEEL | 8105-448-023 | 190-9097  | N/A          | 8105-101-002 | 51        |
| 0.631     | 0.200      | RD    | Thomson   | 1               | 1.710            | 1.125                | 1-16       | RH        | 1             | 0.620            | STEEL | 7832206      | 5707540   | 7832920      | N/A          |           |
| 0.631     | 0.200      | RD    | RC0605    | 1               | 1.710            | 1.125                | 15/16-16   | RH        | 1             | 0.610            | STEEL | 8106-448-006 | 190-9098  | 8105-448-002 | 8106-101-002 |           |
| 0.631     | 0.200      | RD    | RC0605    | 1               | 1.710            | 1.125                | 15/16-16   | RH        | 1             | 0.610            | STEEL | 8106-448-009 | 190-9098  | 8105-448-002 | 8106-101-002 | 54        |
| 0.631     | 0.200      | RD    | RE0605    | 1               | 1.710            | 1.125                | 15/16-16   | LH        | 1             | 0.610            | STEEL | 8106-448-007 | 190-9099  | 8105-448-002 | 8106-101-002 |           |
| 0.631     | 0.200      | RD    | RK0605    | 1               | 1.710            | 1.125                | 15/16-16   | LH        | 1             | 0.610            | STEEL | 8106-448-008 | 190-9099  | 8105-448-002 | 8106-101-002 | 54        |
| 0.631     | 0.200      | SQ    | Thomson   | 1               | 1.710            | 1.000                | 15/16-16   | RH        | 1             | 0.620            | SS    | 5707645      | 5705378   | N/A          | 5702647      | 54        |
| 0.631     | 0.200      | SQ    | Thomson   | 1               | 1.710            | 1.000                | 15/16-16   | RH        | 1             | 0.620            | STEEL | 7820827      | 5707540   | 5707570      | 5702647      |           |
| 0.631     | 0.200      | SQ    | Thomson   | 1               | 1.710            | 1.000                | 15/16-16   | LH        | 1             | 0.620            | STEEL | 7820828      | 5707541   | 5707570      | 5702647      |           |
| 0.631     | 0.200      | SQ    | RQ0605    | 1               | 1.710            | 1.000                | 15/16-16   | RH        | 1             | 0.610            | STEEL | 8106-448-010 | 190-9098  | 8105-448-002 | N/A          |           |
| 0.631     | 0.200      | SQ    | RQ0605    | 1               | 1.710            | 1.000                | 15/16-16   | RH        | 1             | 0.610            | STEEL | 8106-448-022 | 190-9098  | 8105-448-002 | N/A          | 54        |
| 0.631     | 0.200      | SQ    | RR0605    | 1               | 1.710            | 1.000                | 15/16-16   | LH        | 1             | 0.610            | STEEL | 8106-448-026 | 190-9099  | 8105-448-002 | N/A          | 54        |
| 0.631     | 0.200      | SQ    | RR0605    | 1               | 1.710            | 1.000                | 15/16-16   | LH        | 1             | 0.610            | STEEL | 8106-448-011 | 190-9099  | 8105-448-002 | N/A          |           |
| 0.750     | 0.200      | RD    | RC0705    | 1               | 1.880            | 1.312                | 1.173-18   | RH        | 1             | 0.765            | STEEL | 8107-448-017 | 190-9101  | 8107-448-007 | 8107-101-002 |           |
| 0.750     | 0.200      | RD    | RC0705    | 1               | 1.880            | 1.312                | 1.173-18   | RH        | 1             | 0.765            | STEEL | 8107-448-018 | 190-9101  | 8107-448-007 | 8107-101-002 | 58        |
| 0.750     | 0.200      | RD    | RC0705    | 1               | 1.880            | 1.312                | 1.25-18    | RH        | 1             | 0.765            | STEEL | 8107-448-047 | 190-9101  | N/A          | N/A          | 58        |
| 0.750     | 0.200      | RD    | RC0705STH | 1               | 1.880            | 1.312                | 1.125-18   | RH        | 1             | 0.765            | STEEL | 8107-448-026 | 190-9101  | N/A          | N/A          | 58        |
| 1.000     | 0.250      | RD    | RC1004    | 1               | 2.350            | 1.687                | 1-9/16-18  | RH        | 1             | 0.985            | STEEL | 8110-448-029 | 190-9104  | 8110-448-002 | 8110-101-002 |           |
| 1.000     | 0.250      | RD    | RC1004    | 1               | 2.350            | 1.687                | 1-9/16-18  | RH        | 1             | 0.985            | STEEL | 8110-448-032 | 190-9104  | 8110-448-002 | 8110-101-002 | 64        |
| 1.000     | 0.250      | RD    | RK1004    | 1               | 2.350            | 1.687                | 1-9/16-18  | LH        | 1             | 0.985            | STEEL | 8110-448-030 | 190-9105  | 8110-448-002 | 8110-101-002 | 64        |
| 1.000     | 0.250      | SQ    | Thomson   | 1               | 2.347            | 1.500                | 1.563-18   | RH        | 1             | 0.985            | STEEL | 5707508      | 7820426   | 5707571      | 5702649      |           |
| 1.000     | 0.250      | SQ    | Thomson   | 1               | 2.347            | 1.500                | 1.563-18   | LH        | 1             | 0.985            | STEEL | 5707535      | 7820428   | 5707571      | 5702649      |           |
| 1.000     | 0.250      | SQ    | RQ1004    | 1               | 2.347            | 1.500                | 1.563-18   | RH        | 1             | 0.985            | STEEL | 8110-448-055 | 190-9104  | 8110-448-002 | N/A          | 64        |

Note: Manganese Phosphate coating provided as standard finish on Thomson ball screws not featured in catalog pages.

## Visual Product Reference — Precision Rolled Ball Screws — Inch Series

### Type B

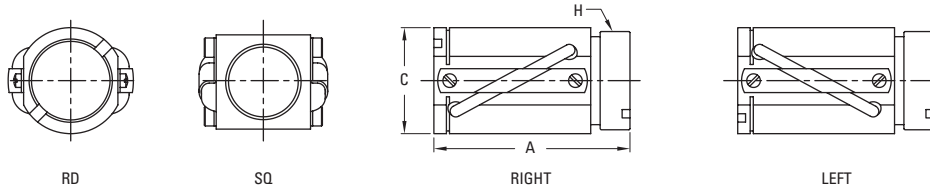

**Return:** Double Circuit  
**Shape:** Round or Square  
**Mounting:** V-Thread  
**Backlash:** Non-preloaded

| BCD (in.) | Lead (in.) | Shape | Nut Model | No. of Circuits | Length (in.) "A" | Width/Dia. (in.) "C" | V-Thd. "H" | Thd. Dir. | No. of Starts | Major Screw Dia. | Mat'l | Nut P/N      | Screw P/N | Flange P/N   | Wiper P/N    | Cat. Page |
|-----------|------------|-------|-----------|-----------------|------------------|----------------------|------------|-----------|---------------|------------------|-------|--------------|-----------|--------------|--------------|-----------|
| 0.500     | 0.500      | RD    | R-0502    | 2               | 2.750            | 1.062                | 15/16-16   | RH        | 2             | 0.510            | STEEL | 8105-448-011 | 190-9096  | 8105-448-002 | 8105-101-002 | 53        |
| 0.500     | 0.500      | RD    | R-0502    | 2               | 2.750            | 1.060                | 15/16-16   | RH        | 2             | 0.510            | STEEL | 8105-448-014 | 190-9096  | 8105-448-002 | 8105-101-002 | 53        |
| 0.500     | 0.500      | RD    | R-0502    | 2               | 2.750            | 1.062                | 15/16-16   | RH        | 2             | 0.510            | SS    | 8105-448-016 | 190-9010  | 8105-448-002 | 8105-101-002 | 53        |
| 0.500     | 0.500      | RD    | RS0502    | 2               | 2.750            | 1.062                | 15/16-16   | RH        | 2             | 0.510            | SS    | 8105-448-016 | 190-9010  | 8105-448-002 | 8105-101-002 |           |
| 0.500     | 0.500      | SQ    | Thomson   | 2               | 1.875            | 1.000                | 15/16-16   | RH        | 2             | 0.490            | STEEL | 5709582      | 5706740   | 5707570      | N/A          |           |
| 0.500     | 0.500      | SQ    | Thomson   | 2               | 1.875            | 1.000                | 15/16-16   | RH        | 2             | 0.490            | SS    | 5709584      | 5706846   | N/A          | N/A          |           |
| 0.631     | 1.000      | RD    | Thomson   | 2               | 1.710            | 1.125                | 15/16-16   | RH        | 2             | 0.620            | STEEL | 7826713      | 7826712   | 5707570      | 7827527      | 57        |
| 0.750     | 0.500      | RD    | Thomson   | 2               | 2.995            | 1.300                | 1.25-18    | RH        | 2             | 0.729            | STEEL | 7824358      | 7824361   | 7823336      | 7824337      |           |
| 0.750     | 0.500      | RD    | R-0702    | 2               | 2.930            | 1.312                | 1-1/4-16   | RH        | 2             | 0.765            | STEEL | 8107-448-014 | 190-9100  | 8107-448-002 | 8107-101-002 | 53        |
| 0.750     | 0.500      | RD    | R-0702    | 2               | 2.930            | 1.312                | 1.25-18    | RH        | 2             | 0.765            | STEEL | 8107-448-048 | 190-9100  | N/A          | N/A          | 61        |
| 0.750     | 0.500      | RD    | R-0702    | 2               | 2.930            | 1.312                | 1.173-18   | RH        | 2             | 0.765            | STEEL | 8107-448-049 | 190-9100  | 8107-448-007 | 8107-448-002 | 61        |
| 0.750     | 0.500      | RD    | RS0702    | 2               | 2.930            | 1.312                | 1-1/4-16   | RH        | 2             | 0.765            | SS    | 8107-448-020 | 190-9006  | 8107-448-020 | 8107-101-002 | 61        |
| 1.000     | 0.500      | RD    | Thomson   | 2               | 3.120            | 1.625                | 1-9/16-18  | RH        | 2             | 0.974            | STEEL | 7824286      | 7824290   | 5707571      | 7824292      |           |
| 1.000     | 0.500      | RD    | R-1002    | 2               | 3.120            | 1.687                | 1-9/16-18  | RH        | 2             | 1.015            | STEEL | 8110-448-022 | 190-9103  | 8110-448-002 | 8110-101-002 | 67        |
| 1.000     | 1.000      | RD    | R-1001    | 2               | 3.000            | 1.687                | 1-9/16-18  | RH        | 4             | 0.985            | STEEL | 8110-448-020 | 190-9102  | 8110-448-002 | 8110-101-002 | 68        |
| 1.000     | 1.000      | RD    | RS1001    | 2               | 3.000            | 1.687                | 1-9/16-18  | RH        | 4             | 0.985            | SS    | 8110-448-034 | 190-9150  | 8110-448-002 | 8110-101-002 | 68        |
| 1.000     | 1.000      | SQ    | Thomson   | 2               | 3.000            | 1.500                | 1.563-18   | RH        | 4             | 0.985            | STEEL | 5707509      | 7820429   | 5707571      | 5702650      |           |
| 1.000     | 1.000      | SQ    | RF1001    | 2               | 3.000            | 1.500                | 1.563-18   | RH        | 4             | 0.985            | STEEL | 8110-448-086 | 190-9102  | 8110-448-002 | N/A          | 68        |
| 1.500     | 1.000      | RD    | R-1501    | 2               | 3.620            | 2.620                | 2-1/4-20   | RH        | 2             | 1.480            | STEEL | 8115-448-014 | 190-9107  | 8115-448-002 | 8115-101-002 | 77        |
| 1.500     | 1.000      | RD    | RH1501    | 2               | 3.620            | 2.620                | 2-1/4-20   | RH        | 2             | 1.480            | STEEL | 8115-448-049 | 190-9107  | 8115-448-002 | 8115-101-004 | 77        |
| 1.500     | 1.000      | SQ    | Thomson   | 2               | 3.628            | 2.250                | 2-1/4-20   | LH        | 2             | 1.480            | STEEL | 5701995      | 7825925   | 5707777      | 5702657      |           |
| 1.500     | 1.000      | SQ    | Thomson   | 2               | 3.628            | 2.250                | 2-1/4-20   | RH        | 2             | 1.480            | STEEL | 5708280      | 7820598   | 5707777      | 5702657      |           |
| 1.500     | 1.000      | SQ    | Thomson   | 2               | 3.628            | 2.250                | 2-1/4-20   | RH        | 2             | 1.480            | STEEL | 20019711-10  | 7820598   | 5707777      | 5702657      |           |
| 1.500     | 1.000      | SQ    | Thomson   | 2               | 3.628            | 2.245                | 2-1/4-20   | RH        | 2             | 1.480            | STEEL | 5708280      | 7820598   | 5707777      | 5702657      | 76        |
| 1.500     | 1.000      | SQ    | Thomson   | 2               | 3.628            | 2.245                | 2-1/4-20   | RH        | 2             | 1.480            | STEEL | 7833724      | 7820598   | 5707777      | 5702657      | 76        |
| 1.500     | 1.000      | SQ    | Thomson   | 2               | 3.628            | 2.245                | 2-1/4-20   | LH        | 2             | 1.480            | STEEL | 5701995      | 7825925   | 5707777      | 5702657      | 76        |
| 1.500     | 1.875      | SQ    | Thomson   | 2               | 5.000            | 2.250                | 2-1/4-20   | RH        | 4             | 1.480            | STEEL | 5707654      | 7820599   | 5707777      | 5702658      | 79        |
| 1.500     | 2.000      | RD    | R-1520    | 2               | 5.260            | 2.620                | 2-1/4-20   | RH        | 4             | 1.435            | STEEL | 8115-448-056 | 190-9345  | 8115-448-002 | 8115-101-004 | 80        |
| 1.500     | 2.000      | RD    | RH1520 HS | 2               | 5.260            | 2.620                | 2-1/4-20   | RH        | 4             | 1.435            | STEEL | 8115-448-057 | 190-9345  | 8115-448-002 | 8115-101-004 | 80        |
| 2.000     | 1.000      | RD    | R-2001    | 2               | 6.380            | 3.250                | 3-12       | RH        | 2             | 2.045            | STEEL | 8120-448-021 | 190-9111  | 8120-448-002 | 8120-101-002 | 82        |
| 2.250     | 1.000      | RD    | Thomson   | 2               | 6.688            | 3.375                | 3.137-12   | RH        | 2             | 2.230            | STEEL | 5704555      | 7820604   | 5707574      | 5702659      | 84        |
| 2.500     | 1.000      | RD    | R-2501    | 2               | 6.750            | 4.000                | 3-5/8-12   | RH        | 2             | 2.545            | STEEL | 8125-448-008 | 190-9115  | 8125-448-002 | 8125-448-002 | 87        |
| 3.000     | 1.500      | RD    | Thomson   | 2               | 9.313            | 4.750                | 4.325-12   | RH        | 2             | 2.910            | STEEL | 5704986      | 7820609   | 5707575      | 5702661      | 89        |
| 4.000     | 1.000      | RD    | Thomson   | 3               | 12.593           | 5.875                | 5.497-12   | RH        | 1             | 3.785            | STEEL | 5703258      | 5703262   | 5703307      | 5703306      | 90        |

Note: Manganese Phosphate coating provided as standard finish on Thomson ball screws not featured in catalog pages.

## Visual Product Reference — Precision Rolled Ball Screws — Inch Series

### Type C

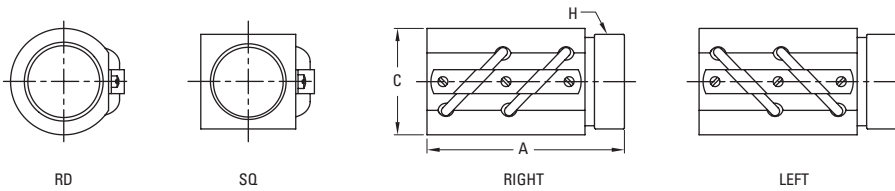

**Return:** Double Circuit  
**Shape:** Round or Square  
**Mounting:** V-Thread  
**Backlash:** Non-preloaded

| BCD (in.) | Lead (in.) | Shape | Nut Model | No. of Circuits | Length (in.) "A" | Width/Dia. (in.) "C" | V-Thd. "H" | Thd. Dir. | No. of Starts | Major Screw Dia. | Mat'l | Nut P/N      | Screw P/N | Flange P/N   | Wiper P/N    | Cat. Page |
|-----------|------------|-------|-----------|-----------------|------------------|----------------------|------------|-----------|---------------|------------------|-------|--------------|-----------|--------------|--------------|-----------|
| 0.375     | 0.125      | RD    | Thomson   | 2               | 1.875            | 0.750                | 0.664-32   | RH        | 1             | 0.365            | STEEL | 5707502      | 5707538   | 5706751      | N/A          |           |
| 0.375     | 0.125      | RD    | Thomson   | 2               | 1.875            | 0.750                | 0.664-32   | RH        | 1             | 0.365            | SS    | 5707643      | 5706540   | N/A          | N/A          |           |
| 0.375     | 0.125      | RD    | Thomson   | 2               | 1.875            | 0.750                | 0.664-32   | LH        | 1             | 0.365            | STEEL | 5708282      | 5708532   | 5706751      | N/A          |           |
| 0.375     | 0.125      | RD    | R-0308    | 2               | 1.880            | 0.781                | 11/16-24   | RH        | 1             | 0.380            | STEEL | 8103-448-003 | 190-9217  | 8103-448-002 | 8103-101-002 | 49        |
| 0.375     | 0.125      | RD    | R-0308LN  | 2               | 1.875            | 0.781                | 0.664-32   | RH        | 1             | 0.380            | STEEL | 8103-448-013 | 190-9217  | N/A          | 8103-101-002 | 49        |
| 0.500     | 0.200      | RD    | Thomson   | 2               | 2.600            | 1.030                | 15/16-16   | RH        | 1             | 0.482            | STEEL | 7826720      | 7826721   | 5707570      | 7826759      |           |
| 0.500     | 0.200      | RD    | R-0505    | 2               | 2.750            | 1.062                | 15/16-16   | RH        | 1             | 0.510            | STEEL | 8105-448-013 | 190-9097  | 8105-448-002 | 8105-101-002 | 52        |
| 0.631     | 0.200      | SQ    | R-0605    | 2               | 2.860            | 1.000                | 15/16-16   | RH        | 1             | 0.610            | STEEL | 8106-448-036 | 190-9098  | 8105-448-002 | N/A          | 55        |
| 0.631     | 0.200      | SQ    | R-0605    | 2               | 2.030            | 1.000                | 15/16-16   | LH        | 1             | 0.610            | STEEL | 8106-448-037 | 190-9099  | 8105-448-002 | N/A          | 56        |
| 0.750     | 0.200      | RD    | Thomson   | 2               | 2.635            | 1.300                | 1.25-18    | RH        | 1             | 0.727            | STEEL | 7824297      | 7824298   | 7823336      | 7824337      |           |
| 0.750     | 0.200      | RD    | R-0705    | 2               | 2.880            | 1.312                | 1.173-18   | RH        | 1             | 0.765            | STEEL | 8107-448-016 | 190-9101  | 8107-448-007 | 8107-101-002 | 59        |
| 0.750     | 0.200      | RD    | R-0705    | 2               | 2.880            | 1.312                | 1.25-18    | RH        | 1             | 0.765            | STEEL | 8107-448-046 | 190-9101  | N/A          | N/A          | 59        |
| 0.750     | 0.200      | RD    | R-0705STH | 2               | 2.880            | 1.312                | 1.125-18   | RH        | 1             | 0.765            | STEEL | 8107-448-027 | 190-9101  | N/A          | N/A          | 59        |
| 0.875     | 0.200      | RD    | Thomson   | 2               | 2.704            | 1.615                | 1-3/8-16   | RH        | 1             | 0.852            | STEEL | 5708277      | 5708859   | 5708281      | 7831512      | 63        |
| 1.000     | 0.250      | RD    | R-1004    | 2               | 3.130            | 1.687                | 1-9/16-18  | RH        | 1             | 0.985            | STEEL | 8110-448-026 | 190-9104  | 8110-448-002 | 8110-101-002 | 65        |
| 1.000     | 0.250      | RD    | RL1004    | 2               | 3.130            | 1.687                | 1-9/16-18  | LH        | 1             | 0.985            | STEEL | 8110-448-024 | 190-9105  | 8100-448-002 | 8110-101-002 | 65        |
| 1.000     | 0.250      | SQ    | Thomson   | 2               | 3.000            | 1.500                | 1.563-18   | RH        | 1             | 0.985            | STEEL | 5700348      | 7820426   | 5707571      | 5702649      |           |
| 1.000     | 0.250      | SQ    | RF1004    | 2               | 3.000            | 1.500                | 1.563-18   | RH        | 1             | 0.985            | STEEL | 8110-448-056 | 190-9104  | 8110-448-002 | N/A          | 64        |
| 1.150     | 0.200      | RD    | Thomson   | 2               | 2.500            | 1.687                | 1-5/8-20   | RH        | 1             | 1.130            | STEEL | 5701566      | 7820430   | 5708283      | 5702652      |           |
| 1.150     | 0.200      | RD    | Thomson   | 2               | 2.500            | 1.687                | 1-5/8-20   | LH        | 1             | 1.130            | STEEL | 7820207      | 7820431   | 5708283      | 5702652      |           |
| 1.150     | 0.200      | RD    | R-1105    | 2               | 2.500            | 1.687                | 1-5/8-20   | RH        | 1             | 1.130            | STEEL | 8111-448-006 | 190-9106  | 8111-448-002 | 8111-101-002 | 71        |
| 1.171     | 0.413      | RD    | Thomson   | 2               | 3.375            | 2.125                | 1.967-18   | RH        | 1             | 1.160            | STEEL | 5707511      | 7820432   | 5707572      | 5702653      | 72        |
| 1.500     | 0.250      | RD    | Thomson   | 2               | 2.875            | 2.088                | 1.967-18   | LH        | 1             | 1.485            | STEEL | 5701990      | 7820596   | 5706754      | 5702654      | 73        |
| 1.500     | 0.250      | RD    | Thomson   | 2               | 2.875            | 2.088                | 1.967-18   | RH        | 1             | 1.485            | STEEL | 5709587      | 7820595   | 5706754      | 5702654      |           |
| 1.500     | 0.250      | RD    | Thomson   | 2               | 2.875            | 2.088                | 1.967-18   | RH        | 1             | 1.485            | STEEL | 7833233      | 7820595   | 5706754      | 5702654      | 73        |
| 1.500     | 0.250      | RD    | R-1504    | 2               | 3.250            | 2.093                | 1.967-18   | RH        | 1             | 1.515            | STEEL | 8115-448-020 | 190-9110  | 8115-448-009 | 8115-101-006 |           |
| 1.500     | 0.473      | RD    | Thomson   | 2               | 4.312            | 2.625                | 2.548-18   | RH        | 1             | 1.470            | STEEL | 5707513      | 7820597   | 5707573      | 5702655      | 74        |
| 1.500     | 0.473      | RD    | Thomson   | 2               | 3.625            | 2.625                | N/A        | RH        | 1             | 1.470            | STEEL | 5708345      | 7820597   | N/A          | 5702656      |           |
| 1.500     | 0.473      | RD    | R-1547    | 2               | 4.307            | 2.620                | 2.548-18   | RH        | 1             | 1.415            | STEEL | 8115-448-055 | 190-9328  | 8115-448-064 | 8115-101-004 |           |
| 1.500     | 0.500      | RD    | Thomson   | 2               | 5.590            | 2.623                | 2.375-16   | RH        | 1             | 1.470            | STEEL | 7824246      | 7824253   | 7824250      | 7824251      |           |
| 1.500     | 0.500      | RD    | R-1502    | 2               | 5.565            | 2.620                | 2.360-18   | RH        | 1             | 1.535            | STEEL | 8115-448-016 | 190-9108  | 8115-448-018 | 8115-101-004 | 75        |
| 1.500     | 0.500      | RD    | RL1502    | 2               | 5.565            | 2.620                | 2.360-18   | LH        | 1             | 1.535            | STEEL | 8115-448-018 | 190-9109  | 8115-448-004 | 8115-101-004 | 75        |
| 2.000     | 0.500      | RD    | R-2002    | 2               | 6.380            | 3.250                | 3-12       | RH        | 1             | 2.045            | STEEL | 8120-448-011 | 190-9112  | 8120-448-002 | 8120-101-002 | 81        |
| 2.000     | 0.500      | RD    | RL2002    | 2               | 6.380            | 3.250                | 3-12       | LH        | 1             | 2.045            | STEEL | 8120-448-013 | 190-9113  | 8120-448-002 | 8120-101-002 | 81        |
| 2.250     | 0.500      | RD    | Thomson   | 2               | 6.688            | 3.375                | 3.137-12   | LH        | 1             | 2.230            | STEEL | 5704000      | 7820602   | 5707574      | 5702659      | 83        |
| 2.250     | 0.500      | RD    | Thomson   | 2               | 6.688            | 3.375                | 3.137-12   | RH        | 1             | 2.230            | STEEL | 5707516      | 7820600   | 5707574      | 5702659      |           |
| 2.250     | 0.500      | RD    | Thomson   | 2               | 6.688            | 3.375                | 3.137-12   | RH        | 1             | 2.230            | STEEL | 7833235      | 7820600   | 5707574      | 5702659      | 83        |
| 2.250     | 0.500      | RD    | Thomson   | 2               | 5.250            | 3.376                | N/A        | RH        | 1             | 2.230            | STEEL | 5708346      | 7820600   | N/A          | 5702659      |           |
| 2.250     | 0.500      | RD    | Thomson   | 2               | 5.250            | 3.376                | N/A        | LH        | 1             | 2.230            | STEEL | 7830722      | 7820602   | N/A          | 5702659      |           |
| 2.250     | 0.500      | RD    | R-2202    | 2               | 6.680            | 3.370                | 3.137-12   | RH        | 1             | 2.180            | STEEL | 8122-448-005 | 190-9114  | N/A          | 8122-101-002 |           |
| 2.500     | 0.500      | RD    | Thomson   | 2               | 6.750            | 3.625                | 3.5-12     | RH        | 1             | 2.480            | STEEL | 7824136      | 7824262   | 7824141      | 7824140      |           |
| 2.500     | 0.500      | RD    | R-2502    | 2               | 6.750            | 4.000                | 3-5/8-12   | RH        | 1             | 2.545            | STEEL | 8125-448-010 | 190-9116  | 8125-448-002 | 8125-101-002 | 86        |

Note: Manganese Phosphate coating provided as standard finish on Thomson ball screws not featured in catalog pages.

## Visual Product Reference — Precision Rolled Ball Screws — Inch Series

### Type D

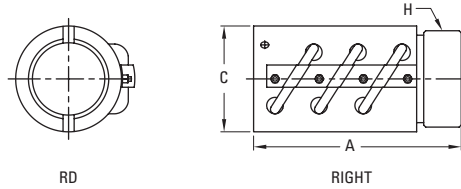

**Return:** Triple Circuit  
**Shape:** Round  
**Mounting:** V-Thread  
**Backlash:** Non-preloaded

| BCD (in.) | Lead (in.) | Shape | Nut Model | No. of Circuits | Length (in.) "A" | Width/ Dia. (in.) "C" | V-Thd. "H" | Thd. Dir. | No. of Starts | Major Screw Dia. | Mat'l | Nut P/N      | Screw P/N | Flange P/N   | Wiper P/N    | Cat. Page |
|-----------|------------|-------|-----------|-----------------|------------------|-----------------------|------------|-----------|---------------|------------------|-------|--------------|-----------|--------------|--------------|-----------|
| 2.500     | 0.250      | RD    | Thomson   | 3               | 3.750            | 3.375                 | 3.34-12    | RH        | 1             | 2.485            | STEEL | 5703243      | 7820606   | 5703263      | 5703324      | 85        |
| 3.000     | 0.660      | RD    | Thomson   | 3               | 9.313            | 4.750                 | 4.325-12   | RH        | 1             | 2.965            | STEEL | 5707519      | 7820607   | 5707575      | 5702661      |           |
| 3.000     | 0.660      | RD    | Thomson   | 3               | 7.000            | 4.750                 | N/A        | RH        | 1             | 2.965            | STEEL | 5708347      | 7820607   | N/A          | 5702662      |           |
| 3.000     | 0.660      | RD    | R-3066    | 3               | 9.320            | 4.750                 | 4.325-12   | RH        | 1             | 2.950            | STEEL | 8130-448-007 | 190-9117  | 8130-448-002 | 8130-101-002 | 88        |
| 4.000     | 1.000      | RD    | Thomson   | 3               | 12.593           | 5.875                 | 5.497-12   | RH        | 1             | 3.795            | STEEL | 5703258      | 5703262   | 5703307      | 5703306      | 90        |
| 6.000     | 1.000      | RD    | Thomson   | 3               | 14.438           | 9.000                 | 8.5-8      | RH        | 1             | 5.795            | STEEL | 5704738      | 5704762   | 5704764      | 5704746      |           |

### Type E

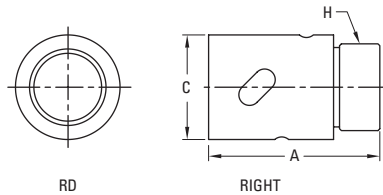

**Return:** Single-Liner  
**Shape:** Round  
**Mounting:** V-Thread  
**Backlash:** Non-preloaded

| BCD (in.) | Lead (in.) | Shape | Nut Model | No. of Circuits | Length (in.) "A" | Width/ Dia. (in.) "C" | V-Thd. "H" | Thd. Dir. | No. of Starts | Major Screw Dia. | Mat'l | Nut P/N      | Screw P/N | Flange P/N | Wiper P/N    | Cat. Page |
|-----------|------------|-------|-----------|-----------------|------------------|-----------------------|------------|-----------|---------------|------------------|-------|--------------|-----------|------------|--------------|-----------|
| 0.375     | 0.125      | RD    | RC0308    | 1               | 0.988            | 0.825                 | 11/16-24   | RH        | 1             | 0.380            | STEEL | 8103-448-008 | 190-9217  | N/A        | 8103-101-002 |           |
| 0.631     | 0.200      | RD    | Thomson   | 3               | 1.850            | 1.130                 | 15/16-16   | RH        | 1             | 0.620            | STEEL | 7832872      | 7832873   | 5707570    | INTEGRAL     | 56        |

### Type F

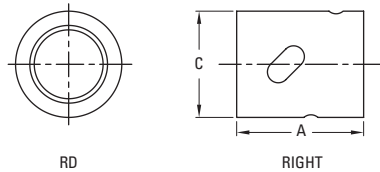

**Return:** Single-Liner  
**Shape:** Round  
**Mounting:** Cylindrical  
**Backlash:** Non-preloaded

| BCD (in.) | Lead (in.) | Shape | Nut Model | No. of Circuits | Length (in.) "A" | Width/ Dia. (in.) "C" | V-Thd. "H" | Thd. Dir. | No. of Starts | Major Screw Dia. | Mat'l | Nut P/N | Screw P/N | Flange P/N | Wiper P/N | Cat. Page |
|-----------|------------|-------|-----------|-----------------|------------------|-----------------------|------------|-----------|---------------|------------------|-------|---------|-----------|------------|-----------|-----------|
| 0.187     | 0.050      | RD    | Thomson   | 2               | 0.594            | 0.500                 | N/A        | RH        | 1             | 0.178            | SS    | 7821609 | 7821634   | N/A        | N/A       | 46        |
| 0.187     | 0.050      | RD    | Thomson   | 2               | 0.594            | 0.500                 | N/A        | RH        | 1             | 0.178            | EPOXY | 7821632 | 7821634   | N/A        | N/A       |           |
| 0.187     | 0.063      | RD    | Thomson   | 2               | 0.594            | 0.500                 | N/A        | RH        | 1             | 0.178            | SS    | 7821579 | 7821633   | N/A        | N/A       | 47        |
| 0.187     | 0.063      | RD    | Thomson   | 2               | 0.594            | 0.500                 | N/A        | RH        | 1             | 0.178            | EPOXY | 7821631 | 7821633   | N/A        | N/A       |           |

Note: Manganese Phosphate coating provided as standard finish on Thomson ball screws not featured in catalog pages.



## Visual Product Reference — Precision Rolled Ball Screws — Inch Series

### Type G

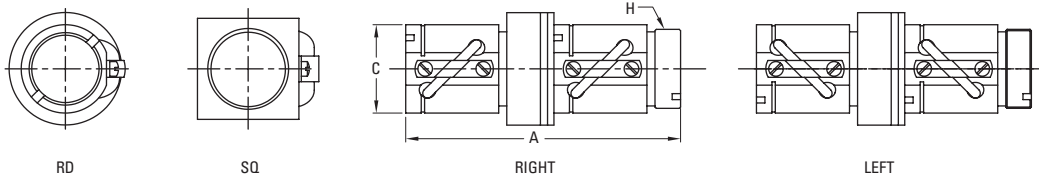

**Return:** See Table  
**Shape:** Round or Square  
**Mounting:** V-Thread  
**Backlash:** Preloaded

| BCD (in.) | Lead (in.) | Shape | Nut Model | No. of Circuits | Length (in.) "A" | Width/Dia. (in.) "C" | V-Thd. "H" | Thd. Dir. | No. of Starts | Major Screw Dia. | Mat'l | Nut P/N      | Screw P/N | Flange P/N   | Wiper P/N    | Cat. Page |
|-----------|------------|-------|-----------|-----------------|------------------|----------------------|------------|-----------|---------------|------------------|-------|--------------|-----------|--------------|--------------|-----------|
| 0.375     | 0.125      | RD    | RP0308    | 2 X 2           | 4.130            | 0.781                | 11/16-24   | RH        | 1             | 0.380            | STEEL | 8103-448-004 | 190-9217  | N/A          | 8103-101-002 |           |
| 0.500     | 0.200      | RD    | RP0505    | 2 X 2           | 5.950            | 1.062                | 15/16-16   | RH        | 1             | 0.510            | STEEL | 8105-448-008 | 190-9097  | 8105-448-002 | 8105-101-002 | 52        |
| 0.500     | 0.500      | RD    | RP0502    | 2 X 2           | 6.000            | 1.060                | 15/16-16   | RH        | 2             | 0.510            | SS    | 8105-448-009 | 190-9096  | 8105-448-002 | 8105-101-002 |           |
| 0.500     | 0.500      | SQ    | Thomson   | 2 X 2           | 3.875            | 1.000                | 15/16-16   | RH        | 2             | 0.490            | STEEL | 7826767      | 5706740   | 5707570      | N/A          |           |
| 0.631     | 0.200      | RD    | RD0605    | 2 X 1           | 3.797            | 1.125                | 15/16-16   | RH        | 1             | 0.610            | STEEL | 8106-448-015 | 190-9098  | 8105-448-002 | 8106-101-002 | 55        |
| 0.631     | 0.200      | RD    | RE0605    | 2 X 1           | 3.797            | 1.125                | 15/16-16   | LH        | 1             | 0.610            | STEEL | 8106-448-019 | 190-9099  | 8105-448-002 | 8106-101-002 | 55        |
| 0.631     | 0.200      | SQ    | Thomson   | 2 X 1           | 3.510            | 1.000                | 15/16-16   | RH        | 1             | 0.620            | STEEL | 7820955      | 5707540   | 5707570      | 5702647      |           |
| 0.631     | 0.200      | SQ    | Thomson   | 2 X 1           | 3.510            | 1.000                | 15/16-16   | LH        | 1             | 0.620            | STEEL | 7820956      | 5707541   | 5707570      | 5702647      |           |
| 0.631     | 0.200      | SQ    | RD0605    | 2 X 1           | 3.825            | 1.000                | 15/16-16   | RH        | 1             | 0.610            | STEEL | 8106-448-012 | 190-9098  | 8105-448-002 | N/A          | 55        |
| 0.631     | 1.000      | RD    | Thomson   | 2 X 2           | 3.440            | 1.125                | 15/16-16   | RH        | 4             | 0.620            | STEEL | 7827531      | 7826712   | 5707570      | 7827527      | 57        |
| 0.750     | 0.200      | RD    | RD0705    | 2 X 1           | 4.080            | 1.312                | 1.173-18   | RH        | 1             | 0.765            | STEEL | 8107-448-025 | 190-9101  | 8107-448-007 | 8107-101-002 | 60        |
| 0.750     | 0.500      | RD    | Thomson   | 2 X 2           | 5.750            | 1.300                | 1.25-18    | RH        | 2             | 0.729            | STEEL | 7826991      | 7824361   | 7823336      | 7824337      |           |
| 0.750     | 0.500      | RD    | RP0705    | 2 X 2           | 6.180            | 1.312                | 1.250-16   | RH        | 1             | 0.765            | STEEL | 8107-448-011 | 190-9100  | 8107-448-002 | 8107-101-002 | 62        |
| 1.000     | 0.250      | SQ    | Thomson   | 2 X 1           | 4.847            | 1.500                | 1.563-18   | RH        | 1             | 0.985            | STEEL | 5704167      | 7820426   | 5707571      | 5702649      | 66        |
| 1.000     | 0.250      | SQ    | Thomson   | 2 X 1           | 4.847            | 1.500                | 1.563-18   | LH        | 1             | 0.985            | STEEL | 5704168      | 7820428   | 5707571      | 5702649      | 66        |
| 1.000     | 0.500      | RD    | RP1002    | 2 X 2           | 6.640            | 1.687                | 1.563-18   | RH        | 2             | 1.015            | STEEL | 8110-448-016 | 190-9103  | 8110-448-002 | 8110-101-002 | 67        |
| 1.000     | 1.000      | SQ    | Thomson   | 2               | 6.000            | 1.500                | 1.563-18   | RH        | 4             | 0.985            | STEEL | 7829720      | 7820429   | 5707571      | 5702650      |           |
| 1.150     | 0.200      | RD    | Thomson   | 2 X 1           | 3.704            | 1.687                | 1-5/8-20   | RH        | 1             | 1.130            | STEEL | 5704270      | 7820430   | 5708283      | 5702652      |           |
| 1.150     | 0.200      | RD    | Thomson   | 2 X 1           | 3.704            | 1.687                | 1-5/8-20   | LH        | 1             | 1.130            | STEEL | 7820206      | 7820431   | 5708283      | 5702652      |           |
| 1.150     | 0.200      | RD    | RP1105    | 2 X 2           | 5.500            | 1.687                | 1.625-20   | RH        | 1             | 1.130            | STEEL | 8111-448-004 | 190-9106  | 8111-448-002 | 8111-101-002 | 71        |
| 1.500     | 0.250      | RD    | Thomson   | 2 X 2           | 6.375            | 2.088                | 1.967-18   | RH        | 1             | 1.485            | STEEL | 5704271      | 7820595   | 5706754      | 5702654      |           |
| 1.500     | 0.250      | RD    | Thomson   | 2 X 2           | 6.375            | 2.088                | 1.967-18   | RH        | 1             | 1.485            | STEEL | 7833234      | 7820595   | 5706754      | 5702654      | 73        |
| 1.500     | 0.250      | RD    | Thomson   | 2 X 2           | 6.375            | 2.088                | 1.967-18   | LH        | 1             | 1.485            | STEEL | 5704573      | 7820596   | 5706754      | 5702654      | 73        |
| 1.500     | 0.500      | RD    | RP1502    | 2 X 2           | 12.100           | 2.620                | 2.360-18   | RH        | 1             | 1.535            | STEEL | 8115-448-006 | 190-9108  | 8115-448-004 | 8115-101-004 | 75        |
| 1.500     | 1.000      | RD    | RP1501    | 2 X 2           | 8.160            | 2.620                | 2-1/4-20   | RH        | 2             | 1.480            | STEEL | 8115-448-011 | 190-9107  | 8115-448-002 | 8115-101-004 | 77        |
| 1.500     | 1.000      | SQ    | Thomson   | 2 X 2           | 7.628            | 2.250                | 2-1/4-20   | RH        | 2             | 1.480            | STEEL | 5700698      | 7820598   | 5707777      | 5702657      | 78        |
| 1.500     | 1.875      | SQ    | Thomson   | 2 X 2           | 10.625           | 2.245                | 2-1/4-20   | RH        | 4             | 1.480            | STEEL | 5704272      | 7820599   | 5707777      | 5702658      | 79        |
| 2.000     | 0.500      | RD    | RP2002    | 2 X 2           | 13.920           | 3.250                | 3-12       | RH        | 1             | 2.045            | STEEL | 8120-448-006 | 190-9112  | 8120-448-002 | 8120-101-002 | 81        |
| 2.000     | 0.500      | RD    | RT2002    | 2 X 2           | 13.920           | 3.250                | 3-12       | LH        | 1             | 2.045            | STEEL | 8120-448-007 | 190-9113  | 8120-448-002 | 8120-101-002 | 81        |
| 2.000     | 1.000      | RD    | RP2001    | 2 X 2           | 13.900           | 3.250                | 3-12       | RH        | 2             | 2.045            | STEEL | 8120-448-019 | 190-9111  | 8120-448-002 | 8120-101-002 | 82        |

Note: Manganese Phosphate coating provided as standard finish on Thomson ball screws not featured in catalog pages.

## Visual Product Reference — Precision Rolled Ball Screws — Inch Series

### Type H

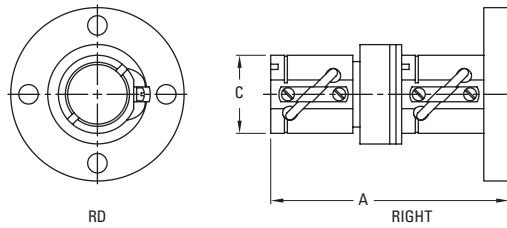

**Return:** See Table  
**Shape:** Round  
**Mounting:** Flange  
**Backlash:** Preloaded

| BCD (in.) | Lead (in.) | Shape | Nut Model | No. of Circuits | Length (in.) "A" | Width/ Dia. (in.) "C" | V-Thd. "H" | Thd. Dir. | No. of Starts | Major Screw Dia. | Mat'l | Nut P/N | Screw P/N | Flange P/N | Wiper P/N | Cat. Page |
|-----------|------------|-------|-----------|-----------------|------------------|-----------------------|------------|-----------|---------------|------------------|-------|---------|-----------|------------|-----------|-----------|
| 0.631     | 0.200      | RD    | Thomson   | 2 X 1           | 3.775            | 1.130                 | N/A        | RH        | 1             | 0.620            | STEEL | 7823584 | 5707540   | INTEGRAL   | INTEGRAL  |           |
| 0.875     | 0.200      | RD    | Thomson   | 2 X 1           | 3.835            | 1.250                 | N/A        | RH        | 1             | 0.852            | STEEL | 7823585 | 5708859   | INTEGRAL   | INTEGRAL  |           |
| 0.875     | 0.200      | RD    | Thomson   | 2 X 1           | 3.835            | 1.250                 | N/A        | RH        | 1             | 0.852            | STEEL | 7833677 | 5708859   | INTEGRAL   | INTEGRAL  | 63        |
| 1.000     | 0.250      | RD    | Thomson   | 2 X 1           | 4.438            | 1.620                 | N/A        | RH        | 1             | 0.985            | STEEL | 7823586 | 7820426   | INTEGRAL   | INTEGRAL  | 66        |
| 1.150     | 0.200      | RD    | Thomson   | 2 X 1           | 3.821            | 1.688                 | N/A        | RH        | 4             | 1.130            | STEEL | 7823587 | 7820430   | INTEGRAL   | INTEGRAL  | 70        |
| 1.500     | 0.250      | RD    | Thomson   | 2 X 2           | 6.845            | 2.088                 | N/A        | RH        | 1             | 1.485            | STEEL | 7823588 | 7820595   | INTEGRAL   | INTEGRAL  |           |
| 2.250     | 0.500      | RD    | Thomson   | 2 X 2           | 13.787           | 3.375                 | N/A        | RH        | 1             | 2.230            | STEEL | 7823589 | 7820600   | INTEGRAL   | INTEGRAL  |           |
| 2.500     | 0.250      | RD    | Thomson   | 2 X 3           | 7.490            | 3.375                 | N/A        | RH        | 1             | 2.485            | STEEL | 7823590 | 7820606   | INTEGRAL   | INTEGRAL  | 85        |
| 3.000     | 0.660      | RD    | Thomson   | 2 X 3           | 18.549           | 4.750                 | N/A        | RH        | 1             | 2.965            | STEEL | 5703045 | 7820607   | INTEGRAL   | INTEGRAL  |           |

### Type J

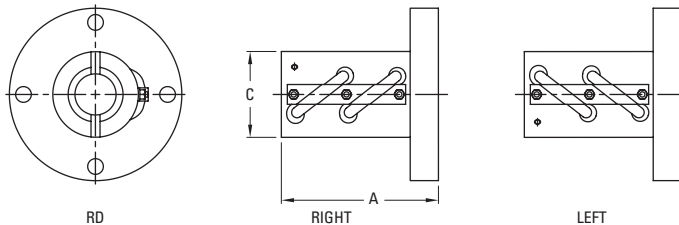

**Return:** Double Circuit  
**Shape:** Round  
**Mounting:** Flange  
**Backlash:** Non-preloaded

| BCD (in.) | Lead (in.) | Shape | Nut Model | No. of Circuits | Length (in.) "A" | Width/ Dia. (in.) "C" | V-Thd. "H" | Thd. Dir. | No. of Starts | Major Screw Dia. | Mat'l | Nut P/N      | Screw P/N | Flange P/N | Wiper P/N | Cat. Page |
|-----------|------------|-------|-----------|-----------------|------------------|-----------------------|------------|-----------|---------------|------------------|-------|--------------|-----------|------------|-----------|-----------|
| 1.000     | 0.250      | RD    | Thomson   | 2               | 3.000            | 1.625                 | N/A        | RH        | 1             | 0.985            | STEEL | 5708278      | 7820426   | INTEGRAL   | 5702651   |           |
| 1.000     | 0.250      | RD    | Thomson   | 2               | 3.000            | 1.625                 | N/A        | LH        | 1             | 0.985            | STEEL | 5708284      | 7820428   | INTEGRAL   | 5702651   |           |
| 1.000     | 0.250      | RD    | R-1004F   | 2               | 3.000            | 1.625                 | N/A        | RH        | 1             | 0.985            | STEEL | 8110-448-087 | 190-9104  | INTEGRAL   | 5702651   | 65        |
| 1.000     | 0.250      | RD    | RL1004F   | 2               | 3.000            | 1.625                 | N/A        | LH        | 1             | 0.985            | STEEL | 8110-448-088 | 190-9105  | INTEGRAL   | 5702651   | 65        |

Note: Manganese Phosphate coating provided as standard finish on Thomson ball screws not featured in catalog pages.

## Visual Product Reference — Precision Rolled Ball Screws — Inch Series

### Type Other



**Return:** See Table  
**Shape:** Miscellaneous  
**Mounting:** Miscellaneous  
**Backlash:** Miscellaneous

| BCD (in.) | Lead (in.) | Shape | Nut Model | No. of Circuits | Length (in.) "A" | Width/Dia. (in.) "C" | V-Thd. "H" | Thd. Dir. | No. of Starts | Major Screw Dia. | Mat'l | Nut P/N        | Screw P/N      | Flange P/N | Wiper P/N       | Cat. Page |
|-----------|------------|-------|-----------|-----------------|------------------|----------------------|------------|-----------|---------------|------------------|-------|----------------|----------------|------------|-----------------|-----------|
| 0.312     | 0.100      | RD    | Thomson   | 4               | 1.180            | 0.625                | 0.586-32   | RH        | 1             | 0.292            | STEEL | <b>7832875</b> | <b>7832897</b> | <b>N/A</b> | <b>N/A</b>      |           |
| 0.375     | 0.063      | RD    | Thomson   | 8               | 1.180            | 0.750                | 11/16-32   | RH        | 1             | 0.3685           | STEEL | <b>7832874</b> | <b>7832894</b> | <b>N/A</b> | <b>N/A</b>      |           |
| 0.375     | 0.125      | RD    | Thomson   | 1               | 0.677            | 0.749                | N/A        | RH        | 1             | 0.482            | STEEL | <b>7824973</b> | <b>7824974</b> | <b>N/A</b> | <b>N/A</b>      |           |
| 0.500     | 0.200      | RD    | Thomson   | 3               | 1.660            | 0.943                | N/A        | RH        | 1             | 0.482            | STEEL | <b>7826763</b> | <b>7826721</b> | <b>N/A</b> | <b>INTEGRAL</b> |           |
| 0.500     | 0.500      | RD    | Thomson   | 2               | 1.500            | 1.320                | N/A        | RH        | 2             | 0.490            | STEEL | <b>5707506</b> | <b>5706740</b> | <b>N/A</b> | <b>N/A</b>      |           |
| 0.500     | 0.500      | RD    | Thomson   | 2               | 1.500            | 1.320                | N/A        | RH        | 2             | 0.490            | SS    | <b>5707644</b> | <b>5706846</b> | <b>N/A</b> | <b>N/A</b>      |           |
| 0.750     | 0.200      | RD    | Thomson   | 4               | 1.800            | 1.297                | N/A        | RH        | 1             | 0.734            | STEEL | <b>7826768</b> | <b>7826770</b> | <b>N/A</b> | <b>INTEGRAL</b> |           |
| 1.500     | 1.875      | SQ    | Thomson   | 4               | 5.000            | 2.290                | 2 1/4-20   | RH        | 1             | 1.480            | STEEL | <b>7833714</b> | <b>7820599</b> | <b>N/A</b> | <b>N/A</b>      | 79        |

Note: Manganese Phosphate coating provided as standard finish on Thomson ball screws not featured in catalog pages.

Note: These ball nuts available for high quantity purchase only (100 piece minimum order required).

**NOTES:**

A large grid of graph paper for taking notes, consisting of 30 columns and 40 rows of small squares.

## Precision Plus Ball Screws — Inch Series



**High accuracy and stiffness with zero backlash,  
for stringent applications where ball screw performance  
is critical.**

Thomson Precision Plus Ball Screw Assemblies provide the positioning accuracy and repeatability required for the most stringent positioning applications. Thomson assemblies are designed and manufactured to provide 8 times the lead accuracy of conventional ball screws ( $\pm .0005$  in/ft), and provide consistent, zero-backlash, preload for high repeatability. All ball nuts feature an integral flange for optimal precision and mounting ease, and specially designed seals/wipers that provide superior lubricant retention while keeping out harmful contaminants. Precision Plus Assemblies are ideal for machine tools, robots, semi-conductor/electronic assembly systems, and many more applications where high-level ball screw performance is required.

Need a quote or have a question about an application?  
Contact us in North America at:

Phone: 540-633-3549

Fax: 540-639-4162

Email: [thomson@thomsonlinear.com](mailto:thomson@thomsonlinear.com)

## Precision Plus Ball Screws — Inch Series

Lead Accuracy:  $\pm .0005$  in/ft



### Preloaded, Round Ball Nut with Integral Flange and Wiper

- Precision machined for highly accurate and smooth running performance
- Long-lasting preload for minimal backlash and consistent stiffness
- Standard sizes stocked for quick delivery. Additional sizes are available as custom product.

| Nominal Diameter (size) | Lead  | Ball Screw and Nut Assembly P/N <sup>(1)(2)(3)</sup> | Ball Nut Details |                     | Performance Data                         |  |                     | Screw Specifications  |                |                 |              |
|-------------------------|-------|--|------------------|---------------------|--|--|---------------------|-----------------------|----------------|-----------------|--------------|
|                         |       |  | Direction        | No. of Return Tubes | Dynamic Load Capacity (C <sub>am</sub> ) | Static Load Capacity (C <sub>0</sub> ) | Max. Axial Backlash | Major Diameter (max.) | Minor Diameter | Standard Length | Screw Weight |
| (in.)                   | (in.) |  |                  |                     | (lbf)                                    | (lbf)                                  | (in.)               | (in.)                 | (in.)          | (in.)           | (lb/ft)      |
| 0.631                   | 0.200 | <b>7820396</b>                                       | Right Hand       | 2                   | 440                                      | 2,110                                  | 0.00                | 0.611                 | 0.496          | 42              | 0.90         |
| 0.750                   | 0.200 | <b>5700974</b>                                       | Right Hand       | 2                   | 1,473                                    | 9,916                                  | 0.00                | 0.750                 | 0.599          | 42              | 1.45         |
| 0.875                   | 0.200 | <b>7820397</b>                                       | Right Hand       | 2                   | 1,375                                    | 10,780                                 | 0.00                | 0.875                 | 0.740          | 60              | 1.78         |
| 1.000                   | 0.200 | <b>5700975</b>                                       | Right Hand       | 2                   | 1,565                                    | 13,073                                 | 0.00                | 1.000                 | 0.865          | 72              | 2.20         |
| 1.000                   | 0.250 | <b>7820477</b>                                       | Right Hand       | 2                   | 2,285                                    | 15,815                                 | 0.00                | 1.000                 | 0.833          | 72              | 2.20         |
| 1.150                   | 0.200 | <b>5700976</b>                                       | Right Hand       | 2                   | 1,680                                    | 14,886                                 | 0.00                | 1.130                 | 1.015          | 72              | 3.18         |
| 1.250                   | 0.200 | <b>5700977</b>                                       | Right Hand       | 2                   | 1,800                                    | 16,625                                 | 0.00                | 1.250                 | 1.115          | 72              | 3.75         |
| 1.250                   | 0.200 | <b>7820830</b>                                       | Left Hand        | 2                   | 1,800                                    | 16,625                                 | 0.00                | 1.235                 | 1.115          | 72              | 3.75         |
| 1.250                   | 0.500 | <b>7820399</b>                                       | Right Hand       | 2                   | 1,765                                    | 11,080                                 | 0.00                | 1.250                 | 1.050          | 96              | 3.77         |
| 1.500                   | 0.200 | <b>7820375</b>                                       | Right Hand       | 4                   | 4,745                                    | 45,073                                 | 0.00                | 1.500                 | 1.349          | 120             | 5.18         |
| 1.500                   | 0.250 | <b>7820965</b>                                       | Right Hand       | 4                   | 4,250                                    | 27,250                                 | 0.00                | 1.500                 | 1.333          | 120             | 5.18         |
| 1.500                   | 0.500 | <b>7820401</b>                                       | Right Hand       | 2                   | 5,075                                    | 35,770                                 | 0.00                | 1.500                 | 1.236          | 120             | 4.79         |
| 1.750                   | 0.200 | <b>5700979</b>                                       | Right Hand       | 4                   | 4,464                                    | 47,446                                 | 0.00                | 1.750                 | 1.615          | 96              | 7.56         |
| 2.000                   | 0.200 | <b>7820402</b>                                       | Right Hand       | 6                   | 6,181                                    | 65,903                                 | 0.00                | 2.000                 | 1.849          | 120             | 9.81         |
| 2.250                   | 0.500 | <b>7820484</b>                                       | Right Hand       | 2                   | 20,160                                   | 108,325                                | 0.00                | 2.250                 | 1.858          | 120             | 10.87        |
| 2.500                   | 0.250 | <b>7820483</b>                                       | Right Hand       | 6                   | 8,945                                    | 93,165                                 | 0.00                | 2.500                 | 2.333          | 120             | 15.46        |

(1) All Precision Plus product is sold in matched sets as ball screw and nut assemblies.

(2) Dimensional information on bearing supports and standard end machining is available on page 154.

(3) Information on required lubrication is on page 233.

## Precision Plus Ball Screws — Inch Series

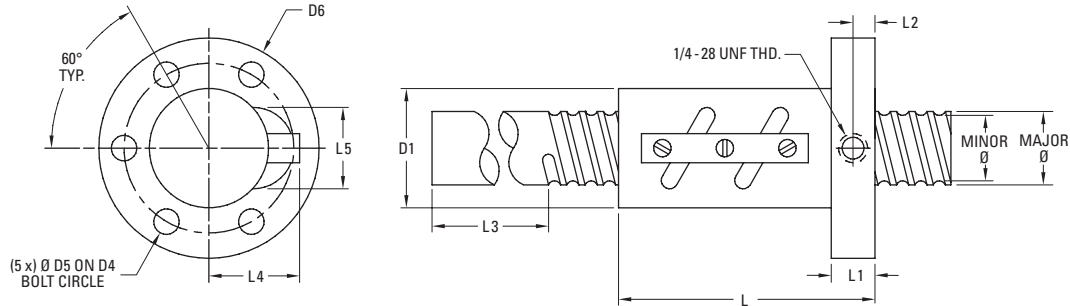

| Nominal Diameter (size) | Lead  | Nut Specifications |       |       |       |       |       |       |       |           |           |            |               |
|-------------------------|-------|--------------------|-------|-------|-------|-------|-------|-------|-------|-----------|-----------|------------|---------------|
|                         |       | D1                 | D4    | D5    | D6    | L     | L1    | L2    | L3    | L4 (max.) | L5 (max.) | Nut Weight | Ball Diameter |
| (in.)                   | (in.) | (in.)              | (in.) | (in.) | (in.) | (in.) | (in.) | (in.) | (in.) | (in.)     | (in.)     | (lb)       | (in.)         |
| 0.631                   | 0.200 | 1.130              | 1.562 | 0.281 | 2.000 | 2.200 | 0.375 | 0.200 | 2.750 | 0.849     | 0.710     | 0.66       | 0.125         |
| 0.750                   | 0.200 | 1.370              | 1.875 | 0.281 | 2.320 | 3.000 | 0.500 | 0.312 | 2.750 | 0.996     | 0.855     | 1.26       | 0.141         |
| 0.875                   | 0.200 | 1.250              | 1.750 | 0.281 | 2.250 | 3.000 | 0.500 | 0.312 | 2.750 | 0.891     | 1.024     | 0.92       | 0.125         |
| 1.000                   | 0.200 | 1.620              | 2.250 | 0.281 | 2.750 | 3.000 | 0.500 | 0.312 | 3.750 | 1.042     | 1.134     | 1.63       | 0.125         |
| 1.000                   | 0.250 | 1.685              | 2.250 | 0.344 | 2.875 | 3.370 | 0.500 | 0.312 | 3.750 | 1.100     | 1.203     | 1.98       | 0.156         |
| 1.150                   | 0.200 | 1.685              | 2.280 | 0.344 | 2.875 | 3.000 | 0.500 | 0.312 | 3.750 | 1.067     | 1.287     | 1.61       | 0.125         |
| 1.250                   | 0.200 | 1.645              | 2.312 | 0.344 | 2.770 | 3.000 | 0.500 | 0.312 | 3.750 | 1.109     | 1.248     | 1.31       | 0.125         |
| 1.250                   | 0.200 | 1.650              | 2.312 | 0.344 | 2.770 | 3.000 | 0.500 | 0.312 | 3.750 | 1.109     | 1.248     | 1.31       | 0.125         |
| 1.250                   | 0.500 | 1.990              | 3.124 | 0.406 | 3.865 | 3.580 | 0.625 | 0.410 | 3.750 | 1.356     | 1.531     | 3.43       | 0.188         |
| 1.500                   | 0.200 | 2.020              | 2.750 | 0.344 | 3.500 | 5.000 | 0.625 | 0.375 | 3.750 | 1.273     | 1.758     | 3.17       | 0.141         |
| 1.500                   | 0.250 | 2.020              | 2.750 | 0.344 | 3.500 | 5.000 | 0.625 | 0.375 | 3.750 | 1.290     | 1.520     | 3.17       | 0.156         |
| 1.500                   | 0.500 | 2.250              | 3.125 | 0.406 | 3.875 | 4.625 | 0.625 | 0.410 | 3.750 | 1.575     | 1.900     | 4.27       | 0.250         |
| 1.750                   | 0.200 | 2.265              | 3.250 | 0.406 | 4.000 | 5.000 | 0.625 | 0.375 | 4.750 | 1.352     | 1.878     | 3.81       | 0.125         |
| 2.000                   | 0.200 | 2.500              | 3.250 | 0.406 | 4.000 | 5.750 | 0.700 | 0.438 | 4.750 | 1.550     | 1.900     | 4.39       | 0.141         |
| 2.250                   | 0.500 | 3.375              | 4.375 | 0.656 | 5.375 | 8.125 | 1.250 | 0.812 | 4.750 | 2.259     | 2.535     | 16.29      | 0.375         |
| 2.500                   | 0.250 | 3.375              | 4.000 | 0.344 | 4.625 | 6.250 | 0.750 | 0.500 | 4.750 | 2.010     | 2.609     | 8.81       | 0.156         |

**NOTES:**

A large grid of graph paper for taking notes, consisting of 30 columns and 40 rows of small squares.



# Metric Ball Screws



## Table of Contents

| <b>Description</b>                                    | <b>Page</b> |
|---|-------------|
| Product Overview .....                                | 106         |
| Miniature Rolled Ball Screws — Metric Series .....    | 113         |
| Thomson NEFF Rolled Ball Screws — Metric Series ..... | 119         |
| Precision Plus Ball Screws —Metric Series .....       | 135         |

Need a quote or have a question about an application?  
Contact us in North America at:

Phone: 540-633-3549

Fax: 540-639-4162

Email: [thomson@thomsonlinear.com](mailto:thomson@thomsonlinear.com)

## Metric Ball Screws Product Overview

### Superior performance for today's most stringent positioning requirements.

Thomson has a wide range of internal return metric ball screw products, featuring four distinct product families — Miniature, Thomson NEFF and Precision Plus. Each family is designed to meet unique application requirements.

#### Miniature Rolled Ball Screws (page 113)

Miniature Rolled Ball Screw Assemblies are an efficient, cost-effective solution in a small envelope. Ball screw assemblies range from 4mm to 14mm in diameter, with standard lead accuracies of 52 microns/300mm. Miniature Rolled Ball Screws are ideal for laboratory, semiconductor, and medical applications.

Miniature ball screws are available in two nut styles.



#### Precision Plus Ball Screws (page 135)

Precision Plus Ball Screw Assemblies are our highest precision product, with standard lead accuracies of 12 microns/300mm. These ball screw assemblies feature our FL-style ball nut, precisely preloaded to customer specifications. This unique nut design provides high repeatability and high stiffness for the most demanding ball screw applications. Each nut comes standard with an integral plastic wiper to protect against chips and other debris. Precision Plus Ball Screws are ideal for applications requiring high repeatability and high stiffness (e.g., high precision machine tool).

Precision Plus screws are available with our FL style nut.



#### Thomson NEFF Rolled Ball Screws (page 119)

Thomson NEFF Rolled Ball Screw Assemblies are designed and manufactured to provide high level performance at an affordable price. Ball screws are manufactured using Thomson's patented, German-engineered Precision Screw Forming (PST) Technology, which provides high accuracy (23 microns/300mm standard) with the manufacturing efficiency of rolled processes. Ball Screw Assemblies are available in a wide range of diameters, leads, and nut styles - all designed to provide quiet, smooth running, and efficient performance. Ball nuts include one of three unique ball return systems (depending on the diameter and lead of the screw used) providing perfect guidance, low wear, and smooth running performance. Thomson NEFF Rolled Ball Screw Assemblies are ideal for machining centers, factory automation, packaging, injection molding, wood working, water jet cutting, electronic assembly, and medical applications.

Thomson NEFF ball screws are available in seven nut styles.



## Metric Ball Screws Product Overview

An overview of ball screw sizes available within each product family is shown below. Refer to individual product family sections for additional details.

### Miniature Rolled Ball Screws — Product Availability (page 113)

|      | 1mm | 2mm | 2.5mm | 3mm | 4mm | 5mm | 6mm | 8mm | 10mm | 12mm | 15mm | 20mm |
|------|-----|-----|-------|-----|-----|-----|-----|-----|------|------|------|------|
| 4mm  | ●   |     |       |     |     |     |     |     |      |      |      |      |
| 5mm  |     |     |       |     | ●   |     |     |     |      |      |      |      |
| 6mm  | ●   | ●   |       |     |     |     | ●   |     |      |      |      |      |
| 8mm  | ●   | ●   | ●     | ●   |     | ●   |     | ●   |      | ●    |      |      |
| 10mm |     | ●   |       | ●   | ●   |     |     |     | ●    |      | ●    | ●    |
| 12mm |     | ●   |       | ●   |     |     |     |     |      |      |      |      |
| 13mm |     |     |       |     |     |     |     |     |      | ●    |      | ●    |
| 14mm |     | ●   |       | ●   | ●   |     |     |     |      |      |      |      |

### Thomson NEFF Rolled Ball Screws — Product Availability (page 119)

|      | 1mm | 2mm | 4mm | 5mm | 6mm | 8mm | 10mm | 12mm | 15mm | 20mm | 25mm | 32mm | 40mm | 50mm |
|------|-----|-----|-----|-----|-----|-----|------|------|------|------|------|------|------|------|
| 12mm |     |     | ●   | ●   |     |     | ●    |      |      |      |      |      |      |      |
| 16mm |     |     |     | ●   |     |     | ●    |      |      |      |      |      |      |      |
| 20mm |     |     |     | ●   |     |     |      |      |      | ●    |      |      |      | ●    |
| 25mm |     |     |     | ●   |     |     | ●    |      |      | ●    | ●    |      |      | ●    |
| 32mm |     |     |     | ●   |     |     | ●    |      |      | ●    |      | ●    | ●    |      |
| 40mm |     |     |     | ●   |     |     | ●    |      |      | ●    |      |      | ●    |      |
| 50mm |     |     |     |     |     |     | ●    |      |      | ●    |      |      |      |      |
| 63mm |     |     |     |     |     |     | ●    |      |      | ●    |      |      |      |      |
| 80mm |     |     |     |     |     |     | ●    |      |      |      |      |      |      |      |

### Precision Plus Ball Screws — Product Availability\* (page 135)

|      | 1mm | 2mm | 4mm | 5mm | 6mm | 8mm | 10mm | 12mm | 15mm | 20mm | 25mm | 32mm | 40mm | 50mm |
|------|-----|-----|-----|-----|-----|-----|------|------|------|------|------|------|------|------|
| 16mm |     |     |     | ●   |     |     |      |      |      |      |      |      |      |      |
| 20mm |     |     |     | ●   |     |     |      |      |      |      |      |      |      |      |
| 25mm |     |     |     | ●   |     |     |      |      |      |      |      |      |      |      |
| 32mm |     |     |     | ●   |     |     | ●    |      |      |      |      |      |      |      |
| 40mm |     |     |     | ●   |     |     |      |      |      |      |      |      |      |      |
| 50mm |     |     |     |     |     |     | ●    |      |      |      |      |      |      |      |
| 63mm |     |     |     |     |     |     | ●    |      |      |      |      |      |      |      |

\* Additional ground ball screw sizes are available in diameters up to 200mm. Contact us for more details.

## Metric Ball Screws Product Overview

The Thomson series of metric ball screws includes two families of rolled ball screws (Miniature, Thomson NEFF) with four nut styles — Miniature, Cylindrical, Threaded and Flanged. An overview of our rolled product offering is organized by nut style, below. Refer to individual product family sections for additional details.

### Miniature Ball Nuts

**Miniature: TSI, PRM**

**Return:** Internal

**Style:** Miniature

**Mounting:** Flanged, Threaded

**Backlash:** Non-preloaded

**Thread Direction:** Right Hand

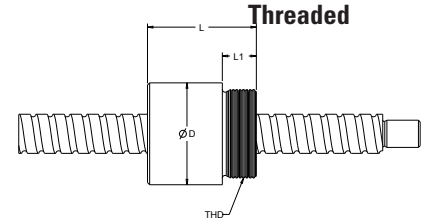
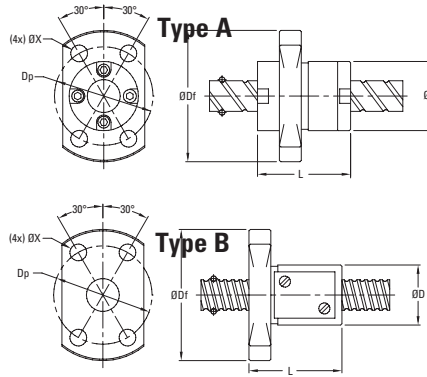

| Nominal Diameter | Lead | Dynamic Load Capacity (C <sub>am</sub> ) | Length L | Width/Diameter D | Ball Nut Form | Flange Diameter D <sub>f</sub> | Bolt Hole Circle D <sub>p</sub> | Hole Diameter X | Screw and Nut Assembly P/N | Catalog Page |
|------------------|------|--|----------|------------------|---------------|--------------------------------|---------------------------------|-----------------|----------------------------|--------------|
| (mm)             | (mm) | (kN)                                     | (mm)     | (mm)             |               | (mm)                           | (mm)                            | (mm)            |                            |              |
| 4                | 1    | 0.6                                      | 17.0     | 11.0             | Type B        | 24.0                           | 18.0                            | 3.4             | PRM0401                    | 114          |
| 5                | 4    | 0.5                                      | 22.0     | 12.0             | Type B        | 24.0                           | 18.0                            | 3.4             | PRM0504                    | 114          |
| 6                | 1    | 0.7                                      | 17.0     | 13.0             | Type B        | 26.0                           | 20.0                            | 3.4             | PRM0601                    | 114          |
| 6                | 2    | 1.6                                      | 22.0     | 16.0             | Threaded      |                                |                                 |                 | 8102-448-025               | 116          |
| 6                | 6    | 0.9                                      | 17.0     | 14.0             | Type A        | 27.0                           | 21.0                            | 3.4             | PRM0606                    | 114          |
| 8                | 1    | 0.8                                      | 17.0     | 16.0             | Type B        | 29.0                           | 23.0                            | 3.4             | PRM0801                    | 114          |
| 8                | 2    | 2.4                                      | 24.0     | 20.0             | Type B        | 37.0                           | 29.0                            | 4.5             | PRM0802                    | 114          |
| 8                | 2    | 2.3                                      | 24.0     | 18.0             | Threaded      |                                |                                 |                 | 8103-448-026               | 116          |
| 8                | 2.5  | 3.1                                      | 24.0     | 18.0             | Threaded      |                                |                                 |                 | 8103-448-027               | 116          |
| 8                | 3    | 2.7                                      | 25.0     | 18.0             | Threaded      |                                |                                 |                 | 8103-448-028               | 116          |
| 8                | 5    | 1.9                                      | 28.0     | 18.0             | Type B        | 31.0                           | 25.0                            | 3.4             | PRM0805                    | 114          |
| 8                | 8    | 2.2                                      | 20.0     | 18.0             | Type A        | 31.0                           | 25.0                            | 3.4             | PRM0808                    | 114          |
| 8                | 12   | 2.2                                      | 27.0     | 18.0             | Type A        | 31.0                           | 25.0                            | 3.4             | PRM0812                    | 114          |
| 10               | 2    | 2.7                                      | 24.0     | 23.0             | Type B        | 40.0                           | 32.0                            | 4.5             | PRM1002                    | 114          |
| 10               | 2    | 2.7                                      | 22.0     | 19.5             | Threaded      |                                |                                 |                 | 8103-448-022               | 116          |
| 10               | 3    | 6.7                                      | 29.0     | 21.0             | Threaded      |                                |                                 |                 | 8103-448-023               | 116          |
| 10               | 4    | 5.8                                      | 35.0     | 21.0             | Threaded      |                                |                                 |                 | 8103-448-029               | 116          |
| 10               | 10   | 3.3                                      | 24.0     | 23.0             | Type A        | 40.0                           | 32.0                            | 4.5             | PRM1010                    | 114          |
| 10               | 10   | 4.1                                      | 35.0     | 23.0             | Threaded      |                                |                                 |                 | 8103-448-030               | 116          |
| 10               | 15   | 3.3                                      | 33.0     | 23.0             | Type A        | 40.0                           | 32.0                            | 4.5             | PRM1015                    | 114          |
| 10               | 20   | 2.1                                      | 23.0     | 20.0             | Type A        | 37.0                           | 29.0                            | 4.5             | PRM1020                    | 114          |
| 12               | 2    | 3.0                                      | 24.0     | 25.0             | Type B        | 42.0                           | 34.0                            | 4.5             | PRM1202                    | 114          |
| 12               | 2    | 4.5                                      | 40.0     | 24.0             | Threaded      |                                |                                 |                 | 8105-448-031               | 116          |
| 12               | 3    | 9.6                                      | 40.0     | 26.0             | Threaded      |                                |                                 |                 | 8105-448-032               | 116          |
| 13               | 12   | 5.0                                      | 30.0     | 28.0             | Type A        | 45.0                           | 37.0                            | 4.5             | PRM1312                    | 114          |
| 13               | 20   | 5.0                                      | 43.0     | 28.0             | Type A        | 45.0                           | 37.0                            | 4.5             | PRM1320                    | 114          |
| 14               | 2    | 3.2                                      | 25.0     | 26.0             | Type B        | 45.0                           | 36.0                            | 5.5             | PRM1402                    | 114          |
| 14               | 3    | 6.7                                      | 35.0     | 30.0             | Threaded      |                                |                                 |                 | 8105-448-033               | 116          |
| 14               | 4    | 5.7                                      | 33.0     | 30.0             | Type B        | 49.0                           | 40.0                            | 5.5             | PRM1404                    | 114          |

## Metric Ball Screws Product Overview

### Cylindrical Ball Nuts

**Model:** ZG, KGM-D, KGM-N

**Return:** Internal

**Style:** Cylindrical

**Mounting:** Threaded

**Backlash:** Z1, Z2 and Z3

**Thread Direction:** Right Hand

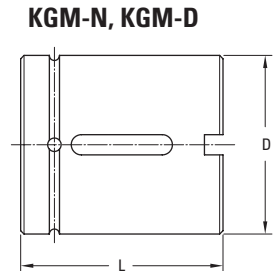
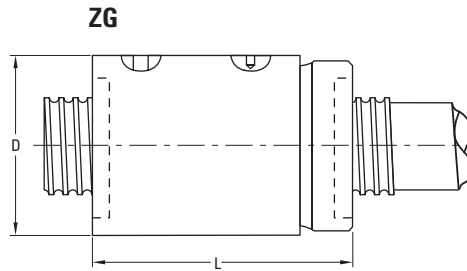

| Nominal Diameter | Lead | Dynamic Load Capacity (C <sub>am</sub> ) | Length L | Width/Diameter D | Ball Nut Form | Flange Diameter D <sub>f</sub> | Bolt Hole Circle D <sub>p</sub> | Hole Diameter X | Ball Nut | Nut P/N          | Screw P/N       | Catalog Page |
|------------------|------|--|----------|------------------|---------------|--------------------------------|---------------------------------|-----------------|----------|------------------|-----------------|--------------|
| (mm)             | (mm) | (kN)                                     | (mm)     | (mm)             |               | (mm)                           | (mm)                            | (mm)            |          |                  |                 |              |
| 12               | 4    | 3.5                                      | 34.0     | 25.0             | Threaded      | n/a                            | n/a                             | n/a             | ZG       | 7832771          | 7832770-P5      | 120          |
| 12               | 5    | 4.4                                      | 24.0     | 20.0             | Keyway        | n/a                            | n/a                             | n/a             | KGM-N    | KGM-N-1205-RH-00 | KGS-1205-023-RH | 132          |
| 12               | 10   | 4.9                                      | 27.5     | 24.0             | Keyway        | n/a                            | n/a                             | n/a             | KGM-D    | KGM-D-1210-RH-00 | KGS-1210-023-RH | 130          |
| 16               | 5    | 9.3                                      | 34.0     | 28.0             | Keyway        | n/a                            | n/a                             | n/a             | KGM-D    | KGM-D-1605-RH-EE | KGS-1605-023-RH | 130          |
| 16               | 5    | 12.1                                     | 57.5     | 32.0             | Threaded      | n/a                            | n/a                             | n/a             | ZG       | 7832778          | 7832776-P5      | 120          |
| 16               | 10   | 15.4                                     | 50.0     | 28.0             | Keyway        | n/a                            | n/a                             | n/a             | KGM-D    | KGM-D-1610-RH-EE | KGS-1610-023-RH | 130          |
| 20               | 5    | 10.5                                     | 34.0     | 36.0             | Keyway        | n/a                            | n/a                             | n/a             | KGM-D    | KGM-D-2005-RH-EE | KGS-2005-023-RH | 130          |
| 20               | 5    | 10.5                                     | 34.0     | 32.0             | Keyway        | n/a                            | n/a                             | n/a             | KGM-N    | KGM-N-2005-RH-EE | KGS-2005-023-RH | 132          |
| 20               | 5    | 14.8                                     | 57.5     | 38.0             | Threaded      | n/a                            | n/a                             | n/a             | ZG       | 7832781          | 7832779-P5      | 120          |
| 20               | 20   | 11.6                                     | 30.0     | 35.0             | Keyway        | n/a                            | n/a                             | n/a             | KGM-N    | KGM-N-2020-RH-EE | KGS-2020-023-RH | 132          |
| 20               | 50   | 13.0                                     | 56.0     | 35.0             | Keyway        | n/a                            | n/a                             | n/a             | KGM-N    | KGM-N-2050-RH-EE | KGS-2050-023-RH | 132          |
| 25               | 5    | 12.3                                     | 34.0     | 40.0             | Keyway        | n/a                            | n/a                             | n/a             | KGM-D    | KGM-D-2505-RH-EE | KGS-2505-023-RH | 130          |
| 25               | 5    | 12.3                                     | 34.0     | 38.0             | Keyway        | n/a                            | n/a                             | n/a             | KGM-N    | KGM-N-2505-RH-EE | KGS-2505-023-RH | 132          |
| 25               | 5    | 20.4                                     | 63.5     | 42.0             | Threaded      | n/a                            | n/a                             | n/a             | ZG       | 7832788          | 7832786-P5      | 120          |
| 25               | 10   | 13.2                                     | 45.0     | 40.0             | Keyway        | n/a                            | n/a                             | n/a             | KGM-D    | KGM-D-2510-RH-EE | KGS-2510-023-RH | 130          |
| 25               | 10   | 19.9                                     | 61.0     | 42.0             | Threaded      | n/a                            | n/a                             | n/a             | ZG       | 7832792          | 7832790-P5      | 120          |
| 25               | 20   | 13.0                                     | 35.0     | 40.0             | Keyway        | n/a                            | n/a                             | n/a             | KGM-D    | KGM-D-2520-RH-EE | KGS-2520-023-RH | 130          |
| 25               | 25   | 16.7                                     | 35.0     | 40.0             | Keyway        | n/a                            | n/a                             | n/a             | KGM-D    | KGM-D-2525-RH-EE | KGS-2525-023-RH | 130          |
| 25               | 50   | 15.4                                     | 58.0     | 40.0             | Keyway        | n/a                            | n/a                             | n/a             | KGM-D    | KGM-D-2550-RH-EE | KGS-2550-023-RH | 130          |
| 32               | 5    | 21.5                                     | 45.0     | 50.0             | Keyway        | n/a                            | n/a                             | n/a             | KGM-D    | KGM-D-3205-RH-EE | KGS-3205-023-RH | 130          |
| 32               | 5    | 21.5                                     | 45.0     | 45.0             | Keyway        | n/a                            | n/a                             | n/a             | KGM-N    | KGM-N-3205-RH-EE | KGS-3205-023-RH | 132          |
| 32               | 5    | 23.3                                     | 65.5     | 52.0             | Threaded      | n/a                            | n/a                             | n/a             | ZG       | 7832797          | 7832795-P5      | 120          |
| 32               | 10   | 33.4                                     | 60.0     | 53.0             | Keyway        | n/a                            | n/a                             | n/a             | KGM-N    | KGM-N-3210-RH-EE | KGS-3210-023-RH | 132          |
| 32               | 10   | 33.8                                     | 85.0     | 52.0             | Threaded      | n/a                            | n/a                             | n/a             | ZG       | 7832800          | 7832798-P5      | 120          |
| 32               | 20   | 29.7                                     | 70.0     | 53.0             | Keyway        | n/a                            | n/a                             | n/a             | KGM-N    | KGM-N-3220-RH-EE | KGS-3220-023-RH | 132          |
| 32               | 40   | 14.9                                     | 45.0     | 53.0             | Keyway        | n/a                            | n/a                             | n/a             | KGM-N    | KGM-N-3240-RH-EE | KGS-3240-023-RH | 132          |
| 40               | 5    | 23.8                                     | 45.0     | 63.0             | Keyway        | n/a                            | n/a                             | n/a             | KGM-D    | KGM-D-4005-RH-EE | KGS-4005-023-RH | 130          |
| 40               | 5    | 23.8                                     | 45.0     | 53.0             | Keyway        | n/a                            | n/a                             | n/a             | KGM-N    | KGM-N-4005-RH-EE | KGS-4005-023-RH | 132          |
| 40               | 5    | 26.3                                     | 67.5     | 58.0             | Threaded      | n/a                            | n/a                             | n/a             | ZG       | 7832806          | 7832804-P5      | 120          |
| 40               | 10   | 38.0                                     | 60.0     | 63.0             | Keyway        | n/a                            | n/a                             | n/a             | KGM-D    | KGM-D-4010-RH-EE | KGS-4010-023-RH | 130          |
| 40               | 10   | 78.6                                     | 105.5    | 65.0             | Threaded      | n/a                            | n/a                             | n/a             | ZG       | 7832810          | 7832808-P5      | 120          |
| 40               | 20   | 33.3                                     | 70.0     | 63.0             | Keyway        | n/a                            | n/a                             | n/a             | KGM-D    | KGM-D-4020-RH-EE | KGS-4020-023-RH | 134          |
| 40               | 20   | 34.2                                     | 83.0     | 65.0             | Threaded      | n/a                            | n/a                             | n/a             | ZG       | 7833723          | 7832811-P5      | 120          |
| 40               | 40   | 35.0                                     | 85.0     | 63.0             | Keyway        | n/a                            | n/a                             | n/a             | KGM-D    | KGM-D-4040-RH-EE | KGS-4040-023-RH | 130          |
| 50               | 10   | 68.7                                     | 82.0     | 72.0             | Keyway        | n/a                            | n/a                             | n/a             | KGM-N    | KGM-N-5010-RH-EE | KGS-5010-023-RH | 132          |
| 50               | 10   | 82.0                                     | 82.0     | 75.0             | Keyway        | n/a                            | n/a                             | n/a             | KGM-D    | KGM-D-5010-RH-EE | KGS-5010-023-RH | 130          |
| 50               | 10   | 97.8                                     | 118.0    | 78.0             | Threaded      | n/a                            | n/a                             | n/a             | ZG       | 7832819          | 7832817-P5      | 120          |
| 50               | 20   | 60.0                                     | 82.0     | 85.0             | Keyway        | n/a                            | n/a                             | n/a             | KGM-N    | KGM-N-5020-RH-EE | KGS-5020-023-RH | 132          |
| 63               | 10   | 76.0                                     | 82.0     | 85.0             | Keyway        | n/a                            | n/a                             | n/a             | KGM-N    | KGM-N-6310-RH-EE | KGS-6310-023-RH | 132          |
| 63               | 10   | 90.0                                     | 82.0     | 90.0             | Keyway        | n/a                            | n/a                             | n/a             | KGM-D    | KGM-D-6310-RH-EE | KGS-6310-023-RH | 130          |
| 63               | 10   | 109.7                                    | 118.0    | 92.0             | Threaded      | n/a                            | n/a                             | n/a             | ZG       | 7832824          | 7832822-P5      | 120          |
| 80               | 10   | 86.3                                     | 82.0     | 105.0            | Keyway        | n/a                            | n/a                             | n/a             | KGM-N    | KGM-N-8010-RH-EE | KGS-8010-023-RH | 132          |
| 80               | 10   | 121.9                                    | 126.0    | 120.0            | Threaded      | n/a                            | n/a                             | n/a             | ZG       | 7832829          | 7832827-T7      | 120          |

# Metric Ball Screws Product Overview

## Flanged Ball Nuts

**Model:** FK, FH, KGF-D  
**Return:** Internal  
**Style:** Flanged  
**Mounting:** Flanged  
**Backlash:** Z1, Z2 and Z3  
**Thread Direction:** Right Hand

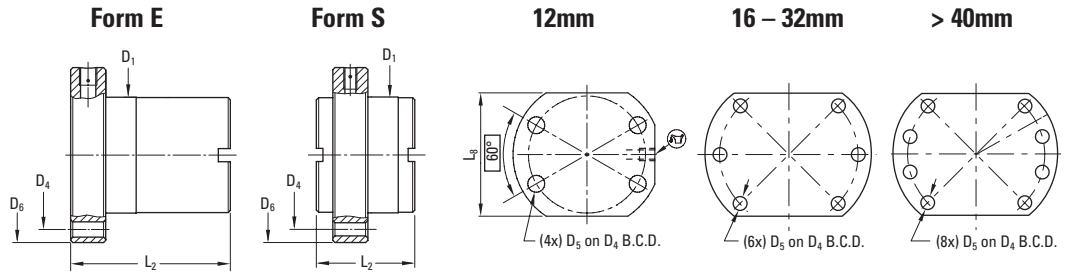

Note: KGF-D 2525 and 4040 models have round flanges.

| Nominal Diameter | Lead | Dynamic Load Capacity (C <sub>am</sub> ) | Length L <sub>2</sub> | Width/Diameter D <sub>1</sub> | Ball Nut Form | Flange Diameter D <sub>6</sub> | Bolt Hole Circle D <sub>4</sub> | Hole Diameter D <sub>5</sub> | Ball Nut | Nut P/N          | Screw P/N       | Catalog Page |
|------------------|------|--|-----------------------|-------------------------------|---------------|--------------------------------|---------------------------------|------------------------------|----------|------------------|-----------------|--------------|
| (mm)             | (mm) | (kN)                                     | (mm)                  | (mm)                          |               | (mm)                           | (mm)                            | (mm)                         |          |                  |                 |              |
| 12               | 10   | 4.9                                      | 27.5                  | 24.0                          | Form S        | 40.0                           | 32.0                            | 4.5                          | KGF-D    | KGF-D-1210-RH-00 | KGS-1210-023-RH | 126          |
| 16               | 5    | 9.5                                      | 48.5                  | 28.0                          | Form S        | 48.0                           | 38.0                            | 5.5                          | FK       | 7832777          | 7832776-P5      | 122          |
| 16               | 5    | 9.3                                      | 42.0                  | 28.0                          | Form E        | 48.0                           | 38.0                            | 5.5                          | KGF-D    | KGF-D-1605-RH-EE | KGS-1605-023-RH | 126          |
| 16               | 10   | 15.4                                     | 55.0                  | 28.0                          | Form E        | 48.0                           | 38.0                            | 5.5                          | KGF-D    | KGF-D-1610-RH-EE | KGS-1610-023-RH | 126          |
| 20               | 5    | 11.5                                     | 48.5                  | 36.0                          | Form S        | 58.0                           | 47.0                            | 6.6                          | FK       | 7832780          | 7832779-P5      | 122          |
| 20               | 5    | 10.5                                     | 42.0                  | 36.0                          | Form E        | 58.0                           | 47.0                            | 6.6                          | KGF-D    | KGF-D-2005-RH-EE | KGS-2005-023-RH | 126          |
| 20               | 20   | 10.8                                     | 36.0                  | 36.0                          | Form S        | 58.0                           | 47.0                            | 6.6                          | FH       | 7832784          | 7832783-P5      | 122          |
| 25               | 5    | 13.1                                     | 49.0                  | 40.0                          | Form S        | 62.0                           | 51.0                            | 6.6                          | FK       | 7832787          | 7832786-P5      | 122          |
| 25               | 5    | 12.3                                     | 42.0                  | 40.0                          | Form E        | 62.0                           | 51.0                            | 6.6                          | KGF-D    | KGF-D-2505-RH-EE | KGS-2505-023-RH | 126          |
| 25               | 10   | 24.7                                     | 51.0                  | 40.0                          | Form S        | 62.0                           | 51.0                            | 6.6                          | FH       | 7832791          | 7832790-P5      | 122          |
| 25               | 10   | 13.2                                     | 55.0                  | 40.0                          | Form E        | 62.0                           | 51.0                            | 6.6                          | KGF-D    | KGF-D-2510-RH-EE | KGS-2510-023-RH | 126          |
| 25               | 20   | 13.0                                     | 35.0                  | 40.0                          | Form S        | 62.0                           | 51.0                            | 6.6                          | KGF-D    | KGF-D-2520-RH-EE | KGS-2520-023-RH | 126          |
| 25               | 25   | 13.1                                     | 39.0                  | 40.0                          | Form S        | 62.0                           | 51.0                            | 6.6                          | FH       | 7832794          | 7832793-P5      | 122          |
| 25               | 25   | 16.7                                     | 35.0                  | 40.0                          | Form S        | 62.0                           | 51.0                            | 6.6                          | KGF-D    | KGF-D-2525-RH-EE | KGS-2525-023-RH | 126          |
| 25               | 50   | 15.4                                     | 58.0                  | 40.0                          | Form S        | 62.0                           | 51.0                            | 6.6                          | KGF-D    | KGF-D-2550-RH-EE | KGS-2550-023-RH | 126          |
| 32               | 5    | 19.3                                     | 57.0                  | 50.0                          | Form S        | 80.0                           | 65.0                            | 9.0                          | FK       | 7832796          | 7832795-P5      | 122          |
| 32               | 5    | 21.5                                     | 55.0                  | 50.0                          | Form E        | 80.0                           | 65.0                            | 9.0                          | KGF-D    | KGF-D-3205-RH-EE | KGS-3205-023-RH | 126          |
| 32               | 10   | 26.4                                     | 73.0                  | 50.0                          | Form S        | 80.0                           | 65.0                            | 9.0                          | FK       | 7832799          | 7832798-P5      | 122          |
| 32               | 10   | 33.4                                     | 69.0                  | 53.0                          | Form E        | 80.0                           | 65.0                            | 9.0                          | KGF-D    | KGF-D-3210-RH-EE | KGS-3210-023-RH | 126          |
| 32               | 20   | 47.2                                     | 83.0                  | 56.0                          | Form S        | 86.0                           | 71.0                            | 9.0                          | FH       | 7832803          | 7832802-P5      | 122          |
| 32               | 20   | 29.7                                     | 80.0                  | 53.0                          | Form E        | 80.0                           | 65.0                            | 9.0                          | KGF-D    | KGF-D-3220-RH-EE | KGS-3220-023-RH | 126          |
| 32               | 32   | 19.7                                     | 42.0                  | 56.0                          | Form S        | 86.0                           | 71.0                            | 9.0                          | FH       | 7833300          | 7833301-P5      | 122          |
| 32               | 32   | 18.0                                     | 42.0                  | 50.0                          | Form S        | 80.0                           | 65.0                            | 9.0                          | KGF-D    | KGF-D-3232-RH-EE | KGS-3232-023-RH | 126          |
| 40               | 5    | 26.3                                     | 66.0                  | 63.0                          | Form S        | 93.0                           | 78.0                            | 9.0                          | FK       | 7832805          | 7832804-P5      | 122          |
| 40               | 5    | 23.8                                     | 57.0                  | 63.0                          | Form E        | 93.0                           | 78.0                            | 9.0                          | KGF-D    | KGF-D-4005-RH-EE | KGS-4005-023-RH | 126          |
| 40               | 10   | 64.9                                     | 88.5                  | 63.0                          | Form S        | 93.0                           | 78.0                            | 9.0                          | FK       | 7832809          | 7832808-P5      | 122          |
| 40               | 10   | 38.0                                     | 71.0                  | 63.0                          | Form E        | 93.0                           | 78.0                            | 9.0                          | KGF-D    | KGF-D-4010-RH-EE | KGS-4010-023-RH | 126          |
| 40               | 20   | 52.2                                     | 83.0                  | 63.0                          | Form S        | 93.0                           | 78.0                            | 9.0                          | FH       | 7832812          | 7832811-P5      | 122          |
| 40               | 20   | 33.3                                     | 80.0                  | 63.0                          | Form E        | 93.0                           | 78.0                            | 9.0                          | KGF-D    | KGF-D-4020-RH-EE | KGS-4020-023-RH | 126          |
| 40               | 40   | 59.7                                     | 104.0                 | 70.0                          | Form S        | 100.0                          | 85.0                            | 9.0                          | FH       | 7832815          | 7832814-P5      | 122          |
| 40               | 40   | 35.0                                     | 85.0                  | 63.0                          | Form S        | 93.0                           | 78.0                            | 9.0                          | KGF-D    | KGF-D-4040-RH-EE | KGS-4040-023-RH | 126          |
| 50               | 10   | 66.4                                     | 92.0                  | 75.0                          | Form S        | 110.0                          | 93.0                            | 11.0                         | FK       | 7832818          | 7832817-P5      | 122          |
| 50               | 10   | 68.7                                     | 95.0                  | 75.0                          | Form E        | 110.0                          | 93.0                            | 11.0                         | KGF-D    | KGF-D-5010-RH-EE | KGS-5010-023-RH | 126          |
| 50               | 20   | 78.8                                     | 85.0                  | 75.0                          | Form S        | 110.0                          | 93.0                            | 11.0                         | FH       | 7832821          | 7832820-P5      | 122          |
| 50               | 20   | 60.0                                     | 95.0                  | 85.0                          | Form E        | 125.0                          | 103.0                           | 11.0                         | KGF-D    | KGF-D-5020-RH-EE | KGS-5020-023-RH | 126          |
| 63               | 10   | 76.0                                     | 97.0                  | 90.0                          | Form E        | 125.0                          | 108.0                           | 11.0                         | KGF-D    | KGF-D-6310-RH-EE | KGS-6310-023-RH | 126          |
| 63               | 10   | 93.8                                     | 103.5                 | 90.0                          | Form S        | 125.0                          | 108.0                           | 11.0                         | FK       | 7832823          | 7832822-P5      | 122          |
| 63               | 20   | 103.1                                    | 86.0                  | 95.0                          | Form S        | 135.0                          | 115.0                           | 13.5                         | FK       | 7832826          | 7832825-P5      | 122          |
| 80               | 10   | 121.9                                    | 121.0                 | 105.0                         | Form S        | 145.0                          | 125.0                           | 13.5                         | FK       | 7832828          | 7832827-T7      | 122          |

## Metric Ball Screws Product Overview

### Flanged Ball Nuts

**Model:** KGF-N

**Return:** Internal

**Style:** Flanged

**Mounting:** Flanged

**Backlash:** Z1, Z2 and Z3

**Thread Direction:** Right Hand

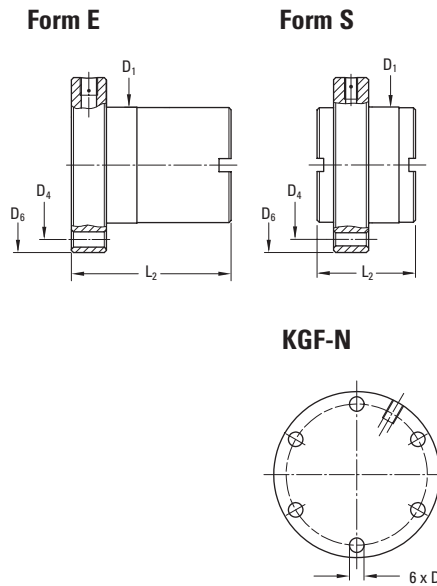

| Nominal Diameter | Lead | Dynamic Load Capacity ( $C_{am}$ ) | Length $L_2$ | Width/Diameter $D_1$ | Ball Nut Form | Flange Diameter $D_6$ | Bolt Hole Circle $D_4$ | Hole Diameter $D_5$ | Ball Nut | Nut P/N          | Screw P/N       | Catalog Page |
|------------------|------|------------------------------------|--------------|----------------------|---------------|-----------------------|------------------------|---------------------|----------|------------------|-----------------|--------------|
| (mm)             | (mm) | (kN)                               | (mm)         | (mm)                 |               | (mm)                  | (mm)                   | (mm)                |          |                  |                 |              |
| 16               | 5    | 9.3                                | 44.0         | 28.0                 | Form E        | 48.0                  | 38.0                   | 5.5                 | KGF-N    | KGF-N-1605-RH-EE | KGS-1605-050-RH | 128          |
| 20               | 5    | 10.5                               | 44.0         | 32.0                 | Form E        | 55.0                  | 45.0                   | 7.0                 | KGF-N    | KGF-N-2005-RH-EE | KGS-2005-050-RH | 128          |
| 20               | 20   | 11.6                               | 30.0         | 35.0                 | Form S        | 62.0                  | 50.0                   | 7.0                 | KGF-N    | KGF-N-2020-RH-EE | KGS-2020-050-RH | 128          |
| 20               | 50   | 13.0                               | 56.0         | 35.0                 | Form S        | 62.0                  | 50.0                   | 7.0                 | KGF-N    | KGF-N-2050-RH-EE | KGS-2050-050-RH | 128          |
| 25               | 5    | 12.3                               | 46.0         | 38.0                 | Form E        | 62.0                  | 50.0                   | 7.0                 | KGF-N    | KGF-N-2505-RH-EE | KGS-2505-050-RH | 128          |
| 32               | 5    | 21.5                               | 59.0         | 45.0                 | Form E        | 70.0                  | 58.0                   | 7.0                 | KGF-N    | KGF-N-3205-RH-EE | KGS-3205-050-RH | 128          |
| 32               | 10   | 33.4                               | 73.0         | 53.0                 | Form E        | 80.0                  | 68.0                   | 7.0                 | KGF-N    | KGF-N-3210-RH-EE | KGS-3210-050-RH | 128          |
| 32               | 40   | 14.9                               | 45.0         | 53.0                 | Form S        | 80.0                  | 68.0                   | 7.0                 | KGF-N    | KGF-N-3240-RH-EE | KGS-3240-050-RH | 128          |
| 40               | 5    | 23.8                               | 59.0         | 53.0                 | Form E        | 80.0                  | 68.0                   | 7.0                 | KGF-N    | KGF-N-4005-RH-EE | KGS-4005-050-RH | 128          |
| 40               | 10   | 38.0                               | 73.0         | 63.0                 | Form E        | 95.0                  | 78.0                   | 9.0                 | KGF-N    | KGF-N-4010-RH-EE | KGS-4010-050-RH | 128          |
| 50               | 10   | 68.7                               | 97.0         | 72.0                 | Form E        | 110.0                 | 90.0                   | 11.0                | KGF-N    | KGF-N-5010-RH-EE | KGS-5010-050-RH | 128          |
| 63               | 10   | 76.0                               | 99.0         | 85.0                 | Form E        | 125.0                 | 105.0                  | 11.0                | KGF-N    | KGF-N-6310-RH-EE | KGS-6310-050-RH | 128          |
| 80               | 10   | 86.3                               | 101.0        | 105.0                | Form E        | 145.0                 | 125.0                  | 14.0                | KGF-N    | KGF-N-8010-RH-EE | KGS-8010-023-RH | 128          |

**NOTES:**

A large grid of graph paper for taking notes, consisting of 30 columns and 40 rows of small squares.



## Miniature Rolled Ball Screws — Metric Series



**Miniature Rolled Ball Screw Assemblies** are an efficient, cost-effective solution in a small envelope. Ball screw assemblies range from 4mm to 14mm in diameter, with standard lead accuracies of 52 microns/300mm. Miniature Rolled Ball Screws are ideal for laboratory, semiconductor, and medical applications.

Need a quote or have a question about an application?  
Contact us in North America at:

Phone: 540-633-3549

Fax: 540-639-4162

Email: [thomson@thomsonlinear.com](mailto:thomson@thomsonlinear.com)

## Miniature Rolled Ball Screws — PRM Series

4mm to 14mm Diameter, Lead Accuracy:  $\pm 52\mu\text{m}/300\text{mm}$



**Type A**



**Type B**

**Non-Preloaded, Rolled Ball Screw Assemblies**

- Cost-effective solution in a small envelope, ideal for use in small spaces
- Clearance held to max .02mm
- Two nut styles (Type A & B) provide optimum performance in low and high lead assemblies

| Nominal Diameter (size) | Lead | Nut Type | Ball Screw and Nut Assembly P/N <sup>(1)</sup> | Suggested Bearing Size | Performance Data      |       |                      |       |                     |                |             |
|-------------------------|------|----------|--|------------------------|-----------------------|-------|----------------------|-------|---------------------|----------------|-------------|
|                         |      |          |  |                        | Dynamic Load Capacity |       | Static Load Capacity |       | Max. Axial Backlash | Minor Diameter | Max. Length |
| (mm)                    | (mm) |          |  | (mm)                   | (kN)                  | (lbf) | (kN)                 | (lbf) | (mm)                | (mm)           | (mm)        |
| 4                       | 1    | B        | <b>PRM0401</b>                                 | N/A                    | 0.6                   | 126   | 0.8                  | 178   | 0.02                | 3.3            | 100         |
| 5                       | 4    | B        | <b>PRM0504</b>                                 | N/A                    | 0.5                   | 106   | 0.7                  | 162   | 0.02                | 4.3            | 220         |
| 6                       | 1    | B        | <b>PRM0601</b>                                 | 4                      | 0.7                   | 153   | 1.2                  | 270   | 0.02                | 5.3            | 265         |
| 6                       | 6    | A        | <b>PRM0606</b>                                 | 4                      | 0.9                   | 196   | 1.5                  | 326   | 0.02                | 5.2            | 265         |
| 8                       | 1    | B        | <b>PRM0801</b>                                 | 6                      | 0.8                   | 175   | 1.7                  | 371   | 0.02                | 7.3            | 360         |
| 8                       | 2    | B        | <b>PRM0802</b>                                 | 6                      | 2.4                   | 540   | 4.1                  | 922   | 0.02                | 6.6            | 360         |
| 8                       | 5    | B        | <b>PRM0805</b>                                 | 6                      | 1.9                   | 416   | 3.0                  | 674   | 0.02                | 6.6            | 360         |
| 8                       | 8    | A        | <b>PRM0808</b>                                 | 6                      | 2.2                   | 495   | 3.8                  | 854   | 0.02                | 6.7            | 360         |
| 8                       | 12   | A        | <b>PRM0812</b>                                 | 6                      | 2.2                   | 495   | 4.0                  | 899   | 0.02                | 6.7            | 360         |
| 10                      | 2    | B        | <b>PRM1002</b>                                 | 6                      | 2.7                   | 607   | 5.3                  | 1,191 | 0.02                | 8.6            | 355         |
| 10                      | 10   | A        | <b>PRM1010</b>                                 | 6                      | 3.3                   | 742   | 5.9                  | 1,326 | 0.02                | 8.4            | 405         |
| 10                      | 15   | A        | <b>PRM1015</b>                                 | 6                      | 3.3                   | 742   | 6.4                  | 1,439 | 0.02                | 8.4            | 405         |
| 10                      | 20   | A        | <b>PRM1020</b>                                 | 6                      | 2.1                   | 472   | 4.0                  | 899   | 0.02                | 8.7            | 405         |
| 12                      | 2    | B        | <b>PRM1202</b>                                 | 8                      | 3.0                   | 674   | 6.4                  | 1,439 | 0.02                | 10.6           | 395         |
| 13                      | 12   | A        | <b>PRM1312</b>                                 | 8                      | 5.0                   | 1,124 | 9.9                  | 2,226 | 0.02                | 11.0           | 700         |
| 13                      | 20   | A        | <b>PRM1320</b>                                 | 8                      | 5.0                   | 1,124 | 10.7                 | 2,405 | 0.02                | 11.0           | 700         |
| 14                      | 2    | B        | <b>PRM1402</b>                                 | 8                      | 3.2                   | 719   | 7.5                  | 1,686 | 0.02                | 12.6           | 445         |
| 14                      | 4    | B        | <b>PRM1404</b>                                 | 8                      | 5.7                   | 1,281 | 11.6                 | 2,608 | 0.02                | 11.8           | 445         |

## Miniature Rolled Ball Screws — PRM Series

### Type A — End Cap Design

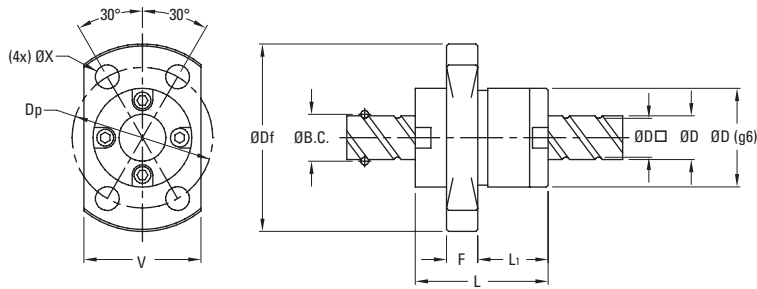

### Type B — Return Plate Design

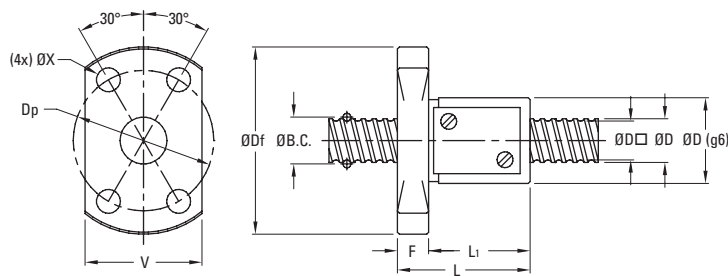

| Nominal Diameter (size) | Lead | Nut Type | Nut Specifications |                            |                  |                |                |                     |                         |                          |               |
|-------------------------|------|----------|--------------------|----------------------------|------------------|----------------|----------------|---------------------|-------------------------|--------------------------|---------------|
|                         |      |          | Outside Diameter D | Flange Outside Diameter Df | Overall Length L | Body Length L1 | Flange Width F | Flange Flat Width V | Bolt Circle Diameter Dp | Mounting Hole Diameter X | Ball Diameter |
| (mm)                    | (mm) |          | (mm)               | (mm)                       | (mm)             | (mm)           | (mm)           | (mm)                | (mm)                    | (mm)                     | (mm)          |
| 4                       | 1    | B        | 11.0               | 24.0                       | 17.0             | 13.0           | 4.0            | 15.0                | 18.0                    | 3.4                      | 0.80          |
| 5                       | 4    | B        | 12.0               | 24.0                       | 22.0             | 18.0           | 4.0            | 16.0                | 18.0                    | 3.4                      | 0.80          |
| 6                       | 1    | B        | 13.0               | 26.0                       | 17.0             | 13.0           | 4.0            | 16.0                | 20.0                    | 3.4                      | 0.80          |
| 6                       | 6    | A        | 14.0               | 27.0                       | 17.0             | 8.0            | 4.0            | 16.0                | 21.0                    | 3.4                      | 1.00          |
| 8                       | 1    | B        | 16.0               | 29.0                       | 17.0             | 13.0           | 4.0            | 18.0                | 23.0                    | 3.4                      | 0.80          |
| 8                       | 2    | B        | 20.0               | 37.0                       | 24.0             | 19.0           | 5.0            | 22.0                | 29.0                    | 4.5                      | 1.59          |
| 8                       | 5    | B        | 18.0               | 31.0                       | 28.0             | 24.0           | 4.0            | 20.0                | 25.0                    | 3.4                      | 1.59          |
| 8                       | 8    | A        | 18.0               | 31.0                       | 20.0             | 10.0           | 4.0            | 20.0                | 25.0                    | 3.4                      | 1.59          |
| 8                       | 12   | A        | 18.0               | 31.0                       | 27.0             | 17.0           | 4.0            | 20.0                | 25.0                    | 3.4                      | 1.59          |
| 10                      | 2    | B        | 23.0               | 40.0                       | 24.0             | 19.0           | 5.0            | 25.0                | 32.0                    | 4.5                      | 1.59          |
| 10                      | 10   | A        | 23.0               | 40.0                       | 24.0             | 13.0           | 5.0            | 25.0                | 32.0                    | 4.5                      | 2.00          |
| 10                      | 15   | A        | 23.0               | 40.0                       | 33.0             | 22.0           | 5.0            | 25.0                | 32.0                    | 4.5                      | 2.00          |
| 10                      | 20   | A        | 20.0               | 37.0                       | 23.0             | 13.0           | 5.0            | 22.0                | 29.0                    | 4.5                      | 1.59          |
| 12                      | 2    | B        | 25.0               | 42.0                       | 24.0             | 19.0           | 5.0            | 27.0                | 34.0                    | 4.5                      | 1.59          |
| 13                      | 12   | A        | 28.0               | 45.0                       | 30.0             | 17.0           | 5.0            | 30.0                | 37.0                    | 4.5                      | 2.38          |
| 13                      | 20   | A        | 28.0               | 45.0                       | 43.0             | 29.0           | 5.0            | 30.0                | 37.0                    | 4.5                      | 2.38          |
| 14                      | 2    | B        | 26.0               | 45.0                       | 25.0             | 19.0           | 6.0            | 28.0                | 36.0                    | 5.5                      | 1.59          |
| 14                      | 4    | B        | 30.0               | 49.0                       | 33.0             | 27.0           | 6.0            | 32.0                | 40.0                    | 5.5                      | 2.38          |

## Miniature Rolled Ball Screws — TSI Series

6mm to 14mm Diameter, Lead Accuracy:  $\pm 52\mu\text{m}/300\text{mm}$



### Internal Return Threaded Ball Nut and Screw

- Cost-effective solution in a small envelope, ideal for use in small spaces
- Flexible solution for non-standard mounting
- Available in two preload classes (Type Z2 or Z3)  
Z2 – no preload, clearance held to max indicated in table (standard unless specified)  
Z3 – no preload, clearance held to max .05mm

| Nominal Diameter | Lead | Ball Screw P/N | Ball Nut P/N | Performance Data                   |       |                                |       |                    |
|------------------|------|----------------|--------------|------------------------------------|-------|--------------------------------|-------|--------------------|
|                  |      |                |              | Dynamic Load Capacity ( $C_{am}$ ) |       | Static Load Capacity ( $C_0$ ) |       | Max Axial Backlash |
|                  |      |                |              | (kN)                               | (lbs) | (kN)                           | (lbs) |                    |
| 6                | 2    | 190-9684       | 8102-448-025 | 1.6                                | 360   | 2.1                            | 472   | 0.10               |
| 8                | 2    | 190-9685       | 8103-448-026 | 2.3                                | 517   | 2.9                            | 652   | 0.10               |
| 8                | 2.5  | 190-9686       | 8103-448-027 | 3.1                                | 697   | 4.0                            | 899   | 0.10               |
| 8                | 3    | 190-9687       | 8103-448-028 | 2.7                                | 607   | 3.1                            | 697   | 0.10               |
| 10               | 2    | 190-9680       | 8103-448-022 | 2.7                                | 607   | 3.8                            | 854   | 0.10               |
| 10               | 3    | 190-9681       | 8103-448-023 | 6.7                                | 1506  | 9.6                            | 2158  | 0.10               |
| 10               | 4    | 190-9688       | 8103-448-029 | 5.8                                | 1304  | 8.2                            | 1844  | 0.10               |
| 10               | 10   | 190-9689       | 8103-448-030 | 4.1                                | 922   | 5.8                            | 1304  | 0.10               |
| 12               | 2    | 190-9690       | 8105-448-031 | 4.5                                | 1012  | 7.6                            | 1709  | 0.10               |
| 12               | 3    | 190-9691       | 8105-448-032 | 9.6                                | 2158  | 16.4                           | 3687  | 0.10               |
| 14               | 3    | 190-9692       | 8105-448-033 | 6.7                                | 1506  | 11.6                           | 2608  | 0.10               |

## Miniature Rolled Ball Screws — TSI Series

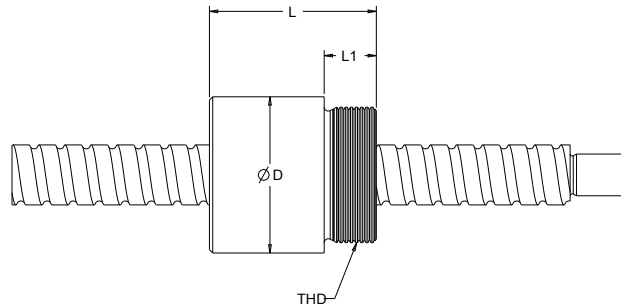

| Nominal Diameter | Lead | Screw Specifications |                |            |              | Nut Specifications |               |             |         |      |      |
|------------------|------|----------------------|----------------|------------|--------------|--------------------|---------------|-------------|---------|------|------|
|                  |      | Major Diameter       | Minor Diameter | Max Length | Screw Weight | No. of Circuits    | Ball Diameter | D (+0 / -1) | THD     | L    | L1   |
| (mm)             | (mm) | (mm)                 | (mm)           | (mm)       | (kg/m)       |                    | (mm)          | (mm)        |         | (mm) | (mm) |
| 6                | 2    | 5.9                  | 4.9            | 1000       | 0.22         | 8                  | 1.000         | 16          | M12x1   | 22   | 8    |
| 8                | 2    | 7.8                  | 6.3            | 1500       | 0.38         | 5                  | 1.588         | 18          | M15x1   | 24   | 8    |
| 8                | 2.5  | 7.8                  | 6.3            | 1500       | 0.38         | 7                  | 1.588         | 18          | M15x1   | 24   | 8    |
| 8                | 3    | 7.7                  | 5.9            | 1500       | 0.37         | 3                  | 1.984         | 18          | M16x1   | 25   | 8    |
| 10               | 2    | 9.8                  | 8.3            | 2000       | 0.59         | 5                  | 1.588         | 19.5        | M17x1   | 22   | 8    |
| 10               | 3    | 9.7                  | 8.0            | 2000       | 0.58         | 7                  | 1.984         | 21          | M18x1   | 29   | 9    |
| 10               | 4    | 9.7                  | 7.9            | 2000       | 0.58         | 6                  | 1.984         | 21          | M18x1   | 35   | 9    |
| 10               | 10   | 9.7                  | 7.9            | 2000       | 0.58         | 2x1.8              | 1.984         | 23          | M18x1   | 35   | 9    |
| 12               | 2    | 11.8                 | 10.3           | 2000       | 0.86         | 8                  | 1.588         | 24          | M20x1   | 40   | 10   |
| 12               | 3    | 11.7                 | 9.9            | 2000       | 0.85         | 9                  | 1.984         | 26          | M20x1   | 40   | 10   |
| 14               | 3    | 13.7                 | 12.0           | 2000       | 1.16         | 5                  | 1.984         | 30          | M24x1.5 | 35   | 9    |

**NOTES:**

A large grid area for taking notes, consisting of a 30x40 grid of small squares. The grid is empty and occupies the majority of the page below the 'NOTES:' header.

## Thomson Neff Rolled Ball Screws — Metric Series



**Thomson NEFF Rolled Ball Screw Assemblies** are designed and manufactured to provide high level performance at an affordable price. Ball screws are manufactured using Thomson's patented, German-engineered Precision Screw Forming (PST) Technology, which provides high accuracy (23 microns/300mm standard) with the manufacturing efficiency of rolled processes. Ball Screw Assemblies are available in a wide range of diameters, leads, and nut styles - all designed to provide quiet, smooth running, and efficient performance. Ball nuts include one of three unique ball return systems (depending on the diameter and lead of the screw used) providing perfect guidance, low wear, and smooth running performance. Thomson NEFF Rolled Ball Screw Assemblies are ideal for machining centers, factory automation, packaging, injection molding, wood working, water jet cutting, electronic assembly, and medical applications.

Need a quote or have a question about an application?  
Contact us in North America at:

Phone: 540-633-3549

Fax: 540-639-4162

Email: [thomson@thomsonlinear.com](mailto:thomson@thomsonlinear.com)

## Thomson NEFF Rolled Ball Screws — ZG Style Ball Nuts

Standard Lead Accuracy:  $\pm 23\mu\text{m}/300\text{mm}$



ZG Style Nut



**Quick Install**  
Available for Select Nuts

### Internal Return Threaded Ball Nut and Screw

- Flexible solution for non-standard mounting
- Integral wiper<sup>(4)</sup> included as standard
- Available in three preload classes (Type Z1, Z2, Z3)
  - Z1 – light preload to 1-2%
  - Z2 – no preload, clearance held to max indicated in table (standard unless specified)
  - Z3 – no preload, clearance held to max .05mm

| Nominal Diameter (size) | Lead | Ball Screw P/N <sup>(1)</sup><br><small>(2) (6)</small> | Ball Nut P/N     | Available Preload Types | Performance Data |                                    |       |                                |      | Screw Specifications <sup>(3)</sup> |                |                |                            |
|-------------------------|------|---|------------------|-------------------------|------------------|------------------------------------|-------|--------------------------------|------|-------------------------------------|----------------|----------------|----------------------------|
|                         |      |   |                  |                         | Type Z2 Standard | Dynamic Load Capacity ( $C_{am}$ ) |       | Static Load Capacity ( $C_o$ ) |      | Max. Axial Backlash                 | Major Diameter | Minor Diameter | Max. Length <sup>(5)</sup> |
|                         |      |   | (kN)             |                         |                  | (lbf)                              | (kN)  | (lbf)                          | (mm) |                                     |                |                |                            |
| 12                      | 4    | KGS-1204-023-RH   | KGM-G-1204-RH-00 | Z1, Z2, Z3              | 3.5              | 787                                | 4.0   | 899                            | 0.07 | 11.6                                | 9.7            | 3000           | 0.7                        |
| 16                      | 5    | KGS-1605-023-RH   | KGM-G-1605-RH-KK | Z1, Z2, Z3              | 12.1             | 2,720                              | 14.5  | 3,260                          | 0.09 | 15.6                                | 12.7           | 6000           | 1.2                        |
| 20                      | 5    | KGS-2005-023-RH   | KGM-G-2005-RH-KK | Z1, Z2, Z3              | 14.8             | 3,327                              | 20.7  | 4,654                          | 0.09 | 19.6                                | 16.7           | 6000           | 2.0                        |
| 25                      | 5    | KGS-2505-023-RH   | KGM-G-2505-RH-KK | Z1, Z2, Z3              | 20.4             | 4,586                              | 33.7  | 7,576                          | 0.09 | 24.6                                | 21.7           | 6000           | 3.3                        |
| 25                      | 10   | KGS-2510-023-RH   | KGM-G-2510-RH-KK | Z1, Z2, Z3              | 19.9             | 4,474                              | 31.8  | 7,149                          | 0.09 | 24.6                                | 21.7           | 6000           | 3.3                        |
| 32                      | 5    | KGS-3205-023-RH   | KGM-G-3205-RH-KK | Z1, Z2, Z3              | 23.3             | 5,238                              | 45.5  | 10,229                         | 0.09 | 31.6                                | 28.7           | 6000           | 5.6                        |
| 32                      | 10   | KGS-3210-023-RH-L                                       | KGM-G-3210-RH-KK | Z1, Z2, Z3              | 33.8             | 7,599                              | 52.0  | 11,690                         | 0.15 | 31.6                                | 27.1           | 6000           | 5.3                        |
| 40                      | 5    | KGS-4005-023-RH   | KGM-G-4005-RH-KK | Z1, Z2, Z3              | 26.3             | 5,912                              | 59.2  | 13,309                         | 0.09 | 39.6                                | 36.7           | 6000           | 9.0                        |
| 40                      | 10   | KGS-4010-023-RH   | KGM-G-4010-RH-KK | Z1, Z2, Z3              | 78.6             | 17,670                             | 136.2 | 30,619                         | 0.18 | 39.6                                | 34.0           | 6000           | 8.3                        |
| 40                      | 20   | KGS-4020-023-RH-L                                       | KGM-G-4020-RH-KK | Z1, Z2, Z3              | 34.2             | 7,689                              | 57.2  | 12,860                         | 0.18 | 40.0                                | 35.7           | 6000           | 8.9                        |
| 50                      | 10   | KGS-5010-023-RH   | KGM-G-5010-RH-KK | Z1, Z2, Z3              | 97.8             | 21,986                             | 213.2 | 47,929                         | 0.18 | 49.5                                | 43.0           | 6000           | 13.5                       |
| 63                      | 10   | KGS-6310-023-RH   | KGM-G-6310-RH-KK | Z1, Z2, Z3              | 109.7            | 24,662                             | 275.6 | 61,957                         | 0.18 | 62.5                                | 56.9           | 6000           | 22.0                       |
| 80                      | 10   | KGS-8010-050-RH   | KGM-G-8010-RH-KK | Z1, Z2, Z3              | 121.9            | 27,404                             | 375.0 | 84,303                         | 0.18 | 79.5                                | 73.9           | 6000           | 36.4                       |

(1) Thomson NEFF Ball Screws, Ball Nuts and End Blocks can be sold together as assemblies or separately as components (preloaded ball nuts sold only as an assembly).

(2) All ball screws and nuts are right-hand thread.

(3) Dimensional information on bearing supports and standard end machining is available on page 154.

(4) Wiper not included on 12 x 4 ball nut.

(5) Max. length includes 150mm on each end usable for end machining only. Max. travel length equals table value minus 300mm. Ends are hardened.

(6) -P5 Accuracy Class is  $\pm 23\mu\text{m}/300\text{mm}$ . -T7 Accuracy Class is  $\pm 52\mu\text{m}/300\text{mm}$

(7) -P3 Accuracy Class is  $\pm 12\mu\text{m}/300\text{mm}$ . and is available upon request for most sizes.



## Thomson NEFF Rolled Ball Screws — ZG Style Ball Nuts

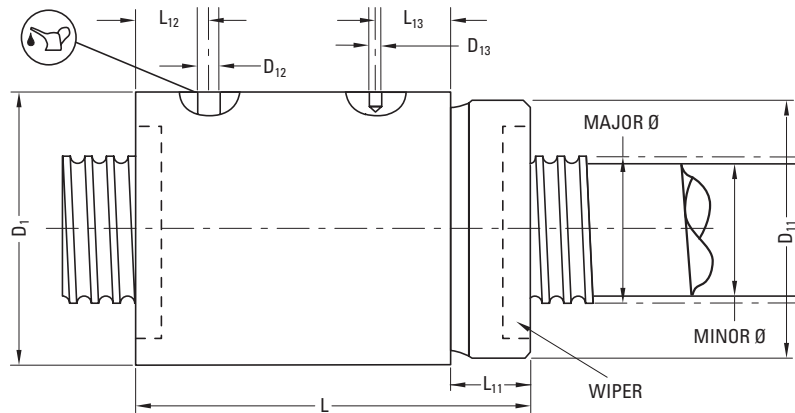

| Nominal Diameter (size) | Lead | Nut Specifications (mm) |                 |                 |                 |       |                 |                 |                 |            |               |
|-------------------------|------|-------------------------|-----------------|-----------------|-----------------|-------|-----------------|-----------------|-----------------|------------|---------------|
|                         |      | D <sub>1</sub>          | D <sub>11</sub> | D <sub>12</sub> | D <sub>13</sub> | L     | L <sub>11</sub> | L <sub>12</sub> | L <sub>13</sub> | Nut Weight | Ball Diameter |
| (mm)                    | (mm) | h12                     |                 |                 |                 | -0.2  |                 |                 |                 | (kg)       | (mm)          |
| 12                      | 4    | 25.0                    | M 20 x 1.0      | 3.0             | —               | 34.0  | 10.0            | 5.0             | —               | 0.10       | 1.984         |
| 16                      | 5    | 32.0                    | M 30 x 1.5      | M 6 x 1         | 4               | 57.5  | 16.5            | 10.5            | 22.0            | 0.22       | 3.500         |
| 20                      | 5    | 38.0                    | M 35 x 1.5      | M 6 x 1         | 4               | 57.5  | 16.5            | 10.5            | 22.0            | 0.30       | 3.500         |
| 25                      | 5    | 42.0                    | M 40 x 1.5      | M 6 x 1         | 4               | 63.5  | 17.0            | 10.5            | 23.0            | 0.37       | 3.500         |
| 25                      | 10   | 42.0                    | M 40 x 1.5      | M 6 x 1         | 4               | 61.0  | 17.0            | 10.0            | 21.0            | 0.38       | 3.500         |
| 32                      | 5    | 52.0                    | M 48 x 1.5      | M 6 x 1         | 5               | 65.5  | 19.0            | 10.5            | 23.0            | 0.55       | 3.500         |
| 32                      | 10   | 52.0                    | M 48 x 1.5      | M 6 x 1         | 5               | 85.0  | 19.0            | 12.0            | 43.0            | 0.65       | 5.556         |
| 40                      | 5    | 58.0                    | M 56 x 1.5      | M 8 x 1         | 5               | 67.5  | 19.0            | 12.0            | 22.5            | 0.60       | 3.500         |
| 40                      | 10   | 65.0                    | M 60 x 2.0      | M 8 x 1         | 6               | 105.5 | 27.0            | 13.0            | 43.0            | 1.25       | 7.144         |
| 40                      | 20   | 65.0                    | M 60 x 2.0      | M 6 x 1         | 6               | 83.0  | 27.0            | 10.0            | 33.0            | 0.80       | 5.556         |
| 50                      | 10   | 78.0                    | M 72 x 2.0      | M 8 x 1         | 6               | 118.0 | 29.0            | 13.0            | 53.0            | 1.95       | 7.144         |
| 63                      | 10   | 92.0                    | M 85 x 2.0      | M 8 x 1         | 6               | 118.0 | 29.0            | 13.0            | 53.0            | 2.40       | 7.144         |
| 80                      | 10   | 120.0                   | M 110 x 2.0     | M 8 x 1         | 8               | 126.0 | 34.0            | 15.5            | 53.0            | 4.90       | 7.144         |

## Thomson NEFF Rolled Ball Screws — FK/FH Style Ball Nuts

Standard Lead Accuracy:  $\pm 23\mu\text{m}/300\text{mm}^{(1)}$



**FK Style Nut**



**FH Style Nut**

### Internal Return Flanged Ball Nut and Screw

- Two nut styles (FK & FH) provide optimal performance in low and high lead assemblies
- Integral wiper and flange included as standard
- Available in three preload classes (Type Z1, Z2, Z3)  
Z1 – light preload to 1-2%  
Z2 – no preload, clearance held to max indicated in table (standard unless specified)  
Z3 – no preload, clearance held to max .05mm

| Nominal Diameter (size) | Lead | Nut Type | Ball Screw P/N <sup>(2) (3) (6)</sup> | Ball Nut P/N     | Available Preload Types | Performance Data                   |        |                                |        | Screw Specifications <sup>(4)</sup> |                |                |                            |              |
|-------------------------|------|----------|---------------------------------------|------------------|-------------------------|------------------------------------|--------|--------------------------------|--------|-------------------------------------|----------------|----------------|----------------------------|--------------|
|                         |      |          |                                       |                  |                         | Dynamic Load Capacity ( $C_{am}$ ) |        | Static Load Capacity ( $C_0$ ) |        | Max. Axial Backlash                 | Major Diameter | Minor Diameter | Max. Length <sup>(5)</sup> | Screw Weight |
|                         |      |          |                                       |                  |                         | (kN)                               | (lbf)  | (kN)                           | (lbf)  |                                     |                |                |                            |              |
| 16                      | 5    | FK       | KGS-1605-023-RH                       | KGF-D-1605-RH-KK | Z1, Z2, Z3              | 9.5                                | 2,136  | 10.9                           | 2,450  | 0.09                                | 15.6           | 12.7           | 6000                       | 1.2          |
| 20                      | 5    | FK       | KGS-2005-023-RH                       | KGF-D-2005-RH-KK | Z1, Z2, Z3              | 11.5                               | 2,585  | 15.5                           | 3,485  | 0.09                                | 19.6           | 16.7           | 6000                       | 2.0          |
| 20                      | 20   | FH       | KGS-2020-023-RH                       | KGF-D-2020-RH-KK | Z1, Z2, Z3              | 10.8                               | 2,428  | 17.5                           | 3,934  | 0.08                                | 19.6           | 16.7           | 6000                       | 1.9          |
| 25                      | 5    | FK       | KGS-2505-023-RH                       | KGF-D-2505-RH-KK | Z1, Z2, Z3              | 13.1                               | 2,945  | 20.2                           | 4,541  | 0.09                                | 24.6           | 21.7           | 6000                       | 3.3          |
| 25                      | 10   | FH       | KGS-2510-023-RH                       | KGF-D-2510-RH-KK | Z1, Z2, Z3              | 24.7                               | 5,553  | 53.4                           | 12,005 | 0.09                                | 24.6           | 21.7           | 6000                       | 3.3          |
| 25                      | 25   | FH       | KGS-2525-023-RH-L                     | KGF-D-2525-RH-KK | Z1, Z2, Z3              | 13.1                               | 2,945  | 22.6                           | 5,081  | 0.08                                | 24.6           | 22.0           | 6000                       | 3.3          |
| 32                      | 5    | FK       | KGS-3205-023-RH                       | KGF-D-3205-RH-KK | Z1, Z2, Z3              | 19.3                               | 4,339  | 36.3                           | 8,161  | 0.09                                | 31.6           | 28.7           | 6000                       | 5.6          |
| 32                      | 10   | FK       | KGS-3210-023-RH-L                     | KGF-D-3210-RH-KK | Z1, Z2, Z3              | 26.4                               | 5,935  | 39.0                           | 8,768  | 0.15                                | 31.6           | 27.1           | 6000                       | 5.3          |
| 32                      | 20   | FH       | KGS-3220-023-RH-L                     | KGF-D-3220-RH-KK | Z1, Z2, Z3              | 47.2                               | 10,611 | 83.2                           | 18,704 | 0.15                                | 31.6           | 27.1           | 6000                       | 5.3          |
| 32                      | 32   | FH       | KGS-3232-023-RH                       | KGF-D-3232-RH-KK | Z1, Z2, Z3              | 19.7                               | 4,429  | 39.0                           | 8,768  | 0.08                                | 31.3           | 28.3           | 6000                       | 5.3          |
| 40                      | 5    | FK       | KGS-4005-023-RH                       | KGF-D-4005-RH-KK | Z1, Z2, Z3              | 26.3                               | 5,912  | 59.2                           | 13,309 | 0.09                                | 39.6           | 36.7           | 6000                       | 9.0          |
| 40                      | 10   | FK       | KGS-4010-023-RH                       | KGF-D-4010-RH-KK | Z1, Z2, Z3              | 64.9                               | 14,590 | 109.0                          | 24,504 | 0.18                                | 39.6           | 34.0           | 6000                       | 8.3          |
| 40                      | 20   | FH       | KGS-4020-023-RH-L                     | KGF-D-4020-RH-KK | Z1, Z2, Z3              | 52.2                               | 11,735 | 103.6                          | 23,290 | 0.15                                | 39.6           | 35.2           | 6000                       | 7.6          |
| 40                      | 40   | FH       | KGS-4040-023-RH-L                     | KGF-D-4040-RH-KK | Z1, Z2, Z3              | 59.7                               | 13,421 | 108.9                          | 24,482 | 0.18                                | 39.6           | 34.0           | 6000                       | 8.4          |
| 50                      | 10   | FK       | KGS-5010-023-RH                       | KGF-D-5010-RH-KK | Z1, Z2, Z3              | 66.4                               | 14,927 | 134.3                          | 30,192 | 0.18                                | 49.5           | 43.0           | 6000                       | 13.5         |
| 50                      | 20   | FH       | KGS-5020-023-RH-L                     | KGF-D-5020-RH-KK | Z1, Z2, Z3              | 78.8                               | 17,715 | 188.7                          | 42,421 | 0.16                                | 49.5           | 44.6           | 6000                       | 13.6         |
| 63                      | 10   | FK       | KGS-6310-023-RH                       | KGF-D-6310-RH-KK | Z1, Z2, Z3              | 93.8                               | 21,087 | 229.7                          | 51,639 | 0.18                                | 62.5           | 56.9           | 6000                       | 22.0         |
| 63                      | 20   | FH       | KGS-6320-023-RH                       | KGF-D-6320-RH-KK | Z1, Z2, Z3              | 103.1                              | 23,178 | 270.8                          | 60,878 | 0.18                                | 62.5           | 56.9           | 6000                       | 22.0         |
| 80                      | 10   | FK       | KGS-8010-050-RH                       | KGF-D-8010-RH-KK | Z1, Z2, Z3              | 121.9                              | 27,404 | 374.9                          | 84,281 | 0.18                                | 79.5           | 73.9           | 6000                       | 36.4         |

(1) 80mm nominal diameter screws are  $\pm 52\mu\text{m}/300\text{mm}$ .

(2) Thomson NEFF Ball Screws, Ball Nuts and End Blocks can be sold together as assemblies or separately as components (preloaded ball nuts sold only as an assembly).

(3) All ball screws and nuts are right-hand thread.

(4) Dimensional information on bearing supports and standard end machining is available on page 154.

(5) Max. length includes 150mm on each end usable for end machining only. Max. travel length equals table value minus 300mm. Ends are hardened.

(6) -P5 Accuracy Class is  $\pm 23\mu\text{m}/300\text{mm}$ . -T7 Accuracy Class is  $\pm 52\mu\text{m}/300\text{mm}$

(7) -P3 Accuracy Class is  $\pm 12\mu\text{m}/300\text{mm}$ . and is available upon request for most sizes.

## Thomson NEFF Rolled Ball Screws — FK/FH Style Ball Nuts

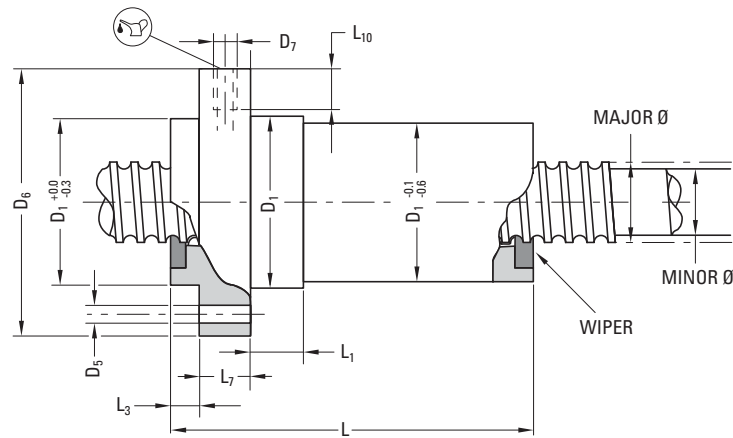

|                       | D <sub>7</sub> | L <sub>10</sub> |
|-----------------------|----------------|-----------------|
| d <sub>0</sub> < 40mm | M6 x 1         | 8               |
| d <sub>0</sub> ≥ 40mm | M8 x 1         | 10              |

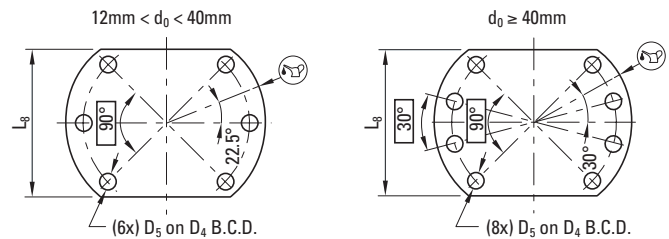

| Nominal Diameter (size) | Lead | Nut Specifications (mm) |                |                |                |       |                |                |                |                |            |               |
|-------------------------|------|-------------------------|----------------|----------------|----------------|-------|----------------|----------------|----------------|----------------|------------|---------------|
|                         |      | D <sub>1</sub>          | D <sub>4</sub> | D <sub>5</sub> | D <sub>6</sub> | L     | L <sub>1</sub> | L <sub>3</sub> | L <sub>7</sub> | L <sub>8</sub> | Nut Weight | Ball Diameter |
| (mm)                    | (mm) | g6                      |                | H13            | h13            |       |                |                | h13            | h13            | (kg)       | (mm)          |
| 16                      | 5    | 28.0                    | 38.0           | 5.5            | 48.0           | 48.5  | 10.0           | 5.5            | 10.0           | 40.0           | 0.3        | 3.500         |
| 20                      | 5    | 36.0                    | 47.0           | 6.6            | 58.0           | 48.5  | 10.0           | 5.5            | 10.0           | 44.0           | 0.4        | 3.500         |
| 20                      | 20   | 36.0                    | 47.0           | 6.6            | 58.0           | 36.0  | 4.0            | 11.0           | 10.0           | 44.0           | 0.5        | 3.500         |
| 25                      | 5    | 40.0                    | 51.0           | 6.6            | 62.0           | 49.0  | 10.0           | 6.0            | 10.0           | 48.0           | 0.4        | 3.500         |
| 25                      | 10   | 40.0                    | 51.0           | 6.6            | 62.0           | 51.0  | 21.0           | 10.0           | 10.0           | 48.0           | 0.5        | 3.500         |
| 25                      | 25   | 40.0                    | 51.0           | 6.6            | 62.0           | 39.0  | 9.0            | 10.0           | 10.0           | 48.0           | 0.6        | 3.500         |
| 32                      | 5    | 50.0                    | 65.0           | 9.0            | 80.0           | 57.0  | 10.0           | 6.0            | 12.0           | 62.0           | 0.7        | 3.500         |
| 32                      | 10   | 50.0                    | 65.0           | 9.0            | 80.0           | 73.0  | 16.0           | 6.0            | 12.0           | 62.0           | 0.8        | 5.556         |
| 32                      | 20   | 56.0                    | 71.0           | 9.0            | 86.0           | 83.0  | 25.0           | 19.0           | 12.0           | 68.0           | 1.4        | 5.556         |
| 32                      | 32   | 56.0                    | 71.0           | 9.0            | 86.0           | 42.0  | 12.0           | 9.0            | 12.0           | 68.0           | 0.8        | 3.969         |
| 40                      | 5    | 63.0                    | 78.0           | 9.0            | 93.0           | 66.0  | 10.0           | 7.0            | 14.0           | 70.0           | 1.2        | 3.500         |
| 40                      | 10   | 63.0                    | 78.0           | 9.0            | 93.0           | 88.5  | 16.0           | 7.0            | 14.0           | 70.0           | 1.4        | 7.144         |
| 40                      | 20   | 63.0                    | 78.0           | 9.0            | 93.0           | 83.0  | 25.0           | 19.5           | 14.0           | 70.0           | 1.6        | 5.556         |
| 40                      | 40   | 70.0                    | 85.0           | 9.0            | 100.0          | 104.0 | 25.0           | 21.0           | 14.0           | 77.0           | 2.4        | 7.144         |
| 50                      | 10   | 75.0                    | 93.0           | 11.0           | 110.0          | 92.0  | 16.0           | 7.0            | 16.0           | 85.0           | 2.0        | 7.144         |
| 50                      | 20   | 75.0                    | 93.0           | 11.0           | 110.0          | 85.0  | 16.0           | 22.0           | 16.0           | 85.0           | 2.2        | 6.400         |
| 63                      | 10   | 90.0                    | 108.0          | 11.0           | 125.0          | 103.5 | 16.0           | 7.0            | 18.0           | 95.0           | 3.0        | 7.144         |
| 63                      | 20   | 95.0                    | 115.0          | 13.5           | 135.0          | 86.0  | 18.0           | 24.0           | 20.0           | 100.0          | 3.8        | 7.144         |
| 80                      | 10   | 105.0                   | 125.0          | 13.5           | 145.0          | 121.0 | 16.0           | 9.0            | 20.0           | 110.0          | 3.9        | 7.144         |

## FSI Style Ball Nuts

Standard Lead Accuracy:  $\pm 23 \mu\text{m} / 300 \text{mm}^{(1)}$



**If Z1 Preload is Required,  
Order KGF-D Style Nut**

### Internal Return Flanged Ball Nut and Screw

- Flexible solution for standard mounting
- Integral wiper and flange included as standard
- Available in two preload classes (Type Z2, Z3)
  - Z2 – no preload, clearance held to nominal indicated in table (standard unless specified)
  - Z3 – no preload, clearance held to max 0.05 mm

| Nominal Diameter (size) | Lead | Nut Type | Ball Screw P/N | Ball Nut P/N | Performance Data                   |       |                                |       |                     | Screw Specifications |                |                            |              |
|-------------------------|------|----------|----------------|--------------|------------------------------------|-------|--------------------------------|-------|---------------------|----------------------|----------------|----------------------------|--------------|
|                         |      |          |                |              | Dynamic Load Capacity ( $C_{am}$ ) |       | Static Load Capacity ( $C_o$ ) |       | Max. Axial Backlash | Major Diameter       | Minor Diameter | Max. Length <sup>(2)</sup> | Screw Weight |
|                         |      |          |                |              | (kN)                               | (lbs) | (kN)                           | (lbs) |                     |                      |                |                            |              |
| 16                      | 5    | E        | 195-9698       | 7106-448-061 | 9.3                                | 2091  | 13.1                           | 2945  | 0.08                | 15.3                 | 12.9           | 6000                       | 1.30         |
| 16                      | 10   | E        | 195-9699       | 7106-448-062 | 15.4                               | 3462  | 26.5                           | 5958  | 0.08                | 15.2                 | 13.0           | 6000                       | 1.30         |
| 20                      | 5    | E        | 195-9700       | 7107-448-063 | 10.5                               | 2361  | 16.6                           | 3732  | 0.08                | 19.3                 | 16.9           | 6000                       | 2.00         |
| 25                      | 5    | E        | 195-9701       | 7110-448-064 | 12.3                               | 2765  | 22.5                           | 5058  | 0.08                | 24.3                 | 21.9           | 6000                       | 3.30         |
| 25                      | 10   | E        | 195-9702       | 7110-448-065 | 13.2                               | 2968  | 25.3                           | 5688  | 0.08                | 24.3                 | 21.9           | 6000                       | 3.30         |
| 25                      | 20   | S        | 195-9703       | 7110-448-066 | 13.0                               | 2923  | 23.3                           | 5238  | 0.15                | 24.4                 | 22.0           | 6000                       | 3.30         |
| 25                      | 25   | S        | 195-9704       | 7110-448-067 | 16.7                               | 3754  | 32.2                           | 7239  | 0.08                | 24.3                 | 22.0           | 6000                       | 3.30         |
| 32                      | 5    | E        | 195-9706       | 7112-448-069 | 21.5                               | 4834  | 49.3                           | 11084 | 0.08                | 31.3                 | 28.9           | 6000                       | 5.60         |
| 32                      | 10   | E        | 195-9707       | 7112-448-070 | 33.4                               | 7509  | 54.5                           | 12253 | 0.08                | 32.5                 | 27.3           | 6000                       | 5.60         |
| 32                      | 20   | E        | 195-9708       | 7112-448-071 | 29.7                               | 6677  | 59.8                           | 13444 | 0.08                | 31.5                 | 27.9           | 6000                       | 5.60         |
| 40                      | 5    | E        | 195-9710       | 7115-448-073 | 23.8                               | 5351  | 63.1                           | 14186 | 0.08                | 39.3                 | 36.9           | 6000                       | 9.00         |
| 40                      | 10   | E        | 195-9711       | 7115-448-074 | 38.0                               | 8543  | 69.1                           | 15535 | 0.08                | 39.3                 | 34.1           | 6000                       | 8.40         |
| 40                      | 20   | E        | 195-9712       | 7115-448-075 | 33.3                               | 7487  | 76.1                           | 17109 | 0.08                | 39.5                 | 35.9           | 6000                       | 9.00         |
| 40                      | 40   | S        | 195-9713       | 7115-448-076 | 35.0                               | 7869  | 101.9                          | 22909 | 0.08                | 38.7                 | 36.3           | 6000                       | 9.00         |
| 50                      | 10   | E        | 195-9714       | 7120-448-077 | 68.7                               | 15445 | 155.8                          | 35027 | 0.08                | 49.3                 | 44.1           | 6000                       | 13.50        |

(1) P3 accuracy class is  $\pm 12 \mu\text{m} / 300 \text{mm}$  and is available upon request.

(2) Dimension does not comply with DIN 69051.

(3) Round flange.

### FSI Style Ball Nuts

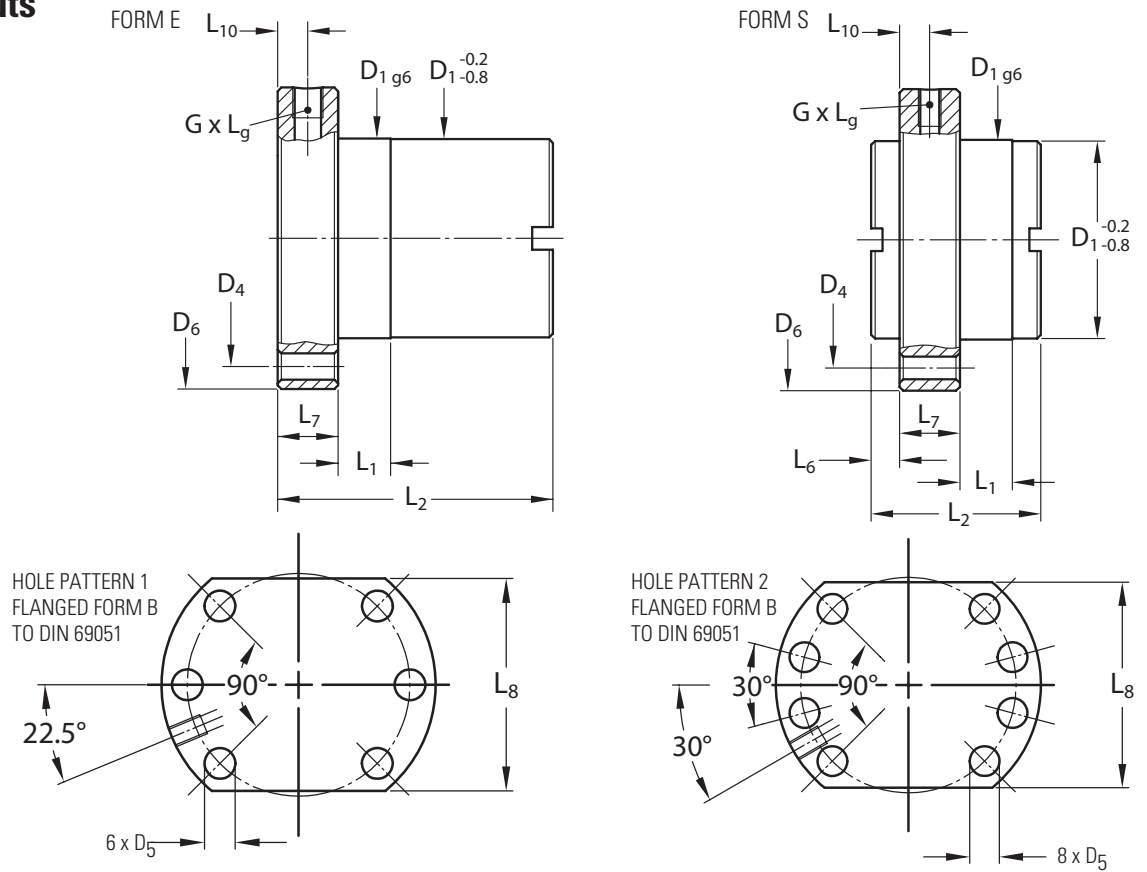

| Nominal Diameter (size) | Lead | Hole Pattern | Nut Specifications (mm) |       |       |       |       |       |       |       |                    |       |          |               |                 |               |
|-------------------------|------|--------------|-------------------------|-------|-------|-------|-------|-------|-------|-------|--------------------|-------|----------|---------------|-----------------|---------------|
|                         |      |              | $D_1$                   | $D_4$ | $D_5$ | $D_6$ | $L_1$ | $L_2$ | $L_6$ | $L_7$ | $L_8$              | $L_9$ | $L_{10}$ | Lube Hole (G) | No. of Circuits | Ball Diameter |
| (mm)                    | (mm) |              | g6                      |       |       |       |       |       |       |       |                    |       |          |               |                 | (mm)          |
| 16                      | 5    | 1            | 28.0                    | 38.0  | 6.0   | 48.0  | 10.0  | 42.0  | -     | 10.0  | 40.0               | 5.0   | M6x1     | 3             | 3.500           | 2.000         |
| 16                      | 10   | 1            | 28.0                    | 38.0  | 6.0   | 48.0  | 10.0  | 55.0  | -     | 10.0  | 40.0               | 5.0   | M6x1     | 6             | 3.000           | 3.500         |
| 20                      | 5    | 1            | 36.0                    | 47.0  | 7.0   | 58.0  | 10.0  | 42.0  | -     | 10.0  | 44.0               | 5.0   | M6x1     | 3             | 3.500           | 3.000         |
| 25                      | 5    | 1            | 40.0                    | 51.0  | 7.0   | 62.0  | 10.0  | 42.0  | -     | 10.0  | 48.0               | 5.0   | M6x1     | 3             | 3.500           | 3.500         |
| 25                      | 10   | 1            | 40.0                    | 51.0  | 7.0   | 62.0  | 16.0  | 55.0  | -     | 10.0  | 48.0               | 5.0   | M6x1     | 3             | 3.500           | 3.500         |
| 25                      | 20   | 1            | 40.0                    | 51.0  | 7.0   | 62.0  | 4.0   | 35.0  | 10.5  | 10.0  | 48.0               | 5.0   | M6x1     | 4             | 3.500           | 3.500         |
| 25                      | 25   | 1            | 40.0                    | 51.0  | 7.0   | 62.0  | 9.0   | 35.0  | 8.0   | 10.0  | N/A <sup>[3]</sup> | 5.0   | M6x1     | 5             | 3.500           | 3.500         |
| 32                      | 5    | 1            | 50.0                    | 65.0  | 9.0   | 80.0  | 10.0  | 55.0  | -     | 12.0  | 62.0               | 6.0   | M6x1     | 5             | 3.500           | 3.500         |
| 32                      | 10   | 1            | 53.0 <sup>[2]</sup>     | 65.0  | 9.0   | 80.0  | 16.0  | 69.0  | -     | 12.0  | 62.0               | 6.0   | M8x1     | 3             | 7.140           | 3.500         |
| 32                      | 20   | 1            | 53.0 <sup>[2]</sup>     | 65.0  | 9.0   | 80.0  | 16.0  | 80.0  | -     | 12.0  | 62.0               | 6.0   | M6x1     | 4             | 5.000           | 3.500         |
| 40                      | 5    | 2            | 63.0                    | 78.0  | 9.0   | 93.0  | 10.0  | 57.0  | -     | 14.0  | 70.0               | 7.0   | M6x1     | 5             | 3.500           | 3.500         |
| 40                      | 10   | 2            | 63.0                    | 78.0  | 9.0   | 93.0  | 16.0  | 71.0  | -     | 14.0  | 70.0               | 7.0   | M8x1     | 3             | 7.140           | 7.140         |
| 40                      | 20   | 2            | 63.0                    | 78.0  | 9.0   | 93.0  | 16.0  | 80.0  | -     | 14.0  | 70.0               | 7.0   | M8x1     | 4             | 5.000           | 7.140         |
| 40                      | 40   | 2            | 63.0                    | 78.0  | 9.0   | 93.0  | 16.0  | 85.0  | 7.5   | 14.0  | N/A <sup>[3]</sup> | 7.0   | M8x1     | 8             | 3.500           | 7.140         |
| 50                      | 10   | 2            | 75.0                    | 93.0  | 11.0  | 110.0 | 16.0  | 95.0  | -     | 16.0  | 85.0               | 8.0   | M8x1     | 5             | 7.140           | 7.140         |

## Thomson NEFF Rolled Ball Screws — KGF-D Style Ball Nuts

Standard Lead Accuracy:  $\pm 23\mu\text{m}/300\text{mm}^{(1)}$



**KGF-D Style Nut**

### Internal Return Flanged Ball Nut and Screw

- Flexible solution for standard mounting
- Integral wiper and flange included as standard
- Available in three preload classes (Type Z1, Z2, Z3)
  - Z1 – light preload to 1 – 2%
  - Z2 – no preload, clearance held to max indicated in table (standard unless specified)
  - Z3 – no preload, clearance held to max .05mm

**p145** Quick Install  
Available for Select Nuts

**p124-125** Z2 & Z3 Preload Class  
For Shorter Lead Times and Reduced Shipping Costs,  
Order FSI Style Ball Nuts

| Nominal Diameter (size) | Lead | Nut Type | Ball Screw P/N <sup>(1) (2) (3)</sup> | Ball Nut P/N     | Available Preload Types <sup>(4)</sup> | Performance Data                   |        |                                |        | Screw Specifications <sup>(6)</sup> |                |                |                            |              |
|-------------------------|------|----------|---------------------------------------|------------------|--|------------------------------------|--------|--------------------------------|--------|-------------------------------------|----------------|----------------|----------------------------|--------------|
|                         |      |          |                                       |                  |  | Dynamic Load Capacity ( $C_{am}$ ) |        | Static Load Capacity ( $C_o$ ) |        | Max. Axial Backlash                 | Major Diameter | Minor Diameter | Max. Length <sup>(7)</sup> | Screw Weight |
|                         |      |          |                                       |                  |  | (kN)                               | (lbf)  | (kN)                           | (lbf)  |                                     |                |                |                            |              |
| 12                      | 10   | S        | KGS-1210-023-RH                       | KGF-D-1210-RH-00 | Z1, Z2, Z3                             | 4.9                                | 1,102  | 8.0                            | 1,800  | 0.08                                | 11.5           | 10.1           | 3000                       | 0.8          |
| 16                      | 5    | E        | KGS-1605-023-RH                       | KGF-D-1605-RH-EE | Z1, Z2, Z3                             | 9.3                                | 2,091  | 13.1                           | 2,945  | 0.08                                | 15.3           | 12.9           | 6000                       | 1.3          |
| 16                      | 10   | E        | KGS-1610-023-RH                       | KGF-D-1610-RH-EE | Z1, Z2, Z3                             | 15.4                               | 3,462  | 26.5                           | 5,957  | 0.08                                | 15.2           | 13.0           | 6000                       | 1.3          |
| 20                      | 5    | E        | KGS-2005-023-RH                       | KGF-D-2005-RH-EE | Z1, Z2, Z3                             | 10.5                               | 2,361  | 16.6                           | 3,732  | 0.08                                | 19.3           | 16.9           | 6000                       | 2.0          |
| 25                      | 5    | E        | KGS-2505-023-RH                       | KGF-D-2505-RH-EE | Z1, Z2, Z3                             | 12.3                               | 2,766  | 22.5                           | 5,058  | 0.08                                | 24.3           | 21.9           | 6000                       | 3.3          |
| 25                      | 10   | E        | KGS-2510-023-RH                       | KGF-D-2510-RH-EE | Z1, Z2, Z3                             | 13.2                               | 2,968  | 25.3                           | 5,688  | 0.08                                | 24.3           | 21.9           | 6000                       | 3.3          |
| 25                      | 20   | S        | KGS-2520-023-RH                       | KGF-D-2520-RH-EE | Z1, Z2, Z3                             | 13.0                               | 2,921  | 23.3                           | 5,238  | 0.15                                | 24.4           | 22.0           | 6000                       | 3.3          |
| 25                      | 25   | S        | KGS-2525-023-RH                       | KGF-D-2525-RH-EE | Z1, Z2, Z3                             | 16.7                               | 3,755  | 32.2                           | 7,239  | 0.08                                | 24.3           | 22.0           | 6000                       | 3.3          |
| 25                      | 50   | S        | KGS-2550-023-RH                       | KGF-D-2550-RH-EE | Z1, Z2, Z3                             | 15.4                               | 3,463  | 31.7                           | 7,126  | 0.15                                | 23.9           | 21.5           | 6000                       | 3.3          |
| 32                      | 5    | E        | KGS-3205-023-RH                       | KGF-D-3205-RH-EE | Z1, Z2, Z3                             | 21.5                               | 4,834  | 49.3                           | 11,083 | 0.08                                | 31.3           | 28.9           | 6000                       | 5.6          |
| 32                      | 10   | E        | KGS-3210-023-RH                       | KGF-D-3210-RH-EE | Z1, Z2, Z3                             | 33.4                               | 7,509  | 54.5                           | 12,252 | 0.08                                | 32.5           | 27.3           | 6000                       | 5.6          |
| 32                      | 20   | E        | KGS-3220-023-RH                       | KGF-D-3220-RH-EE | Z1, Z2, Z3                             | 29.7                               | 6,678  | 59.8                           | 13,444 | 0.08                                | 31.5           | 27.9           | 6000                       | 5.6          |
| 32                      | 32   | S        | KGS-3232-023-RH                       | KGF-D-3232-RH-EE | Z1, Z2, Z3                             | 18.0                               | 4,047  | 34.7                           | 7,800  | 0.15                                | 31.6           | 27.1           | 6000                       | 5.3          |
| 40                      | 5    | E        | KGS-4005-023-RH                       | KGF-D-4005-RH-EE | Z1, Z2, Z3                             | 23.8                               | 5,351  | 63.1                           | 14,185 | 0.08                                | 39.3           | 36.9           | 6000                       | 9.0          |
| 40                      | 10   | E        | KGS-4010-023-RH                       | KGF-D-4010-RH-EE | Z1, Z2, Z3                             | 38.0                               | 8,544  | 69.1                           | 15,534 | 0.08                                | 39.3           | 34.1           | 6000                       | 8.4          |
| 40                      | 20   | E        | KGS-4020-023-RH                       | KGF-D-4020-RH-EE | Z1, Z2, Z3                             | 33.3                               | 7,487  | 76.1                           | 17,108 | 0.08                                | 39.5           | 35.9           | 6000                       | 9.0          |
| 40                      | 40   | S        | KGS-4040-023-RH                       | KGF-D-4040-RH-EE | Z1, Z2, Z3                             | 35.0                               | 7,869  | 101.9                          | 22,908 | 0.08                                | 38.7           | 36.3           | 6000                       | 9.0          |
| 50                      | 10   | E        | KGS-5010-023-RH                       | KGF-D-5010-RH-EE | Z1, Z2, Z3                             | 68.7                               | 15,446 | 155.8                          | 35,025 | 0.08                                | 49.3           | 44.1           | 6000                       | 13.5         |
| 50                      | 20   | E        | KGS-5020-023-RH                       | KGF-D-5020-RH-EE | Z1, Z2, Z3                             | 60.0                               | 13,490 | 136.3                          | 30,641 | 0.08                                | 49.3           | 44.1           | 6000                       | 13.5         |
| 63                      | 10   | E        | KGS-6310-023-RH                       | KGF-D-6310-RH-EE | Z1, Z2, Z3                             | 76.0                               | 17,086 | 197.0                          | 44,290 | 0.08                                | 62.6           | 57.2           | 6000                       | 22.0         |
| 63                      | 20   | E        | KGS-6320-023-RH                       | KGF-D-6320-RH-EE | Z1, Z2, Z3                             | 65.1                               | 14,635 | 169.5                          | 38,105 | 0.08                                | 62.6           | 57.2           | 6000                       | 22.0         |

(1) -P3 Accuracy Class is  $\pm 12\mu\text{m}/300\text{mm}$ . and is available upon request for most sizes.

(2) Thomson NEFF Rolled Ball Screws, Ball Nuts and End Blocks can be sold together as assemblies or separately as components (preloaded ball nuts sold only as an assembly).

(3) All ball screws and nuts are right-hand thread.

(4) Double nut pre-load systems (for up to 10% of dynamic load rating) are also available for all sizes. Contact customer service for more details.

(5) Round flange.

(6) Dimensional information on bearing supports and standard end machining is available on page 154.

(7) Max. length includes 200mm on each end usable for end machining only. Max. travel length equals table value minus 400mm. Ends are soft annealed.

# Thomson NEFF Rolled Ball Screws — KGF-D Style Ball Nuts

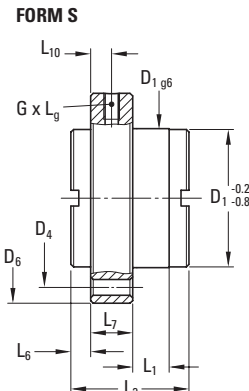
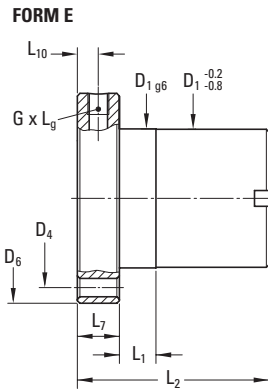

**MATERIAL:** 1.7131 (ESP65) / 1.3505 (100 Cr 6)

HOLE PATTERN 0 12mm Only

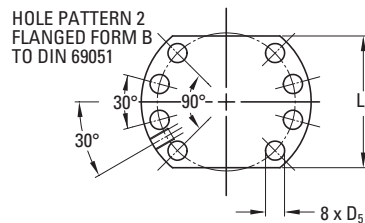
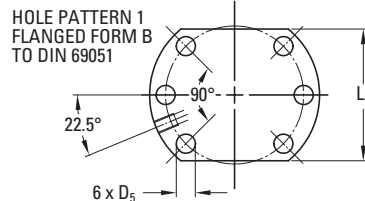
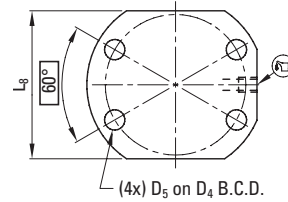

| Nominal Diameter (size) | Lead | Hole Pattern | Nut Specifications (mm) |                |                |                |                |                |                |                |                    |                |                 |               |                 |                 |                    |
|-------------------------|------|--------------|-------------------------|----------------|----------------|----------------|----------------|----------------|----------------|----------------|--------------------|----------------|-----------------|---------------|-----------------|-----------------|--------------------|
|                         |      |              | D <sub>1</sub>          | D <sub>4</sub> | D <sub>5</sub> | D <sub>6</sub> | L <sub>1</sub> | L <sub>2</sub> | L <sub>6</sub> | L <sub>7</sub> | L <sub>8</sub>     | L <sub>9</sub> | L <sub>10</sub> | Lube Hole (G) | No. of Circuits | Nut Weight (kg) | Ball Diameter (mm) |
| (mm)                    | (mm) |              | g6                      |                |                |                |                |                |                |                |                    |                |                 |               |                 |                 |                    |
| 12                      | 10   | 0            | 24.0                    | 32.0           | 4.5            | 40.0           | 9.5            | 27.5           | 5.0            | 8.0            | 26.0               | 6.0            | 4.0             | M 5x.8        | 4               | 0.10            | 2.000              |
| 16                      | 5    | 1            | 28.0                    | 38.0           | 5.5            | 48.0           | 10.0           | 42.0           | —              | 10.0           | 40.0               | 10.0           | 5.0             | M 6           | 3               | 0.20            | 3.500              |
| 16                      | 10   | 1            | 28.0                    | 38.0           | 5.5            | 48.0           | 10.0           | 55.0           | —              | 10.0           | 40.0               | 10.0           | 5.0             | M 6           | 6               | 0.30            | 3.000              |
| 20                      | 5    | 1            | 36.0                    | 47.0           | 6.6            | 58.0           | 10.0           | 42.0           | —              | 10.0           | 44.0               | 10.0           | 5.0             | M 6           | 3               | 0.25            | 3.500              |
| 25                      | 5    | 1            | 40.0                    | 51.0           | 6.6            | 62.0           | 10.0           | 42.0           | —              | 10.0           | 48.0               | 10.0           | 5.0             | M 6           | 3               | 0.35            | 3.500              |
| 25                      | 10   | 1            | 40.0                    | 51.0           | 6.6            | 62.0           | 16.0           | 55.0           | —              | 10.0           | 48.0               | 10.0           | 5.0             | M 6           | 3               | 0.45            | 3.500              |
| 25                      | 20   | 1            | 40.0                    | 51.0           | 6.6            | 62.0           | 4.0            | 35.0           | 10.5           | 10.0           | 48.0               | 8.0            | 5.0             | M 6           | 4               | 0.30            | 3.500              |
| 25                      | 25   | 1            | 40.0                    | 51.0           | 6.6            | 62.0           | 9.0            | 35.0           | 8.0            | 10.0           | N/A <sup>(5)</sup> | 8.0            | 5.0             | M 6           | 5               | 0.65            | 3.500              |
| 25                      | 50   | 1            | 40.0                    | 51.0           | 6.6            | 62.0           | 10.0           | 58.0           | 10.0           | 10.0           | 48.0               | 8.0            | 5.0             | M 6           | 5               | 0.40            | 3.500              |
| 32                      | 5    | 1            | 50.0                    | 65.0           | 9.0            | 80.0           | 10.0           | 55.0           | —              | 12.0           | 62.0               | 10.0           | 6.0             | M 6           | 5               | 0.55            | 3.500              |
| 32                      | 10   | 1            | 53.0                    | 65.0           | 9.0            | 80.0           | 16.0           | 69.0           | —              | 12.0           | 62.0               | 10.0           | 6.0             | M 8x1         | 3               | 0.90            | 7.140              |
| 32                      | 20   | 1            | 53.0                    | 65.0           | 9.0            | 80.0           | 16.0           | 80.0           | —              | 12.0           | 62.0               | 10.0           | 6.0             | M 6           | 4               | 1.10            | 5.000              |
| 32                      | 32   | 1            | 50.0                    | 65.0           | 9.0            | 80.0           | 12.0           | 42.0           | 9.0            | 12.0           | 62.0               | 8.0            | 6.0             | M 6           | 4               | 0.80            | 3.969              |
| 40                      | 5    | 2            | 63.0                    | 78.0           | 9.0            | 93.0           | 10.0           | 57.0           | —              | 14.0           | 70.0               | 10.0           | 7.0             | M 6           | 5               | 0.70            | 3.500              |
| 40                      | 10   | 2            | 63.0                    | 78.0           | 9.0            | 93.0           | 16.0           | 71.0           | —              | 14.0           | 70.0               | 10.0           | 7.0             | M 8x1         | 3               | 1.20            | 7.140              |
| 40                      | 20   | 2            | 63.0                    | 78.0           | 9.0            | 93.0           | 16.0           | 80.0           | —              | 14.0           | 70.0               | 10.0           | 7.0             | M 8x1         | 4               | 1.50            | 5.000              |
| 40                      | 40   | 2            | 63.0                    | 78.0           | 9.0            | 93.0           | 16.0           | 85.0           | 7.5            | 14.0           | N/A <sup>(5)</sup> | 10.0           | 7.0             | M 8x1         | 8               | 1.20            | 3.500              |
| 50                      | 10   | 2            | 75.0                    | 93.0           | 11.0           | 110.0          | 16.0           | 95.0           | —              | 16.0           | 85.0               | 10.0           | 8.0             | M 8x1         | 5               | 2.00            | 7.140              |
| 50                      | 20   | 2            | 85.0                    | 103.0          | 11.0           | 125.0          | 22.0           | 95.0           | —              | 18.0           | 95.0               | 10.0           | 9.0             | M 8x1         | 4               | 2.50            | 7.140              |
| 63                      | 10   | 2            | 90.0                    | 108.0          | 11.0           | 125.0          | 16.0           | 97.0           | —              | 18.0           | 95.0               | 10.0           | 9.0             | M 8x1         | 5               | 2.95            | 7.140              |
| 63                      | 20   | 2            | 95.0                    | 115.0          | 14.0           | 135.0          | 25.0           | 99.0           | —              | 20.0           | 100.0              | 10.0           | 10.0            | M 8x1         | 4               | 2.95            | 7.140              |

## Thomson NEFF Rolled Ball Screws — KGF-N Style Ball Nuts

Standard Lead Accuracy:  $\pm 23\mu\text{m}/300\text{mm}^{(1)}$



**KGF-N Style Nut**



**Quick Install**  
Available for 32x40 Only

### Internal Return Flanged Ball Nut and Screw

- Flexible solution for non-standard mounting
- Integral wiper and flange included as standard
- Available in three preload classes (Type Z1, Z2, Z3)
  - Z1 – light preload to 1 – 2%
  - Z2 – no preload, clearance held to max indicated in table (standard unless specified)
  - Z3 – no preload, clearance held to max .05mm

| Nominal Diameter (size) | Lead | Nut Type | Ball Screw P/N <sup>(1) (2) (3)</sup> | Ball Nut P/N     | Available Preload Types <sup>(4)</sup> | Performance Data |        |                                    |        | Screw Specifications <sup>(5)</sup> |      |                     |                     |                |                            |
|-------------------------|------|----------|---------------------------------------|------------------|--|------------------|--------|------------------------------------|--------|-------------------------------------|------|---------------------|---------------------|----------------|----------------------------|
|                         |      |          |                                       |                  |  | Z2 Standard      |        | Dynamic Load Capacity ( $C_{am}$ ) |        | Static Load Capacity ( $C_o$ )      |      | Max. Axial Backlash | Major Diameter      | Minor Diameter | Max. Length <sup>(6)</sup> |
|                         |      |          |                                       | (mm)             |  | (mm)             | (kN)   | (lbf)                              | (kN)   | (lbf)                               | (mm) | (mm)                | (mm)                | (mm)           | (kg/m)                     |
| 16                      | 5    | E        | KGS-1605-023-RH                       | KGF-N-1605-RH-EE | Z1, Z2, Z3                             | 9.3              | 2,091  | 13.1                               | 2,945  | 0.08                                | 15.3 | 12.9                | 6000                | 1.3            |                            |
| 20                      | 5    | E        | KGS-2005-023-RH                       | KGF-N-2005-RH-EE | Z1, Z2, Z3                             | 10.5             | 2,361  | 16.6                               | 3,732  | 0.08                                | 19.3 | 16.9                | 6000                | 2.0            |                            |
| 20                      | 20   | S        | KGS-2020-023-RH                       | KGF-N-2020-RH-EE | Z1, Z2, Z3                             | 11.6             | 2,608  | 18.4                               | 4,136  | 0.08                                | 19.3 | 16.9                | 6000                | 2.0            |                            |
| 20                      | 50   | S        | KGS-2050-023-RH                       | KGF-N-2050-RH-EE | Z1, Z2, Z3                             | 13.0             | 2,923  | 24.6                               | 5,530  | 0.15                                | 18.9 | 16.5                | 6000                | 2.0            |                            |
| 25                      | 5    | E        | KGS-2505-023-RH                       | KGF-N-2505-RH-EE | Z1, Z2, Z3                             | 12.3             | 2,766  | 22.5                               | 5,058  | 0.08                                | 24.3 | 21.9                | 6000                | 3.3            |                            |
| 32                      | 5    | E        | KGS-3205-023-RH                       | KGF-N-3205-RH-EE | Z1, Z2, Z3                             | 21.5             | 4,834  | 49.3                               | 11,083 | 0.08                                | 31.3 | 28.9                | 6000                | 5.6            |                            |
| 32                      | 10   | E        | KGS-3210-023-RH                       | KGF-N-3210-RH-EE | Z1, Z2, Z3                             | 33.4             | 7,509  | 54.5                               | 12,252 | 0.08                                | 32.5 | 27.3                | 6000                | 5.6            |                            |
| 32                      | 40   | S        | KGS-3240-023-RH                       | KGF-N-3240-RH-EE | Z1, Z2, Z3                             | 14.9             | 3,350  | 32.4                               | 7,284  | 0.08                                | 30.7 | 28.3                | 6000                | 5.6            |                            |
| 40                      | 5    | E        | KGS-4005-023-RH                       | KGF-N-4005-RH-EE | Z1, Z2, Z3                             | 23.8             | 5,351  | 63.1                               | 14,185 | 0.08                                | 39.3 | 36.9                | 6000                | 9.0            |                            |
| 40                      | 10   | E        | KGS-4010-023-RH                       | KGF-N-4010-RH-EE | Z1, Z2, Z3                             | 38.0             | 8,544  | 69.1                               | 15,534 | 0.08                                | 39.3 | 34.1                | 6000                | 8.4            |                            |
| 50                      | 10   | E        | KGS-5010-023-RH                       | KGF-N-5010-RH-EE | Z1, Z2, Z3                             | 68.7             | 15,446 | 155.8                              | 35,025 | 0.08                                | 49.3 | 44.1                | 6000                | 13.5           |                            |
| 63                      | 10   | E        | KGS-6310-023-RH                       | KGF-N-6310-RH-EE | Z1, Z2, Z3                             | 76.0             | 17,087 | 197.0                              | 44,287 | 0.08                                | 62.3 | 57.1                | 6000                | 22.0           |                            |
| 80                      | 10   | E        | KGS-8010-050-RH                       | KGF-N-8010-RH-EE | Z1, Z2, Z3                             | 86.3             | 19,390 | 262.4                              | 58,993 | 0.08                                | 79.7 | 74.2                | 6000 <sup>(7)</sup> | 36.4           |                            |

(1) -P3 Accuracy Class is  $\pm 12\mu\text{m}/300\text{mm}$ . and is available upon request for most sizes.

(2) Thomson NEFF Rolled Ball Screws, Ball Nuts and End Blocks can be sold together as assemblies or separately as components (preloaded ball nuts sold only as an assembly).

(3) All ball screws and nuts are right-hand thread.

(4) Double nut pre-load systems (for up to 10% of dynamic load rating) are also available for all sizes. Contact customer service for more details.

(5) Dimensional information on bearing supports and standard end machining is available on page 154.

(6) Max. length includes 200mm on each end usable for end machining only. Max. travel length equals table value minus 400mm. Ends are soft annealed.

(7) T7 Lead Accuracy (P5 available but limited to 4000mm)



## Thomson NEFF Rolled Ball Screws — KGF-N Style Ball Nuts

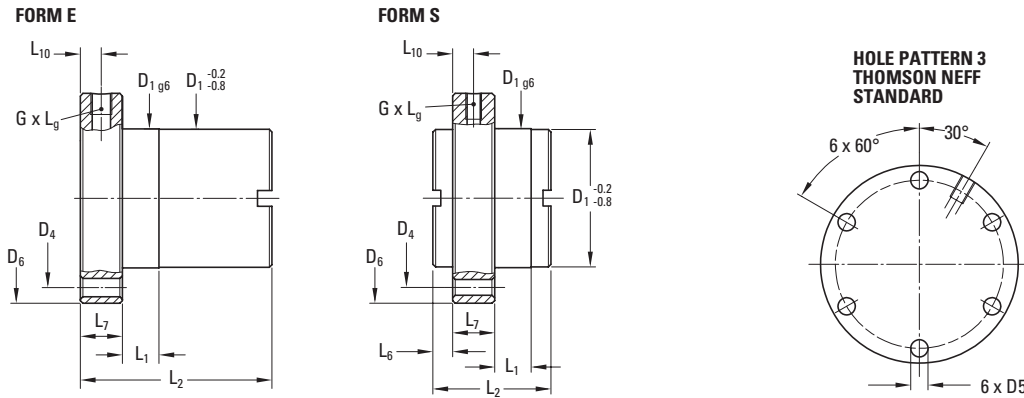

**MATERIAL:** 1.7131 (ESP65) / 1.3505 (100 Cr 6)

| Nominal Diameter (size) | Lead | Nut Specifications (mm) |                |                |                |                |                |                |                |                |                 |               |                 |                 |                    |
|-------------------------|------|-------------------------|----------------|----------------|----------------|----------------|----------------|----------------|----------------|----------------|-----------------|---------------|-----------------|-----------------|--------------------|
|                         |      | D <sub>1</sub>          | D <sub>4</sub> | D <sub>5</sub> | D <sub>6</sub> | L <sub>1</sub> | L <sub>2</sub> | L <sub>6</sub> | L <sub>7</sub> | L <sub>9</sub> | L <sub>10</sub> | Lube Hole (G) | No. of Circuits | Nut Weight (kg) | Ball Diameter (mm) |
| (mm)                    | (mm) | g6                      |                |                |                |                |                |                |                |                |                 |               |                 |                 |                    |
| 16                      | 5    | 28.0                    | 38.0           | 5.5            | 48.0           | 8.0            | 44.0           | —              | 12.0           | 8.0            | 6.0             | M 6           | 3               | 0.20            | 3.500              |
| 20                      | 5    | 32.0                    | 45.0           | 7.0            | 55.0           | 8.0            | 44.0           | —              | 12.0           | 8.0            | 6.0             | M 6           | 3               | 0.25            | 3.500              |
| 20                      | 20   | 35.0                    | 50.0           | 7.0            | 62.0           | 4.0            | 30.0           | 8.0            | 10.0           | 8.0            | 5.0             | M 6           | 4               | 0.25            | 3.500              |
| 20                      | 50   | 35.0                    | 50.0           | 7.0            | 62.0           | 10.0           | 56.0           | 9.0            | 10.0           | 8.0            | 5.0             | M 6           | 5               | 0.40            | 3.500              |
| 25                      | 5    | 38.0                    | 50.0           | 7.0            | 62.0           | 8.0            | 46.0           | —              | 14.0           | 8.0            | 7.0             | M 6           | 3               | 0.35            | 3.500              |
| 32                      | 5    | 45.0                    | 58.0           | 7.0            | 70.0           | 10.0           | 59.0           | —              | 16.0           | 8.0            | 8.0             | M 6           | 5               | 0.55            | 3.500              |
| 32                      | 10   | 53.0                    | 68.0           | 7.0            | 80.0           | 10.0           | 73.0           | —              | 16.0           | 8.0            | 8.0             | M 8x1         | 3               | 0.90            | 7.140              |
| 32                      | 40   | 53.0                    | 68.0           | 7.0            | 80.0           | 14.0           | 45.0           | 7.5            | 16.0           | 10.0           | 8.0             | M 6           | 4               | 0.45            | 3.500              |
| 40                      | 5    | 53.0                    | 68.0           | 7.0            | 80.0           | 10.0           | 59.0           | —              | 16.0           | 8.0            | 8.0             | M 6           | 5               | 0.70            | 3.500              |
| 40                      | 10   | 63.0                    | 78.0           | 9.0            | 95.0           | 10.0           | 73.0           | —              | 16.0           | 8.0            | 8.0             | M 8x1         | 3               | 1.20            | 7.140              |
| 50                      | 10   | 72.0                    | 90.0           | 11.0           | 110.0          | 10.0           | 97.0           | —              | 18.0           | 8.0            | 9.0             | M 8x1         | 5               | 2.00            | 7.140              |
| 63                      | 10   | 85.0                    | 105.0          | 11.0           | 125.0          | 10.0           | 99.0           | —              | 20.0           | 8.0            | 10.0            | M 8x1         | 5               | 2.80            | 7.140              |
| 80                      | 10   | 105.0                   | 125.0          | 14.0           | 145.0          | 10.0           | 101.0          | —              | 22.0           | 8.0            | 11.0            | M 8x1         | 5               | 3.90            | 7.144              |

## Thomson NEFF Rolled Ball Screws — KGM-D Style Ball Nuts

Standard Lead Accuracy:  $\pm 23\mu\text{m}/300\text{mm}^{(1)}$

Threaded ball nut and screw, offering low cost, high precision performance in applications typically requiring ground product.



**Quick Install**  
Available for Select Nuts

**KGM-D Style Nut**

### Internal Return Cylindrical Ball Nut and Screw

- Flexible solution for standard mounting
- Integral wiper included as standard
- Available in three preload classes (Type Z1, Z2, Z3)
  - Z1 – light preload to 1-2%
  - Z2 – no preload, clearance held to max indicated in table (standard unless specified)
  - Z3 – no preload, clearance held to max .05mm

| Nominal Diameter (size) | Lead | Nut Type | Ball Screw P/N <sup>(1)</sup> (2) (3) | Ball Nut P/N     | Available Preload Types <sup>(4)</sup> | Performance Data                         |        |  |        | Screw Specifications <sup>(5)</sup> |                |                |                            |              |
|-------------------------|------|----------|---------------------------------------|------------------|--|--|--------|--|--------|-------------------------------------|----------------|----------------|----------------------------|--------------|
|                         |      |          |                                       |                  |  | Dynamic Load Capacity (C <sub>am</sub> ) |        | Static Load Capacity (C <sub>o</sub> ) |        | Max. Axial Backlash                 | Major Diameter | Minor Diameter | Max. Length <sup>(6)</sup> | Screw Weight |
|                         |      |          |                                       |                  |  | (kN)                                     | (lbf)  | (kN)                                   | (lbf)  |                                     |                |                |                            |              |
| 12                      | 10   | S        | KGS-1210-023-RH                       | KGM-D-1210-RH-00 | Z1, Z2, Z3                             | 4.9                                      | 1,102  | 8.0                                    | 1,799  | 0.08                                | 11.5           | 10.1           | 3000                       | 0.8          |
| 16                      | 5    | E        | KGS-1605-023-RH                       | KGM-D-1605-RH-EE | Z1, Z2, Z3                             | 9.3                                      | 2,091  | 13.1                                   | 2,945  | 0.08                                | 15.3           | 12.9           | 6000                       | 1.3          |
| 16                      | 10   | E        | KGS-1610-023-RH                       | KGM-D-1610-RH-EE | Z1, Z2, Z3                             | 15.4                                     | 3,463  | 26.5                                   | 5,957  | 0.08                                | 15.2           | 13.0           | 6000                       | 1.3          |
| 20                      | 5    | E        | KGS-2005-023-RH                       | KGM-D-2005-RH-EE | Z1, Z2, Z3                             | 10.5                                     | 2,361  | 16.6                                   | 3,732  | 0.08                                | 19.3           | 16.9           | 6000                       | 2.0          |
| 25                      | 5    | E        | KGS-2505-023-RH                       | KGM-D-2505-RH-EE | Z1, Z2, Z3                             | 12.3                                     | 2,766  | 22.5                                   | 5,058  | 0.08                                | 24.3           | 21.9           | 6000                       | 3.3          |
| 25                      | 10   | E        | KGS-2510-023-RH                       | KGM-D-2510-RH-EE | Z1, Z2, Z3                             | 13.2                                     | 2,947  | 25.3                                   | 5,688  | 0.08                                | 24.3           | 21.9           | 6000                       | 3.3          |
| 25                      | 20   | S        | KGS-2520-023-RH                       | KGM-D-2520-RH-EE | Z1, Z2, Z3                             | 13.0                                     | 2,923  | 23.3                                   | 5,238  | 0.15                                | 24.4           | 22.0           | 6000                       | 3.3          |
| 25                      | 25   | S        | KGS-2525-023-RH                       | KGM-D-2525-RH-EE | Z1, Z2, Z3                             | 16.7                                     | 3,755  | 32.2                                   | 7,239  | 0.08                                | 24.3           | 22.0           | 6000                       | 3.3          |
| 25                      | 50   | S        | KGS-2550-023-RH                       | KGM-D-2550-RH-EE | Z1, Z2, Z3                             | 15.4                                     | 3,463  | 31.7                                   | 7,126  | 0.15                                | 23.9           | 21.5           | 6000                       | 3.3          |
| 32                      | 5    | E        | KGS-3205-023-RH                       | KGM-D-3205-RH-EE | Z1, Z2, Z3                             | 21.5                                     | 4,834  | 49.3                                   | 11,083 | 0.08                                | 31.3           | 28.9           | 6000                       | 5.6          |
| 40                      | 5    | E        | KGS-4005-023-RH                       | KGM-D-4005-RH-EE | Z1, Z2, Z3                             | 23.8                                     | 5,351  | 63.1                                   | 14,185 | 0.08                                | 39.3           | 36.9           | 6000                       | 9.0          |
| 40                      | 10   | E        | KGS-4010-023-RH                       | KGM-D-4010-RH-EE | Z1, Z2, Z3                             | 38.0                                     | 8,544  | 69.1                                   | 15,534 | 0.08                                | 39.3           | 34.1           | 6000                       | 8.4          |
| 40                      | 20   | E        | KGS-4020-023-RH                       | KGM-D-4020-RH-EE | Z1, Z2, Z3                             | 33.3                                     | 7,487  | 76.1                                   | 17,108 | 0.08                                | 39.5           | 35.9           | 6000                       | 9.0          |
| 40                      | 40   | S        | KGS-4040-023-RH                       | KGM-D-4040-RH-EE | Z1, Z2, Z3                             | 35.0                                     | 7,869  | 101.9                                  | 22,908 | 0.08                                | 38.7           | 36.3           | 6000                       | 9.0          |
| 50                      | 10   | E        | KGS-5010-023-RH                       | KGM-D-5010-RH-EE | Z1, Z2, Z3                             | 82.0                                     | 18,435 | 153.0                                  | 34,398 | 0.08                                | 49.6           | 44.1           | 6000                       | 13.5         |
| 63                      | 10   | E        | KGS-6310-023-RH                       | KGM-D-6310-RH-EE | Z1, Z2, Z3                             | 90.0                                     | 20,234 | 200.0                                  | 44,964 | 0.08                                | 62.6           | 57.2           | 6000                       | 22.1         |
| 63                      | 20   | E        | KGS-6320-023-RH                       | KGM-D-6320-RH-EE | Z1, Z2, Z3                             | 65.1                                     | 14,635 | 169.5                                  | 38,105 | 0.08                                | 62.6           | 57.2           | 6000                       | 22.0         |

(1) -P3 Accuracy Class is  $\pm 12\mu\text{m}/300\text{mm}$ . and is available upon request for most sizes.

(2) Thomson NEFF Rolled Ball Screws, Ball Nuts and End Blocks can be sold together as assemblies or separately as components (preloaded ball nuts sold only as an assembly).

(3) All ball screws and nuts are right-hand thread.

(4) Double nut pre-load systems (for up to 10% of dynamic load rating) are also available for all sizes. Contact customer service for more details.

(5) Dimensional information on bearing supports and standard end machining is available on page 154.

(6) Max. length includes 200mm on each end usable for end machining only. Max. travel length equals table value minus 400mm. Ends are soft annealed.

## Thomson NEFF Rolled Ball Screws — KGM-D Style Ball Nuts

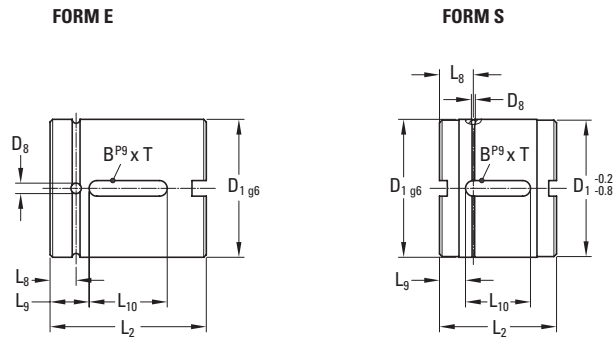

**MATERIAL:** 1.7131 (ESP65) / 1.3505 (100 Cr 6)

| Nominal Diameter<br>(size) | Lead | Nut Specifications (mm) |                |                |                |                |                 |       |                 |            |               |
|----------------------------|------|-------------------------|----------------|----------------|----------------|----------------|-----------------|-------|-----------------|------------|---------------|
|                            |      | D <sub>1</sub>          | D <sub>8</sub> | L <sub>2</sub> | L <sub>8</sub> | L <sub>9</sub> | L <sub>10</sub> | BxT   | No. of Circuits | Nut Weight | Ball Diameter |
| (mm)                       | (mm) | g6                      |                |                |                |                |                 |       |                 | (kg)       | (mm)          |
| 12                         | 10   | 24.0                    | 2.0            | 27.5           | 7.0            | 8.75           | 10.0            | 3x1.8 | 4               | 0.10       | 2.000         |
| 16                         | 5    | 28.0                    | 3.0            | 34.0           | 7.0            | 7.0            | 20.0            | 5x2   | 3               | 0.10       | 3.500         |
| 16                         | 10   | 28.0                    | 3.0            | 50.0           | 7.0            | 15.0           | 20.0            | 5x2   | 6               | 0.20       | 3.000         |
| 20                         | 5    | 36.0                    | 3.0            | 34.0           | 7.0            | 7.0            | 20.0            | 5x2   | 3               | 0.20       | 3.500         |
| 25                         | 5    | 40.0                    | 3.0            | 34.0           | 7.0            | 7.0            | 20.0            | 5x2   | 3               | 0.20       | 3.500         |
| 25                         | 10   | 40.0                    | 3.0            | 45.0           | 7.5            | 12.5           | 20.0            | 5x2   | 3               | 0.24       | 3.500         |
| 25                         | 20   | 40.0                    | 1.5            | 35.0           | 14.0           | 11.5           | 12.0            | 5x3   | 4               | 0.20       | 3.500         |
| 25                         | 25   | 40.0                    | 1.5            | 35.0           | 11.5           | 11.0           | 13.0            | 5x3   | 5               | 0.45       | 3.500         |
| 25                         | 50   | 40.0                    | 1.5            | 58.0           | 17.0           | 19.0           | 20.0            | 5x3   | 5               | 0.30       | 3.500         |
| 32                         | 5    | 50.0                    | 3.0            | 45.0           | 7.5            | 8.0            | 30.0            | 6x2.5 | 5               | 0.50       | 3.500         |
| 40                         | 5    | 63.0                    | 3.0            | 45.0           | 7.5            | 8.0            | 30.0            | 6x2.5 | 5               | 0.80       | 3.500         |
| 40                         | 10   | 63.0                    | 4.0            | 60.0           | 10.0           | 15.0           | 30.0            | 6x2.5 | 3               | 1.00       | 7.140         |
| 40                         | 20   | 63.0                    | 3.0            | 70.0           | 7.5            | 20.0           | 30.0            | 6x2.5 | 4               | 1.20       | 5.000         |
| 40                         | 40   | 63.0                    | 1.5            | 85.0           | 15.0           | 27.5           | 30.0            | 6x3.5 | 8               | 0.90       | 3.500         |
| 50                         | 10   | 75.0                    | 4.0            | 82.0           | 11.0           | 23.0           | 36.0            | 6x2.5 | 5               | 0.90       | 7.144         |
| 63                         | 10   | 90.0                    | 4.0            | 82.0           | 11.0           | 23.0           | 36.0            | 6x2.5 | 5               | 0.90       | 7.144         |
| 63                         | 20   | 95.0                    | 4.0            | 82.0           | 10.0           | 23.0           | 36.0            | 6x2.5 | 4               | 1.95       | 7.140         |

## Thomson NEFF Rolled Ball Screws — KGM-N Style Ball Nuts

Standard Lead Accuracy:  $\pm 23\mu\text{m}/300\text{mm}^{(1)}$

Threaded ball nut and screw, offering low cost, high precision performance in applications typically requiring ground product.



**KGM-N Style Nut**



**Quick Install**  
Available for Select Nuts

### Internal Return Cylindrical Ball Nut and Screw

- Flexible solution for non-standard mounting
- Integral wiper included as standard<sup>(5)</sup>
- Available in three preload classes (Type Z1, Z2, Z3)
  - Z1 – light preload to 1 – 2%
  - Z2 – no preload, clearance held to max indicated in table (standard unless specified)
  - Z3 – no preload, clearance held to max .05mm

| Nominal Diameter (size) | Lead | Nut Type | Ball Screw P/N <sup>(1) (2) (3)</sup> | Ball Nut P/N     | Available Preload Types <sup>(4)</sup> | Performance Data                   |        |                                |        | Screw Specifications <sup>(7)</sup> |                |                |                            |              |
|-------------------------|------|----------|---------------------------------------|------------------|--|------------------------------------|--------|--------------------------------|--------|-------------------------------------|----------------|----------------|----------------------------|--------------|
|                         |      |          |                                       |                  |  | Dynamic Load Capacity ( $C_{am}$ ) |        | Static Load Capacity ( $C_o$ ) |        | Max. Axial Backlash                 | Major Diameter | Minor Diameter | Max. Length <sup>(8)</sup> | Screw Weight |
|                         |      |          |                                       |                  |  | (kN)                               | (lbf)  | (kN)                           | (lbf)  |                                     |                |                |                            |              |
| 12                      | 5    | E        | KGS-1205-023-RH                       | KGM-N-1205-RH-00 | Z1, Z2, Z3                             | 4.4                                | 990    | 6.8                            | 1,529  | 0.08                                | 11.3           | 10.1           | 1500 <sup>(9)</sup>        | 0.8          |
| 20                      | 5    | E        | KGS-2005-023-RH                       | KGM-N-2005-RH-EE | Z1, Z2, Z3                             | 10.5                               | 2,361  | 16.6                           | 3,732  | 0.08                                | 19.3           | 16.9           | 6000                       | 2.0          |
| 20                      | 20   | S        | KGS-2020-023-RH                       | KGM-N-2020-RH-EE | Z1, Z2, Z3                             | 11.6                               | 2,608  | 18.4                           | 4,136  | 0.08                                | 19.3           | 16.9           | 6000                       | 2.0          |
| 20                      | 50   | S        | KGS-2050-023-RH                       | KGM-N-2050-RH-EE | Z1, Z2, Z3                             | 13.0                               | 2,923  | 24.6                           | 5,530  | 0.15                                | 18.9           | 16.5           | 6000                       | 2.0          |
| 25                      | 5    | E        | KGS-2505-023-RH                       | KGM-N-2505-RH-EE | Z1, Z2, Z3                             | 12.3                               | 2,766  | 22.5                           | 5,058  | 0.08                                | 24.3           | 21.9           | 6000                       | 3.3          |
| 32                      | 5    | E        | KGS-3205-023-RH                       | KGM-N-3205-RH-EE | Z1, Z2, Z3                             | 21.5                               | 4,834  | 49.3                           | 11,083 | 0.08                                | 31.3           | 28.9           | 6000                       | 5.6          |
| 32                      | 10   | E        | KGS-3210-023-RH                       | KGM-N-3210-RH-EE | Z1, Z2, Z3                             | 33.4                               | 7,509  | 54.5                           | 12,252 | 0.08                                | 32.5           | 27.3           | 6000                       | 5.6          |
| 32                      | 20   | E        | KGS-3220-023-RH                       | KGM-N-3220-RH-EE | Z1, Z2, Z3                             | 29.7                               | 6,678  | 59.8                           | 13,444 | 0.08                                | 31.5           | 27.9           | 6000                       | 5.6          |
| 32                      | 40   | S        | KGS-3240-023-RH                       | KGM-N-3240-RH-EE | Z1, Z2, Z3                             | 14.9                               | 3,350  | 32.4                           | 7,284  | 0.08                                | 30.7           | 28.3           | 6000                       | 5.6          |
| 40                      | 5    | E        | KGS-4005-023-RH                       | KGM-N-4005-RH-EE | Z1, Z2, Z3                             | 23.8                               | 5,351  | 63.1                           | 14,185 | 0.08                                | 39.3           | 36.9           | 6000                       | 9.0          |
| 50                      | 10   | E        | KGS-5010-023-RH                       | KGM-N-5010-RH-EE | Z1, Z2, Z3                             | 68.7                               | 15,446 | 155.8                          | 35,025 | 0.08                                | 49.3           | 44.1           | 6000                       | 13.5         |
| 50                      | 20   | E        | KGS-5020-023-RH                       | KGM-N-5020-RH-EE | Z1, Z2, Z3                             | 60.0                               | 13,490 | 136.3                          | 30,641 | 0.08                                | 49.3           | 44.1           | 6000                       | 13.5         |
| 63                      | 10   | E        | KGS-6310-023-RH                       | KGM-N-6310-RH-EE | Z1, Z2, Z3                             | 76.0                               | 17,087 | 197.0                          | 44,287 | 0.08                                | 62.3           | 57.1           | 6000                       | 22.0         |
| 80                      | 10   | E        | KGS-8010-050-RH                       | KGM-N-8010-RH-EE | Z1, Z2, Z3                             | 86.3                               | 19,402 | 262.4                          | 58,993 | 0.08                                | 79.7           | 74.2           | 6000 <sup>(10)</sup>       | 36.4         |

(1) -P3 Accuracy Class is  $\pm 12\mu\text{m}/300\text{mm}$ . and is available upon request for most sizes.

(2) Ball screws, ball nuts and end blocks can be sold together as assemblies or separately as components (preloaded ball nuts sold only as an assembly).

(3) All ball screws and nuts are right-hand thread.

(4) Double nut pre-load systems (for up to 10% of dynamic load rating) are also available for all sizes. Contact customer service for more details.

(5) 12x5 nut does not include wiper.

(6) D1 -0.2/-0.8 does not apply, therefore D1 -1.0/-1.5.

(7) Dimensional information on bearing supports and standard end machining is available on page 154.

(8) Max. length includes 200mm on each end usable for end machining only. Max. travel length equals table value minus 400mm. Ends are soft annealed.

(9) Max. length includes 100mm on each end usable for end machining only. Max. travel length equals table value minus 200mm. Ends are soft annealed.

(10) T7 Lead Accuracy (P5 available but limited to 4000mm)

## Thomson NEFF Rolled Ball Screws — KGM-N Style Ball Nuts

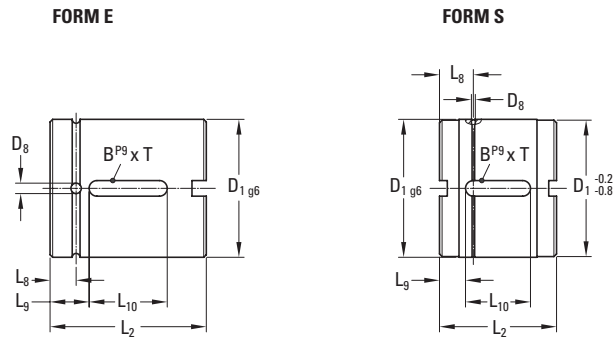

**MATERIAL:** 1.7131 (ESP65) / 1.3505 (100 Cr 6)

| Nominal Diameter<br>(size) | Lead | Nut Specifications (mm) |                |                |                |                |                 |       |                 |            |               |
|----------------------------|------|-------------------------|----------------|----------------|----------------|----------------|-----------------|-------|-----------------|------------|---------------|
|                            |      | D <sub>1</sub>          | D <sub>8</sub> | L <sub>2</sub> | L <sub>8</sub> | L <sub>9</sub> | L <sub>10</sub> | BxT   | No. of Circuits | Nut Weight | Ball Diameter |
| (mm)                       | (mm) | g6                      |                |                |                |                |                 |       |                 | (kg)       | (mm)          |
| 12                         | 5    | 20.0 <sup>(5)</sup>     | —              | 24.0           | —              | 5.0            | 14.0            | 3x1.8 | 3               | 0.03       | 2.000         |
| 20                         | 5    | 32.0                    | 3.0            | 34.0           | 7.0            | 7.0            | 20.0            | 5x2   | 3               | 0.10       | 3.500         |
| 20                         | 20   | 35.0                    | 1.5            | 30.0           | 11.5           | 9.0            | 12.0            | 5x3   | 4               | 0.14       | 3.500         |
| 20                         | 50   | 35.0                    | 1.5            | 56.0           | 16.0           | 18.0           | 20.0            | 5x3   | 5               | 0.30       | 3.500         |
| 25                         | 5    | 38.0                    | 3.0            | 34.0           | 7.0            | 7.0            | 20.0            | 5x2   | 3               | 0.15       | 3.500         |
| 32                         | 5    | 45.0                    | 3.0            | 45.0           | 7.5            | 8.0            | 30.0            | 6x2.5 | 5               | 0.30       | 3.500         |
| 32                         | 10   | 53.0                    | 4.0            | 60.0           | 10.0           | 15.0           | 30.0            | 6x2.5 | 3               | 0.55       | 7.140         |
| 32                         | 20   | 53.0                    | 3.0            | 70.0           | 7.5            | 20.0           | 30.0            | 6x2.5 | 4               | 0.80       | 5.000         |
| 32                         | 40   | 53.0 <sup>(6)</sup>     | 1.5            | 45.0           | 13.0           | 10.0           | 25.0            | 6x4   | 4               | 0.46       | 3.500         |
| 40                         | 5    | 53.0                    | 3.0            | 45.0           | 7.5            | 8.0            | 30.0            | 6x2.5 | 5               | 0.60       | 3.500         |
| 50                         | 10   | 72.0                    | 4.0            | 82.0           | 11.0           | 23.0           | 36.0            | 6x2.5 | 5               | 1.10       | 7.140         |
| 50                         | 20   | 85.0                    | 4.0            | 82.0           | 10.0           | 23.0           | 36.0            | 6x2.5 | 4               | 1.40       | 7.140         |
| 63                         | 10   | 85.0                    | 4.0            | 82.0           | 11.0           | 23.0           | 36.0            | 6x2.5 | 5               | 1.45       | 7.140         |
| 80                         | 10   | 105.0                   | 4.0            | 82.0           | 11.0           | 23.0           | 36.0            | 8x3   | 5               | 3.90       | 7.144         |

**NOTES:**

A large grid of graph paper for taking notes, consisting of 30 columns and 40 rows of small squares.

## Precision Plus Ball Screws — Metric Series



**Precision Plus Ball Screw Assemblies** are our highest precision product, with standard lead accuracies of 12 microns/ 300mm. These ball screw assemblies feature our FL-style ball nut, precisely preloaded to customer specifications. This unique nut design provides high repeatability and high stiffness for the most demanding ball screw applications. Each nut comes standard with an integral plastic wiper to protect against chips and other debris. Precision Plus Ball Screws are ideal for applications requiring high repeatability and high stiffness (e.g., high precision machine tool).

Need a quote or have a question about an application?  
Contact us in North America at:

Phone: 540-633-3549

Fax: 540-639-4162

Email: [thomson@thomsonlinear.com](mailto:thomson@thomsonlinear.com)

## Precision Plus Ball Screws — Metric Series

Standard Lead Accuracy:  $\pm 12\mu\text{m}/300\text{mm}$

Flanged ball nut and screw assembly, offering the highest level of accuracy, repeatability and stiffness.



### Internal Return Flanged Ball Nut and Screw

- Excellent accuracy, repeatability and stiffness
- Features Z0 Type preload (range from 2% to 13%, to customer specification)
- Nut stiffness based on 10% preload ( $F = 10\% \times C_{am}$ )
- Integral wiper and flange included as standard
- Additional sizes available in diameters up to 160mm. Contact us for more details.

| Nominal Diameter (size) | Lead | Nut Type | Ball Screw and Nut Assembly P/N <sup>(1)</sup> (2) | Performance Data                   |        |                                |        |                      |                     |                     | Screw Specifications <sup>(3)</sup> |                |                            |              |
|-------------------------|------|----------|--|------------------------------------|--------|--------------------------------|--------|----------------------|---------------------|---------------------|-------------------------------------|----------------|----------------------------|--------------|
|                         |      |          |  | Dynamic Load Capacity ( $C_{am}$ ) |        | Static Load Capacity ( $C_o$ ) |        | Minimum Stiffness    | Max. Axial Backlash | No. of Loaded Turns | Major Diameter                      | Minor Diameter | Max. <sup>(4)</sup> Length | Screw Weight |
|                         |      |          |  | (kN)                               | (lbf)  | (kN)                           | (lbf)  | (kN/ $\mu\text{m}$ ) | (mm)                | (turns)             | (mm)                                | (mm)           | (mm)                       | (kg/m)       |
| 16                      | 5    | FL       | <b>7832835</b>                                     | 6.7                                | 1,506  | 7.2                            | 1,619  | 0.16                 | 0.00                | 2 + 2               | 15.6                                | 12.7           | 3000                       | 1.2          |
| 20                      | 5    | FL       | <b>7832838</b>                                     | 11.5                               | 2,585  | 15.5                           | 3,485  | 0.30                 | 0.00                | 3 + 3               | 19.6                                | 16.7           | 4000                       | 2.0          |
| 25                      | 5    | FL       | <b>7832841</b>                                     | 12.6                               | 2,833  | 19.1                           | 4,294  | 0.38                 | 0.00                | 3 + 3               | 24.5                                | 21.7           | 4100                       | 3.3          |
| 32                      | 5    | FL       | <b>7832862</b>                                     | 19.3                               | 4,339  | 36.4                           | 8,183  | 0.60                 | 0.00                | 4 + 4               | 31.6                                | 28.7           | 4100                       | 5.6          |
| 32                      | 10   | FL       | <b>7832844</b>                                     | 26.4                               | 5,935  | 39.0                           | 8,768  | 0.49                 | 0.00                | 3 + 3               | 31.6                                | 27.1           | 4100                       | 5.3          |
| 40                      | 5    | FL       | <b>7832847</b>                                     | 26.3                               | 5,912  | 59.2                           | 13,309 | 0.89                 | 0.00                | 5 + 5               | 39.6                                | 36.7           | 4100                       | 9.0          |
| 40                      | 10   | FL       | <b>7832850</b>                                     | 64.9                               | 14,590 | 109.0                          | 24,504 | 0.94                 | 0.00                | 4 + 4               | 39.6                                | 34.0           | 4100                       | 8.3          |
| 50                      | 10   | FL       | <b>7832853</b>                                     | 69.0                               | 15,511 | 142.2                          | 31,966 | 1.18                 | 0.00                | 4 + 4               | 49.5                                | 43.0           | 4100                       | 13.5         |
| 63                      | 10   | FL       | <b>7832856</b>                                     | 93.8                               | 21,087 | 229.7                          | 51,639 | 1.74                 | 0.00                | 5 + 5               | 62.5                                | 56.9           | 4100                       | 22.0         |

(1) End Blocks can be sold together as assemblies or separately as components (preloaded ball nuts sold only as an assembly).

(2) All ball screws and nuts are right-hand thread.

(3) Dimensional information on bearing supports and standard end machining is available on page 154.

(4) Longer screws are available (up to 11000) for some sizes at P5 Accuracy Class (23 $\mu\text{m}/300\text{mm}$ ).



## Precision Plus Ball Screws — Metric Series

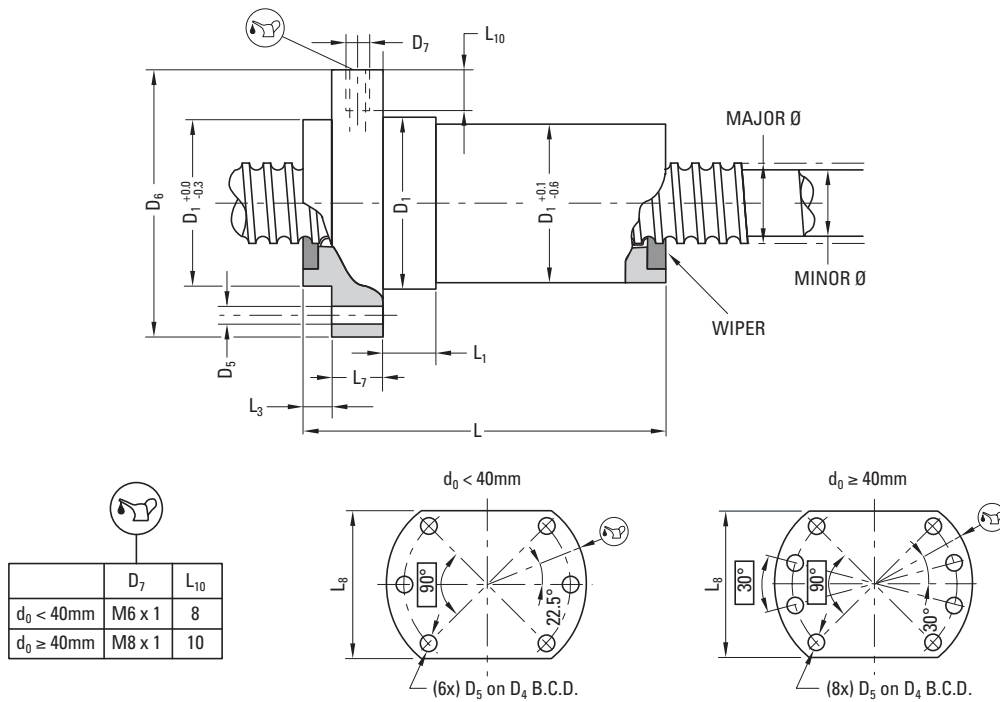

| Nominal Diameter (size) | Lead | Nut Specifications (mm) |                |                |                |       |                |                |                |                |     | Nut Weight (kg) | Ball Diameter (mm) |
|-------------------------|------|-------------------------|----------------|----------------|----------------|-------|----------------|----------------|----------------|----------------|-----|-----------------|--------------------|
|                         |      | D <sub>1</sub>          | D <sub>4</sub> | D <sub>5</sub> | D <sub>6</sub> | L     | L <sub>1</sub> | L <sub>3</sub> | L <sub>7</sub> | L <sub>8</sub> |     |                 |                    |
| (mm)                    | (mm) | g6                      |                | H13            | h13            |       |                |                | h13            | h13            |     |                 |                    |
| 16                      | 5    | 28.0                    | 38.0           | 5.5            | 48.0           | 55.0  | 10.0           | 5.5            | 10.0           | 40.0           | 0.3 | 3.500           |                    |
| 20                      | 5    | 36.0                    | 47.0           | 6.6            | 58.0           | 68.5  | 10.0           | 5.5            | 10.0           | 44.0           | 0.4 | 3.500           |                    |
| 25                      | 5    | 40.0                    | 51.0           | 6.6            | 62.0           | 69.5  | 10.0           | 6.0            | 10.0           | 48.0           | 0.4 | 3.500           |                    |
| 32                      | 5    | 50.0                    | 65.0           | 9.0            | 80.0           | 83.0  | 12.0           | 6.0            | 12.0           | 62.0           | 0.7 | 3.500           |                    |
| 32                      | 10   | 50.0                    | 65.0           | 9.0            | 80.0           | 105.5 | 12.0           | 6.0            | 12.0           | 62.0           | 0.8 | 3.500           |                    |
| 40                      | 5    | 63.0                    | 78.0           | 9.0            | 93.0           | 97.0  | 14.0           | 7.0            | 14.0           | 70.0           | 1.3 | 3.500           |                    |
| 40                      | 10   | 63.0                    | 78.0           | 9.0            | 93.0           | 142.0 | 14.0           | 7.0            | 14.0           | 70.0           | 1.5 | 7.144           |                    |
| 50                      | 10   | 75.0                    | 93.0           | 11.0           | 110.0          | 144.0 | 16.0           | 7.0            | 16.0           | 85.0           | 2.2 | 7.144           |                    |
| 63                      | 10   | 90.0                    | 108.0          | 11.0           | 125.0          | 166.0 | 18.0           | 7.0            | 18.0           | 95.0           | 3.3 | 7.144           |                    |

**NOTES:**

A large grid of graph paper for taking notes, consisting of 30 columns and 40 rows of small squares.

# Ball Splines



A Thomson Precision ball spline consists of mating inner and outer races containing concave axial races and a complement of bearing balls. The balls provide the only physical contact between the inner and outer races. Unlimited rolling travel is achieved by diverting the path of the balls at the extremes of the outer race into the end cap return circuit. This provides a closed loop through which the balls recirculate when the races are displaced axially relative to each other. The bearing balls resist radial displacement resulting from torque loads.

- Efficiency — coefficient of friction .007 maximum
- Hardness — minimum of RC 56 in ball race
- Lash — .005 inch maximum standard play perpendicular to rotational axis

Need a quote or have a question about an application?  
Contact us in North America at:

Phone: 540-633-3549

Fax: 540-639-4162

Email: [thomson@thomsonlinear.com](mailto:thomson@thomsonlinear.com)

## Precision Rolled Ball Splines

0.375 in to 6.000 in Diameter



### Inner and Outer Spline Races

- Offers high speed, anti-friction linear motion under high torsional loads
- All units available with and without keyway
- **All sizes stocked for quick delivery**

| Nominal Diameter<br>(in.) | Active Races <sup>(1)(2)</sup> | Inner Race P/N | Outer Race P/N (w/o keyway) | Outer Race P/N (w/ keyway) | Performance Data                                    |   |                                  |                                    | Inner Race Specifications |                          |                         |
|---------------------------|--------------------------------|----------------|-----------------------------|----------------------------|---|---|----------------------------------|------------------------------------|---------------------------|--------------------------|-------------------------|
|                           |                                |                |                             |                            | Dynamic Load Capacity (C <sub>am</sub> )<br>(in-lb) | Static Torque Capacity (C <sub>o</sub> )<br>(in-lb) | Max. Diametral Backlash<br>(in.) | Max. Angular Backlash<br>(radians) | Root Diameter<br>(in.)    | Standard Length<br>(in.) | Inner Weight<br>(lb/in) |
| 0.375                     | 3                              | 5707547        | 5706900                     | 7828127                    | 200   | 626   | 0.005                            | 0.0266                             | 0.200                     | 24                       | 0.02                    |
| 0.625                     | 3                              | 5707548        | 5707445                     | 7828128                    | 585   | 1,770   | 0.005                            | 0.0160                             | 0.425                     | 48                       | 0.06                    |
| 0.625                     | 6                              | 5707548        | 5708943                     | 7828129                    | 1,170   | 3,540   | 0.005                            | 0.0160                             | 0.425                     | 48                       | 0.06                    |
| 1.000                     | 3                              | 5706084        | 5707472                     | 7828130                    | 1,300   | 3,900   | 0.005                            | 0.0100                             | 0.800                     | 144                      | 0.17                    |
| 1.000                     | 6                              | 5706084        | 5708944                     | 7828131                    | 2,600   | 7,800   | 0.005                            | 0.0100                             | 0.800                     | 144                      | 0.17                    |
| 1.500                     | 3                              | 5706388        | 5707528                     | 7828132                    | 4,200   | 11,588  | 0.005                            | 0.0067                             | 1.230                     | 144                      | 0.4                     |
| 1.500                     | 6                              | 5706388        | 5708945                     | 7828133                    | 8,400   | 23,176  | 0.005                            | 0.0067                             | 1.230                     | 144                      | 0.4                     |
| 2.000                     | 3                              | 5706436        | 5707530                     | 7828134                    | 8,000   | 20,138  | 0.005                            | 0.0050                             | 1.670                     | 144                      | 0.75                    |
| 2.000                     | 6                              | 5706436        | 5708946                     | 7828135                    | 16,000  | 40,276  | 0.005                            | 0.0050                             | 1.670                     | 144                      | 0.75                    |
| 2.500                     | 3                              | 5706484        | 5707532                     | 7828136                    | 13,500  | 36,625  | 0.005                            | 0.0040                             | 2.100                     | 144                      | 1.17                    |
| 2.500                     | 6                              | 5706484        | 5708947                     | 7828137                    | 27,000  | 62,250  | 0.005                            | 0.0040                             | 2.100                     | 144                      | 1.17                    |
| 4.062                     | 6                              | 5702204        | 5708330                     | 7828138                    | 57,000  | 140,000   | 0.005                            | 0.0025                             | 3.660                     | 144                      | 3.13                    |
| 6.000                     | 8                              | 5704982        | 5704798                     | 7828140                    | 214,700   | 584,000   | 0.007                            | 0.0023                             | 5.470                     | 72                       | 7.01                    |

(1) Dimensional information on bearing supports and standard end machining is available on page 154.

(2) Information on required lubrication is on page 233.

## Precision Rolled Ball Splines

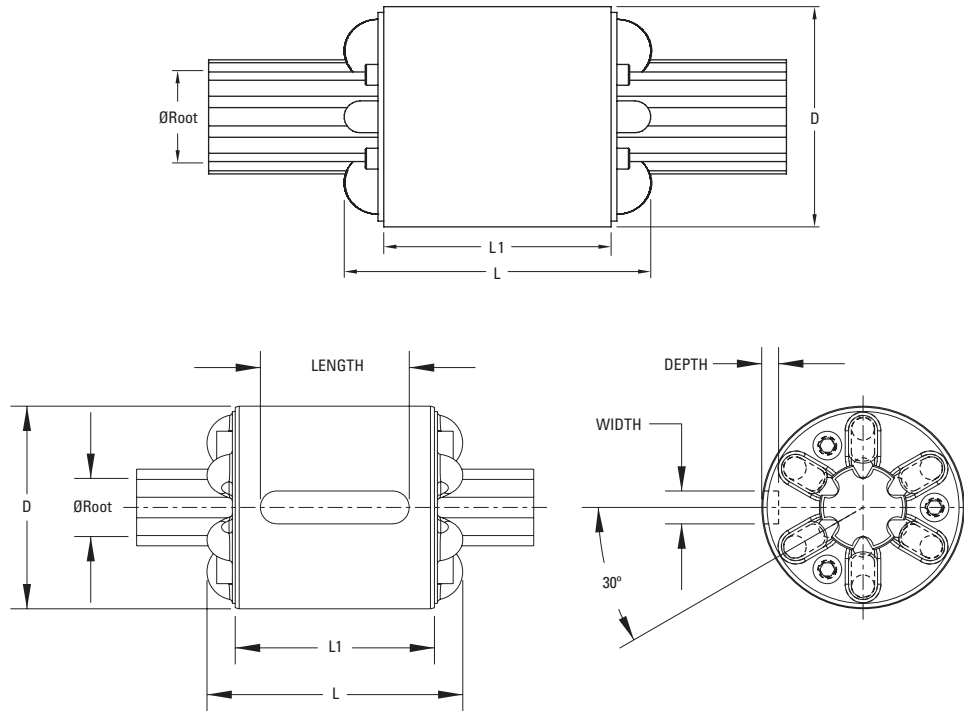

| Nominal Diameter | Active Races | Outer Race Specifications |       |       |  |              |               |
|------------------|--------------|---------------------------|-------|-------|--|--------------|---------------|
|                  |              | D (max.)                  | L     | L1    | Keyway Dimensions (Optional)<br>(Width x Depth x Length) | Outer Weight | Ball Diameter |
| (in.)            |              | (in.)                     | (in.) | (in.) | (in.)  | (lb)         | (in.)         |
| 0.375            | 3            | 1.161                     | 1.589 | 1.099 | 0.187 x 0.093 x 1.000                                    | 0.25         | 0.156         |
| 0.625            | 3            | 1.531                     | 2.035 | 1.505 | 0.250 x 0.125 x 1.125                                    | 0.37         | 0.187         |
| 0.625            | 6            | 1.531                     | 2.035 | 1.505 | 0.250 x 0.125 x 1.125                                    | 0.37         | 0.187         |
| 1.000            | 3            | 1.906                     | 2.598 | 2.068 | 0.250 x 0.125 x 1.625                                    | 0.92         | 0.187         |
| 1.000            | 6            | 1.906                     | 2.598 | 2.068 | 0.250 x 0.125 x 1.625                                    | 0.92         | 0.187         |
| 1.500            | 3            | 2.693                     | 3.719 | 3.005 | 0.250 x 0.125 x 2.000                                    | 3.33         | 0.250         |
| 1.500            | 6            | 2.693                     | 3.719 | 3.005 | 0.375 x 0.187 x 2.000                                    | 3.33         | 0.250         |
| 2.000            | 3            | 3.427                     | 4.022 | 3.130 | 0.250 x 0.125 x 2.500                                    | 5.42         | 0.312         |
| 2.000            | 6            | 3.427                     | 4.022 | 3.130 | 0.500 x 0.219 x 2.500                                    | 5.42         | 0.312         |
| 2.500            | 3            | 4.170                     | 4.426 | 3.380 | 0.250 x 0.125 x 3.000                                    | 7.50         | 0.375         |
| 2.500            | 6            | 4.170                     | 4.426 | 3.380 | 0.500 x 0.250 x 3.000                                    | 7.50         | 0.375         |
| 4.062            | 6            | 5.6245                    | 5.495 | 4.500 | 1.000 x 0.500 x 3.500                                    | 14.50        | 0.375         |
| 6.000            | 8            | 8.625                     | 7.495 | 5.995 | 1.000 x 0.500 x 5.500                                    | 51.52        | 0.500         |

**NOTES:**

A large grid of graph paper for taking notes, consisting of 30 columns and 40 rows of small squares.

# Bearing Supports/End Machining



## Table of Contents

| <b>Description</b>             | <b>Page</b> |
|--------------------------------|-------------|
| Product Overview .....         | 144         |
| Quick Install Assemblies ..... | 147         |
| BK/BF Supports .....           | 154         |
| FK/FF Supports .....           | 160         |
| MK Supports .....              | 166         |
| WK Supports .....              | 168         |
| QK/QF Supports .....           | 172         |

Need a quote or have a question about an application? Contact us in North America at:

Phone: 540-633-3549

Fax: 540-639-4162

Email: [thomson@thomsonlinear.com](mailto:thomson@thomsonlinear.com)

## Bearing Supports/End Machining Product Overview

**Thomson Bearing Supports** — complete package for simple mounting of Thomson ball screw and ball spline assemblies. Flange and Base mounts available with dual angular contact bearings or floating radial bearing.

- Rugged steel construction
- Low profile, compact design
- Base or Flange mounting configurations
- Pre-assembled and ready for installation
- Available off-the-shelf

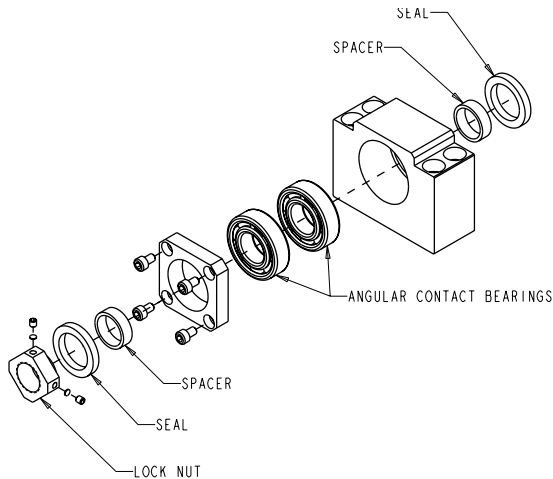

**BK Bearing Support<sup>(1)(2)</sup>**

The base mounted BK Bearing Support contains an angular contact bearing pair for increased stiffness and axial load capacity. Design dimensions fit standard Type BK or BK1 end machining.

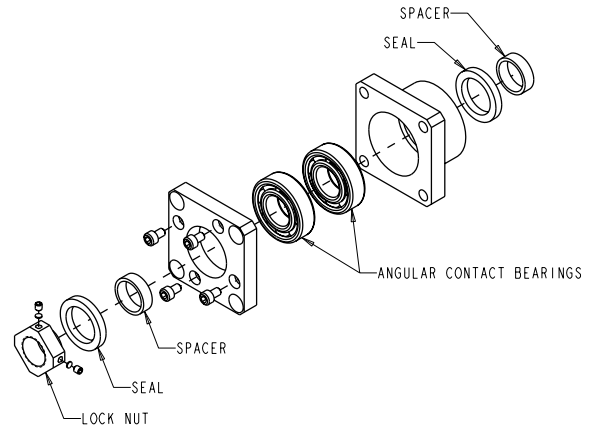

**FK Bearing Support<sup>(1)(2)</sup>**

The flange mounted FK Bearing Support contains an angular contact bearing pair for increased stiffness and axial load capacity. Design dimensions fit standard Type FK or FK1 end machining.

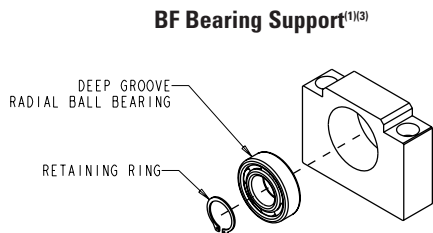

**BF Bearing Support<sup>(1)(3)</sup>**

Base mounted BF Bearing Support contains a floating radial bearing to allow axial shaft movement. Design dimensions fit standard Type BF or BF1 end machining.

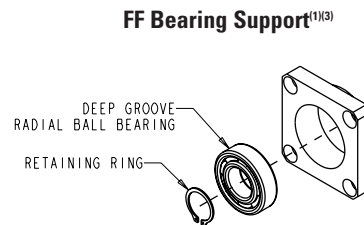

**FF Bearing Support<sup>(1)(3)</sup>**

The flange mounted FF Bearing Support contains a floating radial bearing to allow axial shaft movement. Design dimensions fit standard Type FF or FF1 end machining.

(1) BK and FK supports are classified as “fixed” and BF and FF supports are classified as “simple” for purposes of critical speed and column strength calculations.

(2) Locknut included in assembly

(3) Retaining ring included in assembly



## Bearing Supports/End Machining Product Overview

**Thomson Bearing Supports** — a unitized package for simple mounting of Thomson ball screw and ball spline assemblies. Both “Floating” and “Fixed” style bearing supports are available.

- Rugged steel construction
- Low profile, compact design
- Foot or face mounting
- Pre-assembled and ready for installation
- Available off-the-shelf for quick building convenience

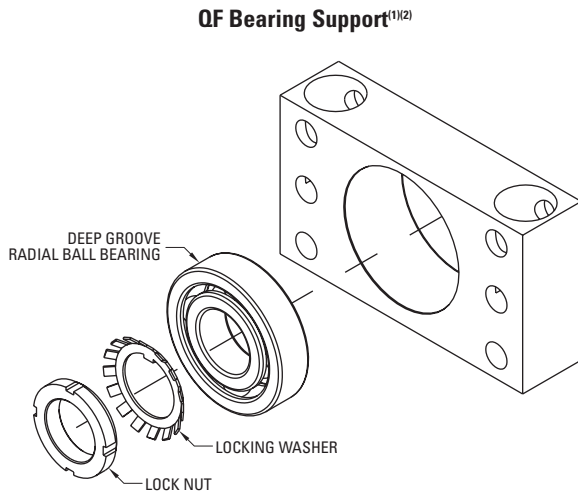

The QF Bearing Support provides a single deep groove radial ball bearing. Design dimensions fit standard Type QF or QF1 end machining.

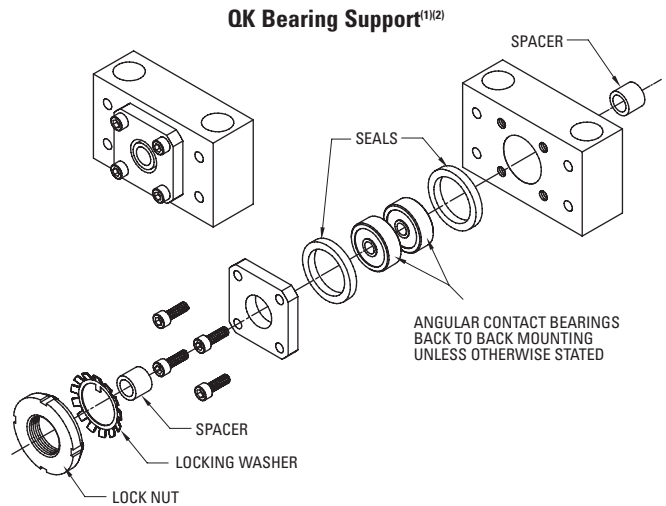

The QK Bearing Support contains high angular contact bearings arranged in a back-to-back (DB) configuration for high stiffness. Design dimensions fit standard Type QK or QK1 end machining.

### MK Bearing Support<sup>(3)</sup>

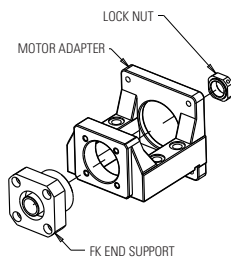

Base mounted NEMA 23 or 34 motor mount. Design dimensions fit standard Type FK end machining.

### WK Bearing Support<sup>(3)</sup>

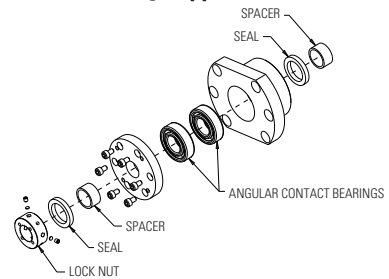

Heavy duty flange mounted WK support contains higher load capacity bearings. Design dimensions fit standard WK or WK1 end machining.

(1) QK, MK, and WK supports are classified as “fixed” and QF supports are classified as “simple” for purposes of critical speed and column strength calculations.

(2) Installation accessories (locknut and washer) included for complete assembly.

(3) Locknut included in assembly

## Bearing Supports Overview

| Inch Series Ball Screws |         |         |         |         |         |         |         |         |
|-------------------------|---------|---------|---------|---------|---------|---------|---------|---------|
| Dia. x Lead             | BK      | BF      | FK      | FF      | QK      | QF      | MK      | WK      |
| 0.500                   | 7833360 | 7833368 | 7833377 | 7833384 | 7828282 | 7833291 | 7833685 | -       |
| 0.631                   | 7833361 | 7833369 | 7833378 | 7833385 | 7824154 | 7833256 | 7833686 | -       |
| 0.750                   | 7833362 | 7833370 | 7833379 | 7833386 | 7824155 | 7833259 | 7833687 | -       |
| 0.875                   | 7833363 | 7833371 | 7833380 | 7833387 | 7824156 | 7833262 | -       | 7833595 |
| 1.000                   | 7833364 | 7833372 | 7833381 | 7833388 | 7824157 | 7833265 | 7833690 | 7833596 |
| 1.171                   | 7833364 | 7833372 | 7833381 | 7833388 | 7824157 | 7833265 | 7833690 | 7833596 |
| 1.150                   | 7833365 | 7833373 | 7833382 | 7833389 | 7824158 | 7833268 | -       | 7833597 |
| 1.250                   | 7833365 | 7833373 | 7833382 | 7833389 | 7824158 | 7833268 | -       | 7833597 |
| 1.500 x 0.473 & 1.000   | 7833365 | 7833373 | 7833382 | 7833389 | 7824158 | 7833268 | -       | 7833597 |
| 1.500                   | 7833366 | 7833374 | 7833383 | 7833390 | 7824159 | 7833270 | -       | 7833599 |
| 1.750                   | 7833367 | 7833375 | -       | -       | 7829554 | 7833273 | -       | 7833602 |
| 2.000                   | 7833367 | 7833375 | -       | -       | 7824160 | 7833276 | -       | -       |
| 2.250                   |         |         |         |         | 7824160 | 7833276 | -       | -       |
| 2.500                   | -       | -       | -       | -       | 7824161 | 7833279 | -       | -       |

| Metric Ball Screws |         |         |         |         |         |         |         |         |
|--------------------|---------|---------|---------|---------|---------|---------|---------|---------|
| Dia. x Lead        | BK      | BF      | FK      | FF      | QK      | QF      | MK      | WK      |
| 12                 | 7833391 | 7833398 | 7833405 | 7833411 | 7829546 | 7833292 | 7833700 | -       |
| 16                 | 7833392 | 7833399 | 7833406 | 7833412 | 7829547 | 7833282 | 7833701 | -       |
| 20                 | 7833393 | 7833400 | 7833407 | 7833413 | 7829548 | 7833283 | 7833702 | -       |
| 25                 | 7833394 | 7833401 | 7833408 | 7833414 | 7829549 | 7833284 | 7833703 | 7833614 |
| 32                 | 7833395 | 7833402 | 7833409 | 7833415 | 7829550 | 7833285 | -       | 7833615 |
| 40                 | 7833396 | 7833403 | 7833410 | 7833416 | 7829551 | 7833286 | -       | 7833617 |
| 50                 | 7833397 | 7833404 | -       | -       | 7829552 | 7833287 | -       | 7833621 |
| 63                 | -       | -       | -       | -       | 7829553 | 7833288 | -       | -       |

| Ball Splines |         |         |         |         |         |         |         |         |
|--------------|---------|---------|---------|---------|---------|---------|---------|---------|
| Nominal Size | BK      | BF      | FK      | FF      | QK      | QF      | MK      | WK      |
| 0.625        | 7833360 | 7833368 | 7833377 | 7833384 | 7828282 | 7833291 | 7833685 | -       |
| 1.000        | 7833364 | 7833372 | 7833381 | 7833388 | 7824157 | 7833265 | 7833690 | 7833596 |
| 1.500        | 7833365 | 7833373 | 7833382 | 7833389 | 7824159 | 7833270 | -       | 7833597 |
| 2.000        | 7833367 | 7833375 | -       | -       | 7829554 | 7833273 | -       | 7833602 |
| 2.500        | -       | -       | -       | -       | 7824161 | 7833279 | -       | -       |

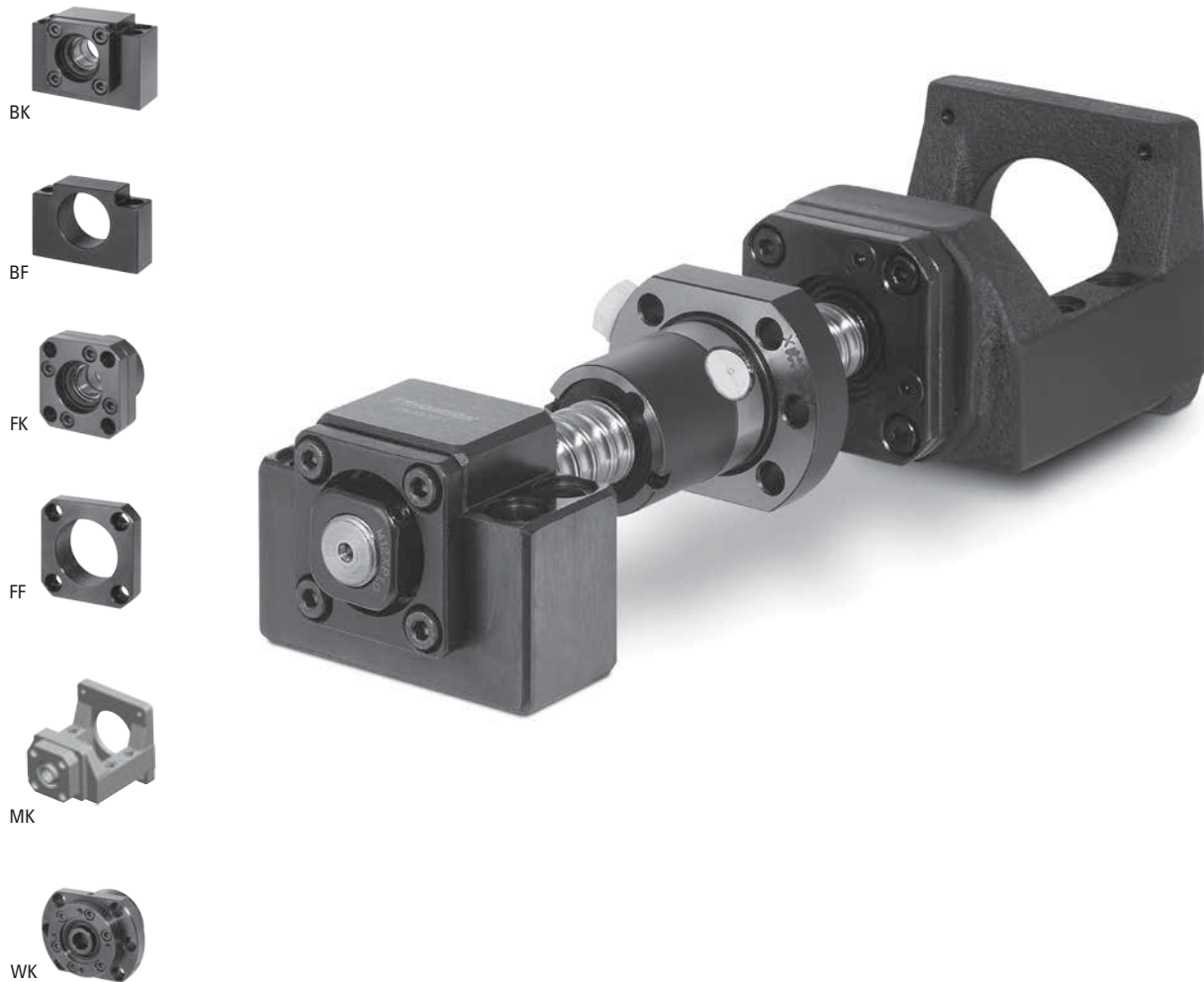

## Quick-Install Engineered Ball Screw Assemblies

### Get the 'just-right' fit

- Step by step selection assistance based on application parameters
- New configurations available
  - MK Supports - NEMA motor supports (Size 23 and 34)
  - WK Supports - Heavy duty supports for demanding applications

### Speed and simplify installation

- Pre-engineered assemblies to meet your system requirements
- Integrated ball screw and supports with motor ready mounting option

### Drop in replacements, fast delivery

- Popular ball screw assemblies and accessories available fast for replacement installations
- Additional configurations and sizes available upon request
- Industry-leading delivery times on all ball screw assemblies

## How to Select an Inch Series Ball Screw Assembly

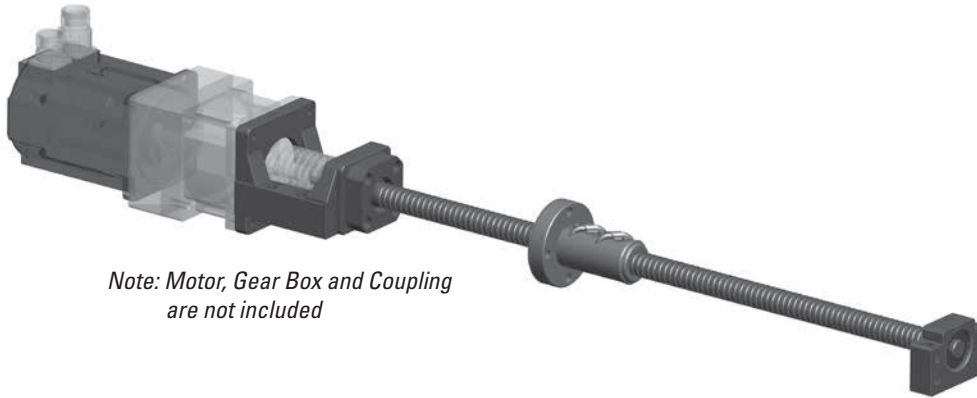







Note: Motor, Gear Box and Coupling are not included

### Step 1 - Select ball screw diameter based on load capacity and mounting configuration

- Table below indicates maximum axial load that selected ball nut diameter and end configuration can support
- Select a ball screw diameter / end support configuration with a load capacity exceeding application requirement

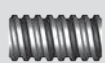

**Table 1 - End Support Axial Load Capacity (lbs)**

| Ball Screw Dia. |  BK - BK |  BK - BF |  FK - FK |  FK - FF |  MK - BK |  MK - BF |  WK - WK |
|-----------------|---|---|---|---|--|---|---|
| 0.500 in        | 860   | 430   | 860   | 430   | 860  | 430   | -   |
| 0.631 in        | 957   | 478   | 957   | 478   | 957  | 478   | -   |
| 0.750 in        | 1,058   | 529   | 1,058   | 529   | 1,058  | 529   | -   |
| 0.875 in        | 1,821   | 910   | 1,821   | 910   | -  | -   | 9,877   |
| 1.000 in        | 1,887   | 944   | 2,588   | 1,294   | 2,238  | 1,294   | 9,877   |
| 1.150 in        | 3,126   | 1,563   | 3,126   | 1,563   | -  | -   | 12,831  |
| 1.500 in        | 4,140   | 2,070   | 4,140   | 2,070   | -  | -   | 13,139  |
| 2.000 in        | 8,086   | 4,043   | -   | -   | -  | -   | 14,330  |

### Step 2 - Select lead

- Select preload if zero lash is required
- Select lead based on required speed
- Linear speed (in/min) = (RPM) x (Lead)







**Table 2 - Ball Nut Part Number**

|  Dia. x Lead |  Standard Nut Part Number |  Preload Nut Part Number | Maximum Screw Length (in) |
|---|--|---|---------------------------|
| .500 x .200   | 8105-448-013   | 8105-448-008  | 72.000                    |
| .500 x .500   | 8105-448-014   | -   | 72.000                    |
| .631 x .200   | 8106-448-022   | 8106-448-012  | 144.000                   |
| .631 x 1.000  | 7826713  | 7827531   | 96.000                    |
| .750 x .200   | 8107-448-018   | 8107-448-025  | 144.000                   |
| .750 x .500   | 8107-448-014   | 8107-448-011  | 144.000                   |
| .875 x .200   | 5708277  | -   | 144.000                   |
| 1.000 x .250  | 8110-448-055   | 5704167   | 288 / 240                 |
| 1.000 x .500  | 8110-448-022   | 8110-448-016  | 288.000                   |
| 1.000 x 1.000   | 8110-448-086   | -   | 288.000                   |
| 1.150 x .200  | 8111-448-006   | 8111-448-004  | 288.000                   |
| 1.500 x .250  | 7833233  | 7833234   | 240.000                   |
| 1.500 x .473  | 5707513  | -   | 240.000                   |
| 1.500 x .500  | 8115-448-016   | 8115-448-006  | 288.000                   |
| 1.500 x 1.000   | 5708280  | 5700698   | 240.000                   |
| 1.500 x 1.875   | 5707654  | 5704272   | 240.000                   |
| 1.500 x 2.000   | 8115-448-056   | -   | 288.000                   |
| 2.000 x .500  | 8120-448-011   | 8120-448-006  | 288.000                   |
| 2.000 x 1.000   | 8120-448-021   | 8120-448-019  | 288.000                   |

### Step 3 - Verify life requirement of ball nut and end support

- Calculate life of ball screw assembly using  $L_{10} = (C_{am} / \text{Load})^3$  million inches
  - Calculate life of end supports using  $L_{10} = (C_{am} / \text{Load per support})^3$  million revolutions
- i.e. : Divide load by 2 if using 2 BK-BK, FK-FK, MK-BK, or WK-WK.*

**Table 3 - Component Dynamic Capacity**

|  Dia. x Lead |  Standard Nut $C_{am}$ (lb) |  Preload Nut $C_{am}$ (lb) |  BK Support $C_{am}$ (lb) |  FK / MK Support $C_{am}$ (lb) |  WK Support $C_{am}$ (lb) |
|---|--|---|--|---|--|
| .500 x .200   | 1,200  | 1,200   | 430  | 430   | -  |
| .500 x .500   | 929  | -   | 430  | 430   | -  |
| .631 x .200   | 800  | 800   | 478  | 478   | -  |
| .631 x 1.000  | 578  | 578   | 478  | 478   | -  |
| .750 x .200   | 950  | 950   | 529  | 529   | -  |
| .750 x .500   | 3,450  | 3,450   | 529  | 529   | -  |
| .875 x .200   | 1,942  | -   | 910  | 910   | 5,980  |
| 1.000 x .250  | 1,612  | 1,612   | 1,656  | 2,270   | 5,980  |
| 1.000 x .500  | 3,950  | 3,950   | 1,656  | 2,270   | 5,980  |
| 1.000 x 1.000   | 2,400  | -   | 1,656  | 2,270   | 5,980  |
| 1.150 x .200  | 2,400  | 2,400   | 2,742  | 2,742   | 9,105  |
| 1.500 x .250  | 4,198  | 4,198   | 3,632  | 3,632   | 9,667  |
| 1.500 x .473  | 10,050   | -   | 3,632  | 3,632   | 9,667  |
| 1.500 x .500  | 14,513   | 14,513  | 3,632  | 3,632   | 9,667  |
| 1.500 x 1.000   | 8,250  | 8,250   | 3,632  | 3,632   | 9,667  |
| 1.500 x 1.875   | 7,242  | 7,242   | 3,632  | 3,632   | 9,667  |
| 1.500 x 2.000   | 7,600  | -   | 3,632  | 3,632   | 9,667  |
| 2.000 x .500  | 18,500   | 18,500  | 7,093  | -   | 11,691   |
| 2.000 x 1.000   | 21,200   | 21,200  | 7,093  | -   | 11,691   |

**Step 4 - Verify screw meets critical speed limitation**

- Acceptable length / speed combinations are below and left of the selected curve (screw diameter)

**Figure 1 - Critical Speed Graph**

**Speed vs Length (Inch Series)  
BK -BF, FK-FF, MK-BF**

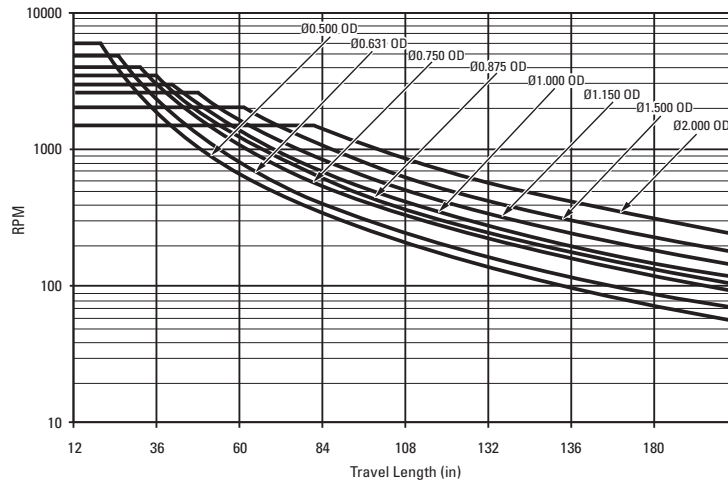

**Speed vs Length (Inch Series)  
BK-BK, FK-FK, MK-BK, WK-WK**

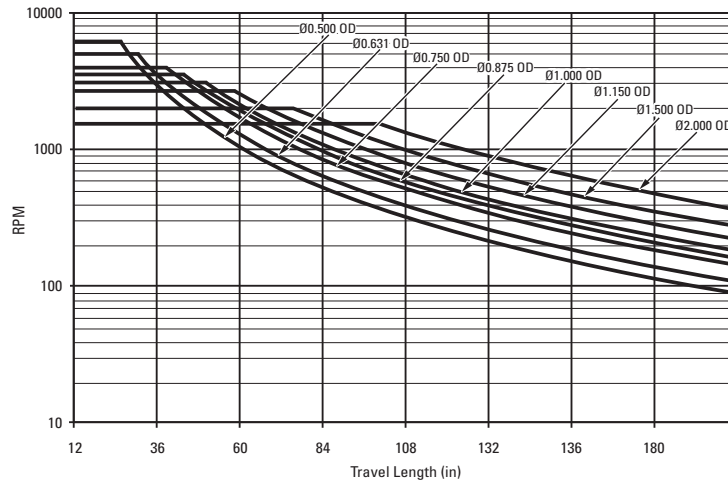

**Step 5 - Build Quick-Install Engineered Ball Screw Part Number - Inch Series Example**

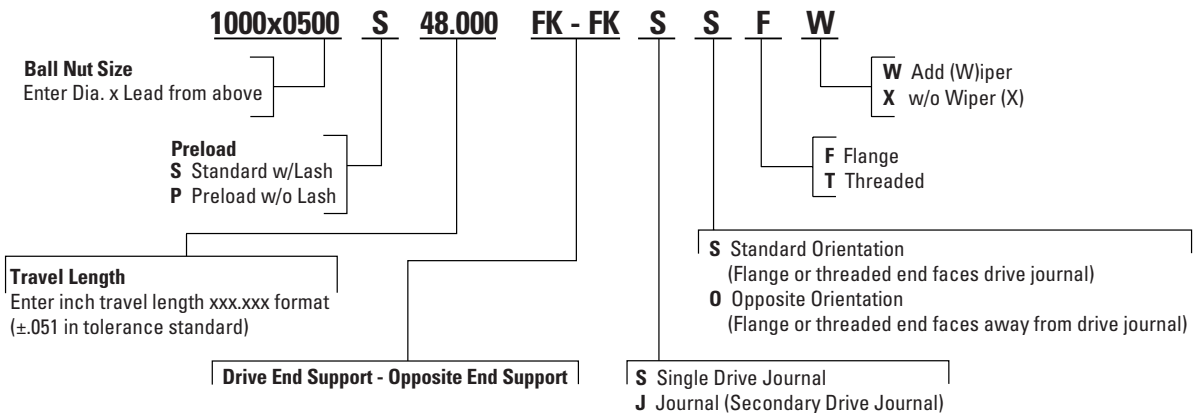

**Step 6 - Contact Thomson Customer Support (Call 540-633-3549) or thomson@thomsonlinear.com or your local Thomson Distributor to order**

## How to Select an Metric Series Ball Screw Assembly

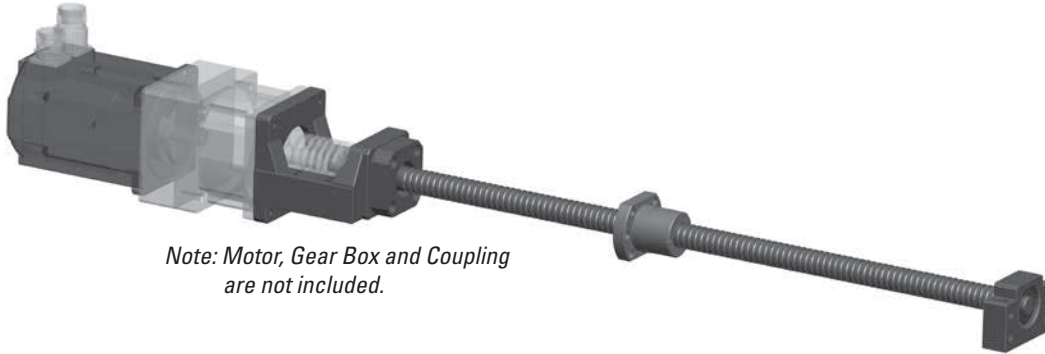

Note: Motor, Gear Box and Coupling are not included.

### Step 1 - Select system based on load capacity and mounting configuration

- Table below indicates maximum axial load that selected ball nut diameter and end configuration can support
- Select a ball screw diameter / end support configuration with a load capacity exceeding application requirement

**Table 1 - End Support Axial Load Capacity (N)**

| Ball Screw Dia. | BK - BK | BK - BF | FK - FK | FK - FF | MK - BK | MK - BF | WK - WK |
|-----------------|---------|---------|---------|---------|---------|---------|---------|
| 12mm            | 3,824   | 1,912   | 3,824   | 1,912   | 3,824   | 1,912   | -       |
| 16mm            | 4,256   | 2,128   | 4,256   | 2,128   | 4,256   | 2,128   | -       |
| 20mm            | 4,707   | 2,353   | 4,707   | 2,353   | 4,707   | 2,353   | -       |
| 25mm            | 8,394   | 4,197   | 11,512  | 5,756   | 9,953   | 5,756   | 43,931  |
| 32mm            | 13,905  | 6,952   | 13,905  | 6,952   | -       | -       | 57,071  |
| 40mm            | 18,416  | 9,208   | 18,416  | 9,208   | -       | -       | 58,444  |
| 50mm            | 35,969  | 17,984  | -       | -       | -       | -       | 63,739  |

### Step 2 - Select lead

- Select preload if zero lash is required
- Select lead based on required speed
- Linear speed (in/min) = (RPM) x (Lead)

**Table 2 - Ball Nut Part Number**

| Dia. x Lead | Flanged Nut Part Number | Cylindrical Nut Part Number | Threaded Nut Part Number | Maximum Screw Length (mm) |
|-------------|-------------------------|-----------------------------|--------------------------|---------------------------|
| 12 x 5      | -                       | KGM-N-1205-RH-00            | -                        | 1,500                     |
| 16 x 5      | KGF-D-1605-RH-EE        | KGM-D-1605-RH-EE            | 7832778                  | 6,000                     |
| 16 x 10     | KGF-D-1610-RH-EE        | KGM-D-1610-RH-EE            | -                        | 6,000                     |
| 20 x 5      | KGF-D-2005-RH-EE        | KGM-D-2005-RH-EE            | 7832781                  | 6,000                     |
| 25 x 5      | KGF-D-2505-RH-EE        | KGM-D-2505-RH-EE            | 7832788                  | 6,000                     |
| 25 x 10     | KGF-D-2510-RH-EE        | KGM-D-2510-RH-EE            | 7832792                  | 6,000                     |
| 25 x 20     | KGF-D-2520-RH-EE        | KGM-D-2520-RH-EE            | -                        | 6,000                     |
| 25 x 25     | KGF-D-2525-RH-EE        | KGM-D-2525-RH-EE            | -                        | 6,000                     |
| 25 x 50     | KGF-D-2550-RH-EE        | KGM-D-2550-RH-EE            | -                        | 6,000                     |
| 32 x 5      | KGF-D-3205-RH-EE        | KGM-D-3205-RH-EE            | 7832797                  | 6,000                     |
| 32 x 10     | KGF-D-3210-RH-EE        | KGM-D-3210-RH-EE            | -                        | 6,000                     |
| 32 x 20     | KGF-D-3220-RH-EE        | KGM-D-3220-RH-EE            | -                        | 6,000                     |
| 32 x 32     | KGF-D-3232-RH-EE        | -                           | -                        | 6,000                     |
| 32 X 40     | KGF-N-3240-RH-EE        | KGM-N-3240-RH-EE            | -                        | 6,000                     |
| 40 x 5      | KGF-D-4005-RH-EE        | KGM-D-4005-RH-EE            | 7832806                  | 6,000                     |
| 40 x 10     | KGF-D-4010-RH-EE        | KGM-D-4010-RH-EE            | 7832810                  | 6,000                     |
| 40 x 20     | KGF-D-4020-RH-EE        | KGM-D-4020-RH-EE            | -                        | 6,000                     |
| 40 x 40     | KGF-D-4040-RH-EE        | KGM-D-4040-RH-EE            | -                        | 6,000                     |
| 50 x 10     | KGF-D-5010-RH-EE        | KGM-N-5010-RH-EE            | 7832819                  | 6,000                     |
| 50 x 20     | KGF-D-5020-RH-EE        | KGM-N-5020-RH-EE            | -                        | 6,000                     |

### Step 3 - Verify life requirement of ball nut and end support

- Calculate life of ball screw assembly using  $L_{10} = (C_{am} / \text{Load})^3$  million revolutions
  - Calculate life of end supports using  $L_{10} = (C_{am} / \text{Load per support})^3$  million revolutions
- i.e. : Divide load by 2 if using 2 BK-BK, FK-FK, MK-BK, or WK-WK.*

**Table 3 - Component Dynamic Capacity**

| Dia. x Lead | Flanged Nut $C_{am}$ (kN) | Cylindrical Nut $C_{am}$ (kN) | Threaded Nut $C_{am}$ (kN) | BK Support $C_{am}$ (kN) | FK / MK Support $C_{am}$ (kN) | WK Support $C_{am}$ (kN) |
|-------------|---------------------------|-------------------------------|----------------------------|--------------------------|-------------------------------|--------------------------|
| 12 x 5      | -                         | 4.4                           | -                          | 1.9                      | 1.9                           | -                        |
| 16 x 5      | 9.3                       | 9.3                           | 12.1                       | 2.1                      | 2.1                           | -                        |
| 16 x 10     | 15.4                      | 15.4                          | -                          | 2.1                      | 2.1                           | -                        |
| 20 x 5      | 10.5                      | 10.5                          | 14.8                       | 2.4                      | 2.4                           | -                        |
| 25 x 5      | 12.3                      | 12.3                          | 20.4                       | 4.2                      | 10.2                          | 26.6                     |
| 25 x 10     | 13.2                      | 13.2                          | 19.9                       | 4.2                      | 10.2                          | 26.6                     |
| 25 x 20     | 13.0                      | 13.0                          | -                          | 4.2                      | 10.2                          | 26.6                     |
| 25 x 25     | 16.7                      | 16.7                          | -                          | 4.2                      | 10.2                          | 26.6                     |
| 25 x 50     | 15.4                      | 15.4                          | -                          | 4.2                      | 10.2                          | 26.6                     |
| 32 x 5      | 21.5                      | 21.5                          | 23.3                       | 7.0                      | 12.3                          | 40.5                     |
| 32 x 10     | 33.4                      | 33.4                          | -                          | 7.0                      | 12.3                          | 40.5                     |
| 32 x 20     | 29.7                      | 29.7                          | -                          | 7.0                      | 12.3                          | 40.5                     |
| 32 x 32     | 18.0                      | -                             | -                          | 7.0                      | 12.3                          | 40.5                     |
| 32 X 40     | 14.9                      | 14.9                          | -                          | 7.0                      | 12.3                          | 40.5                     |
| 40 x 5      | 23.8                      | 23.8                          | 26.3                       | 9.2                      | 16.1                          | 43.0                     |
| 40 x 10     | 38.0                      | 38.0                          | 78.6                       | 9.2                      | 16.1                          | 43.0                     |
| 40 x 20     | 33.3                      | 33.3                          | -                          | 9.2                      | 16.1                          | 43.0                     |
| 40 x 40     | 35.0                      | 35.0                          | -                          | 9.2                      | 16.1                          | 43.0                     |
| 50 x 10     | 68.7                      | 68.7                          | 97.8                       | 18.0                     | -                             | 52.0                     |
| 50 x 20     | 60.0                      | 60.0                          | -                          | 18.0                     | -                             | 52.0                     |

**Step 4 - Verify screw meets critical speed limitation**

- Acceptable length / speed combinations are below and left of the selected curve (screw diameter)

**Figure 1 - Critical Speed Graph**

**Speed vs Length (Metric Series)  
BF-FF, MK-BF, FK-BK**

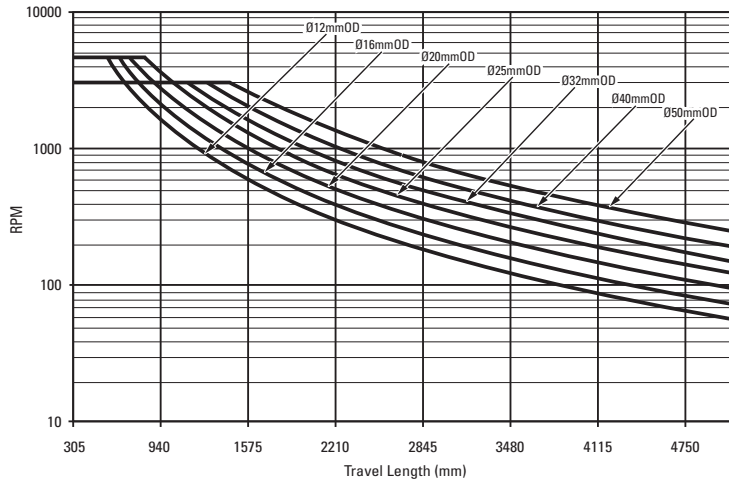

**Speed vs Length (Metric Series)  
BK-BK, FK-FK, MK-BK, WK-WK**

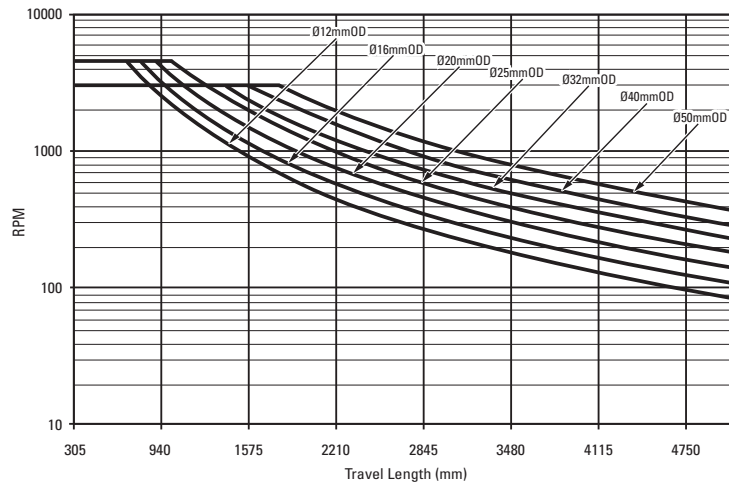

**Step 5 - Build Quick-Install Engineered Ball Screw Part Number - Metric Series Example**

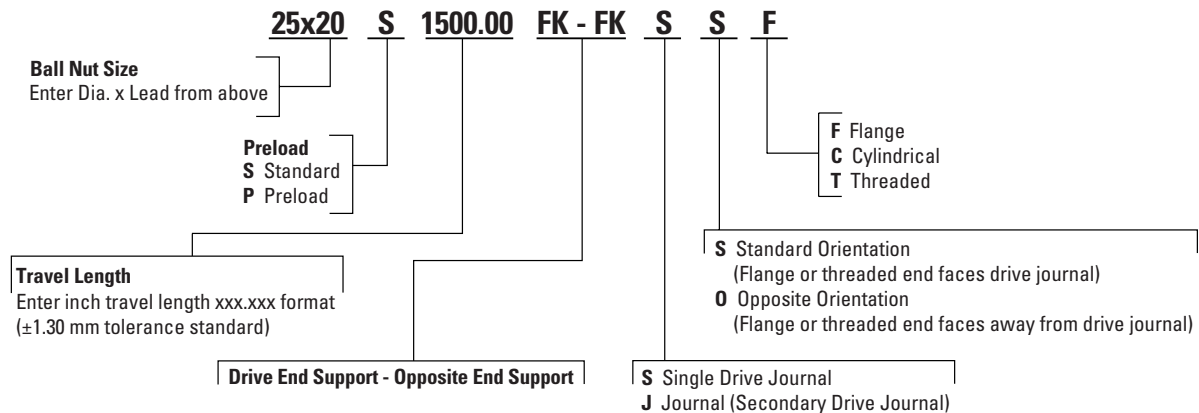









**Step 6 - Contact Thomson Customer Support (Call 540-633-3549) or [thomson@thomsonlinear.com](mailto:thomson@thomsonlinear.com) or your local Thomson Distributor to order**

# How to Install a Ball Screw Assembly

## Step 1 - Determine Extended Ball Nut Length







- Determine the overall length of the ball nut including accessories
- Extended Ball Nut Length = Ball Nut Length + Flange Adder + Wiper Adder

|  Dia x Lead |  Standard Nut P/N | Standard Ball Nut Length (in) |  Preload Nut P/N | Preload Ball Nut Length (in) |  Flange Adder (in) |  Wiper Adder (in) |
|--|--|-------------------------------|---|------------------------------|---|--|
| .500 x .200  | 8105-448-013   | 2.750                         | 8105-448-008  | 5.950                        | 0.150   | 0.287  |
| .500 x .500  | 8105-448-014   | 1.750                         | -   | -                            | 0.150   | 0.287  |
| .631 x .200  | 8106-448-022   | 1.710                         | 8106-448-012  | 3.875                        | 0.030   | -  |
| .631 x 1.000   | 7826713  | 1.710                         | 7827531   | 3.440                        | 0.030   | 0.287  |
| .750 x .200  | 8107-448-018   | 1.880                         | 8107-448-025  | 4.080                        | 0.030   | 0.306  |
| .750 x .500  | 8107-448-014   | 2.930                         | 8107-448-011  | 6.180                        | 0.030   | 0.306  |
| .875 x .200  | 5708277  | 2.704                         | -   | -                            | 0.020   | 0.242  |
| 1.000 x .250   | 8110-448-055   | 2.347                         | 5704167   | 4.847                        | 0.030   | - / 0.344  |
| 1.000 x .500   | 8110-448-022   | 3.120                         | 8110-448-016  | 6.640                        | 0.005   | 0.306  |
| 1.000 x 1.000  | 8110-448-086   | 3.000                         | -   | -                            | 0.030   | -  |
| 1.150 x .200   | 8111-448-006   | 2.500                         | 8111-448-004  | 5.500                        | 0.015   | 0.306  |
| 1.500 x .250   | 7833233  | 2.875                         | 7833234   | 6.375                        | 0.020   | 0.287  |
| 1.500 x .473   | 5707513  | 4.312                         | -   | -                            | 0.020   | 0.287  |
| 1.500 x .500   | 8115-448-016   | 5.565                         | 8115-448-006  | 12.100                       | 0.030   | -  |
| 1.500 x 1.000  | 5708280  | 3.628                         | 5700698   | 7.628                        | 0.020   | 0.328  |
| 1.500 x 1.875  | 5707654  | 5.000                         | 5704272   | 10.625                       | 0.020   | 0.328  |
| 1.500 x 2.000  | 8115-448-056   | 5.250                         | -   | -                            | 0.020   | -  |
| 2.000 x .500   | 8120-448-011   | 6.380                         | 8120-448-006  | 13.920                       | 0.031   | -  |
| 2.000 x 1.000  | 8120-448-021   | 6.380                         | 8120-448-019  | 13.900                       | 0.031   | -  |

|  Dia x Lead |  Flanged Nut P/N | Ball Nut Length (in) |  Cylindrical Nut P/N | Ball Nut Length (in) |  Threaded Nut P/N | Ball Nut Length (in) |
|---|---|----------------------|---|----------------------|--|----------------------|
| 12 x 5  | -   | -                    | KGM-N-1205-RH-00  | 0.945                | -  | -                    |
| 16 x 5  | KGF-D-1605-RH-EE  | 1.654                | KGM-D-1605-RH-EE  | 1.339                | 7832778  | 2.264                |
| 16 x 10   | KGF-D-1610-RH-EE  | 2.165                | KGM-D-1610-RH-EE  | 1.969                | -  | -                    |
| 20 x 5  | KGF-D-2005-RH-EE  | 1.654                | KGM-D-2005-RH-EE  | 1.339                | 7832781  | 2.264                |
| 25 x 5  | KGF-D-2505-RH-EE  | 1.654                | KGM-D-2505-RH-EE  | 1.339                | 7832788  | 2.500                |
| 25 x 10   | KGF-D-2510-RH-EE  | 2.165                | KGM-D-2510-RH-EE  | 1.772                | 7832792  | 2.402                |
| 25 x 20   | KGF-D-2520-RH-EE  | 1.378                | KGM-D-2520-RH-EE  | 1.378                | -  | -                    |
| 25 x 25   | KGF-D-2525-RH-EE  | 1.378                | KGM-D-2525-RH-EE  | 1.378                | -  | -                    |
| 25 x 50   | KGF-D-2550-RH-EE  | 2.283                | KGM-D-2550-RH-EE  | 2.283                | -  | -                    |
| 32 x 5  | KGF-D-3205-RH-EE  | 2.165                | KGM-D-3205-RH-EE  | 1.772                | 7832797  | 2.579                |
| 32 x 10   | KGF-D-3210-RH-EE  | 2.717                | KGM-N-3210-RH-EE  | 2.362                | -  | -                    |
| 32 x 20   | KGF-D-3220-RH-EE  | 3.150                | KGM-N-3220-RH-EE  | 2.756                | -  | -                    |
| 32 x 32   | KGF-D-3232-RH-EE  | 1.654                | -   | -                    | -  | -                    |
| 32 X 40   | KGF-N-3240-RH-EE  | 1.772                | KGM-N-3240-RH-EE  | 1.772                | -  | -                    |
| 40 x 5  | KGF-D-4005-RH-EE  | 2.244                | KGM-D-4005-RH-EE  | 1.772                | 7832806  | 2.657                |
| 40 x 10   | KGF-D-4010-RH-EE  | 2.795                | KGM-D-4010-RH-EE  | 2.362                | 7832810  | 4.154                |
| 40 x 20   | KGF-D-4020-RH-EE  | 3.150                | KGM-D-4020-RH-EE  | 2.756                | -  | -                    |
| 40 x 40   | KGF-D-4040-RH-EE  | 3.346                | KGM-D-4040-RH-EE  | 3.346                | -  | -                    |
| 50 x 10   | KGF-D-5010-RH-EE  | 3.740                | KGM-N-5010-RH-EE  | 3.228                | 7832819  | 4.646                |
| 50 x 20   | KGF-D-5020-RH-EE  | 3.740                | KGM-N-5020-RH-EE  | 3.228                | -  | -                    |

## Step 2 - Determine Screw Length

- Determine overall length of ball screw (OAL)
- OAL = Travel + Extended Ball Nut Length + End Support Configuration (Table Below)

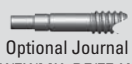
| Ball Nut Dia                    |  BK - BK |  BK - BF |  FK - FK |  FK - FF |  MK - BK |  MK - BF |  WK - WK |  Optional Journal BK/FK/MK, BF/FF, WK |
|---------------------------------|---|---|---|---|---|---|---|--|
| 0.500 in / 12mm                 | 3.425   | 2.658   | 3.425   | 2.500   | 3.425   | 2.658   | -   | 0.591 / 0.591 / -  |
| 0.631 in / 16mm                 | 3.425   | 2.677   | 3.425   | 2.579   | 3.425   | 2.677   | -   | 0.591 / 0.591 / -  |
| 0.750 in / 20mm                 | 3.937   | 3.091   | 4.488   | 3.307   | 4.213   | 3.367   | -   | 0.787 / 0.787 / -  |
| 0.875 in                        | 5.079   | 3.839   | 5.472   | 3.976   | -   | -   | 7.717   | 0.905 / 0.905 / 1.339  |
| 1.000 in / 25mm                 | 5.158   | 3.977   | 5.866   | 4.291   | 5.512   | 4.331   | 7.717   | 0.984 / 0.866 / 1.339  |
| 1.150 in / 32mm                 | 6.299   | 4.822   | 7.165   | 5.137   | 6.732   | 5.255   | 8.543   | 1.181 / 1.181 / 1.535  |
| 1.500 x .473 & 1.000 in         | 6.299   | 4.822   | 7.165   | 5.137   | 6.732   | 5.255   | 8.543   | 1.181 / 1.181 / 1.535  |
| 1.500 x .200, .250, .500 in     | 7.166   | 5.473   | 7.166   | 5.375   | 7.166   | 5.473   | 8.819   | 1.496 / 1.496 / 1.811  |
| 1.500 x 1.875 & 2.000 in / 40mm | 7.166   | 5.473   | 7.166   | 5.375   | 7.166   | 5.473   | 8.819   | 1.496 / 1.496 / 1.811  |
| 2.000 in / 50mm                 | 9.291   | 6.910   | -   | -   | -   | -   | 9.409   | 1.969 / 1.969 / 2.165  |



### Step 3 - Determine Mounting Pattern

- Table below indicates mounting interface ("A" = Travel Length + Nut Length)

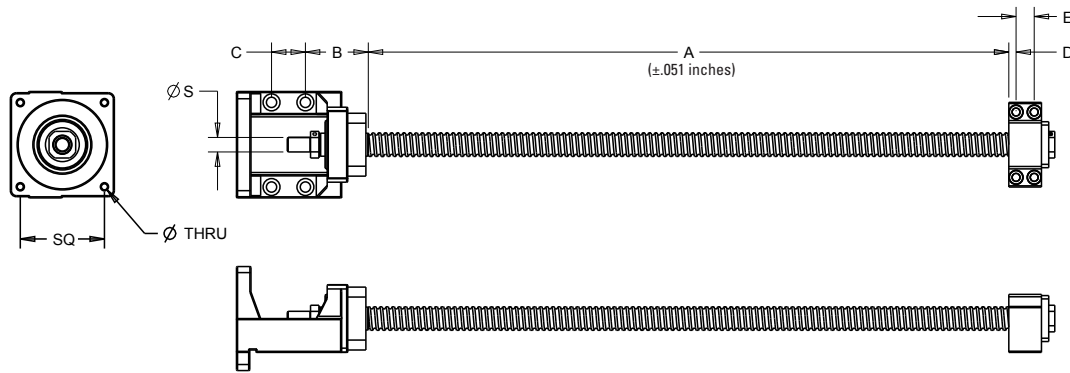

| Ball Nut Dia                    | BK - BK                     | BK - BF                 | MK - BK                     | MK - BF                  | MK              |                            |             | ALL                  |
|---------------------------------|-----------------------------|-------------------------|-----------------------------|--------------------------|-----------------|----------------------------|-------------|----------------------|
|                                 |                             |                         |                             |                          | Motor Interface | Mounting Pattern "SQ" (in) | "THRU" Hole | Drive Shaft "S" (in) |
|                                 | B/C/D/E (±.005 in)          | B/C/D/E (±.005 in)      | B/C/D/E (±.005 in)          | B/C/D/E (±.005 in)       |                 |                            |             |                      |
| 0.500 in / 12mm                 | .256 / .512 / .256 / .512   | .256 / .512 / .394 / -  | 1.339 / .787 / .256 / .512  | 1.339 / .787 / .394 / -  | NEMA 23         | 1.856                      | M4 x .7     | .3150 / .3144        |
| 0.631 in / 16mm                 | .256 / .512 / .256 / .512   | .256 / .512 / .394 / -  | 1.339 / .787 / .256 / .512  | 1.339 / .787 / .394 / -  | NEMA 23         | 1.856                      | M4 x .7     | .3937 / .3931        |
| 0.750 in 20mm                   | .236 / .591 / .236 / .591   | .236 / .591 / .394 / -  | 1.536 / 1.102 / .236 / .591 | 1.536 / 1.102 / .394 / - | NEMA 23         | 1.856                      | M4 x .7     | .4724 / .4717        |
| 0.875 in                        | .315 / .748 / .315 / .748   | .315 / .748 / .453 / -  | -                           | -                        | -               | -                          | -           | .5906 / .5898        |
| 1.000 in / 25mm                 | .315 / .748 / .315 / .748   | .315 / .748 / .512 / -  | 2.008 / 1.654 / .315 / .748 | 2.008 / 1.654 / .512 / - | NEMA 34         | 2.740                      | M6 x 1.0    | .6693 / .6686        |
| 1.150 in / 32mm                 | .394 / .866 / .394 / .866   | .394 / .866 / .591 / -  | -                           | -                        | -               | -                          | -           | .7874 / .7866        |
| 1.500 x .473 & 1.000 in         | .394 / .866 / .394 / .866   | .394 / .866 / .591 / -  | -                           | -                        | -               | -                          | -           | .7874 / .7866        |
| 1.500 x .200, .250, .500 in     | .433 / .906 / .433 / .906   | .433 / .906 / .630 / -  | -                           | -                        | -               | -                          | -           | .9843 / .9834        |
| 1.500 x 1.875 & 2.000 in / 40mm | .433 / .906 / .433 / .906   | .433 / .906 / .630 / -  | -                           | -                        | -               | -                          | -           | .9843 / .9834        |
| 2.000 in / 50mm                 | .551 / 1.299 / .551 / 1.299 | .551 / 1.299 / .728 / - | -                           | -                        | -               | -                          | -           | 1.3780 / 1.3771      |

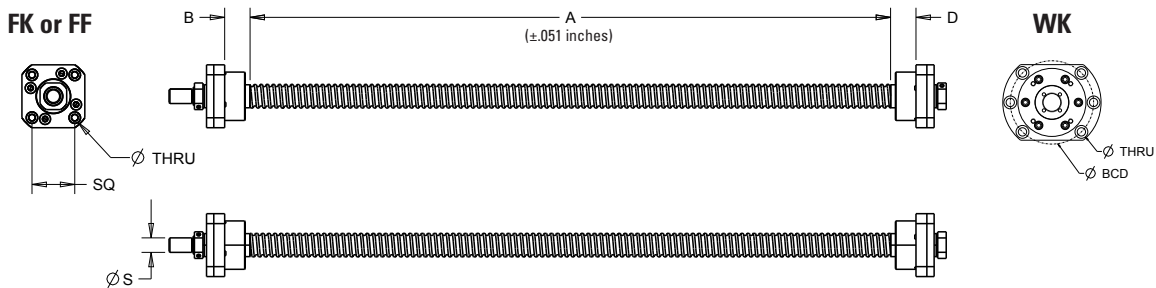

| Ball Nut Dia                    | FK - FK        | FK - FF        | FK / FF                    |  | WK - WK        |                             |   | ALL                  |
|---------------------------------|----------------|----------------|----------------------------|--|----------------|-----------------------------|---|----------------------|
|                                 |                |                | Mounting Pattern "SQ" (in) | "THRU" Hole Clearance & C'bore for given screw |                | Mounting Pattern "BCD" (in) | "THRU" Hole (in) Clearance & C'bore for given screw | Drive Shaft "S" (in) |
|                                 | B/D (±.005 in) | B/D (±.005 in) |                            |  | B/D (±.005 in) |                             |   |                      |
| 0.500 in / 12mm                 | 0.689 / .689   | .669 / .196    | 1.170 / 0.974              | M4 / M3  | -              | -                           | -   | .3150 / .3144        |
| 0.631 in / 16mm                 | 0.689 / .689   | .669 / .315    | 1.225 / 1.170              | M4 / M4  | -              | -                           | -   | .3937 / .3931        |
| 0.750 in 20mm                   | 0.827 / .827   | .827 / .315    | 1.392 / 1.392              | M5 / M5  | -              | -                           | -   | .4724 / .4717        |
| 0.875 in                        | 0.945 / .945   | .945 / .354    | 1.726 / 1.726              | M6 / M6  | 1.260 / 1.260  | 3.465                       | M8  | .5906 / .5898        |
| 1.000 in / 25mm                 | 1.220 / 1.220  | 1.220 / .354   | 1.949 / 1.949              | M6 / M6  | 1.260 / 1.260  | 3.465                       | M8  | .6693 / .6686        |
| 1.150 in / 32mm                 | 1.378 / 1.378  | 1.378 / .394   | 2.228 / 2.228              | M8 / M8  | 1.300 / 1.300  | 4.331                       | M10   | .7874 / .7866        |
| 1.500 x .473 & 1.000 in         | 1.378 / 1.378  | 1.378 / .394   | 2.228 / 2.228              | M8 / M8  | 1.300 / 1.300  | 4.331                       | M10   | .7874 / .7866        |
| 1.500 x .200, .250, .500 in     | 1.142 / 1.142  | 1.142 / .354   | 2.645 / 2.645              | M10 / M10                                      | 1.300 / 1.300  | 4.331                       | M10   | .9843 / .9834        |
| 1.500 x 1.875 & 2.000 in / 40mm | 1.142 / 1.142  | 1.142 / .354   | 2.645 / 2.645              | M10 / M10                                      | 1.300 / 1.300  | 4.331                       | M10   | .9843 / .9834        |
| 2.000 in / 50mm                 | -              | -              | -                          | -  | 1.300 / 1.300  | 4.764                       | M10   | 1.3780 / 1.3771      |

## Bearing Supports/End Machining — Ball Screws

BK

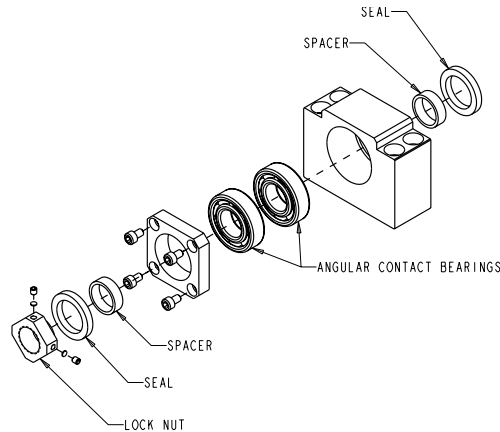

### Bearing Supports / End Machining - Inch Series Ball Screw

BK Bearing Supports

| Standard P/N | Dia. X Lead (inch)   | Bearing Rating      |       |       |                         |       |       | Lock Nut Type | Block Weight (lbs) |
|--------------|--|---------------------|-------|-------|-------------------------|-------|-------|---------------|--------------------|
|              |  | Static Rating $C_0$ |       |       | Dynamic Rating $C_{am}$ |       |       |               |                    |
|              |  | (kgf)               | (lbs) | (N)   | (kgf)                   | (lbs) | (N)   |               |                    |
| 7833360      | 0.5  | 530                 | 1168  | 5197  | 195                     | 430   | 1912  | RN10          | 0.9                |
| 7833361      | 0.631  | 610                 | 1345  | 5982  | 217                     | 478   | 2128  | RN12          | 1.0                |
| 7833362      | 0.75   | 700                 | 1543  | 6864  | 240                     | 529   | 2353  | RN15          | 1.3                |
| 7833363      | 0.875  | 1220                | 2690  | 11963 | 413                     | 910   | 4050  | RN17          | 2.9                |
| 7833364      | 1.000 / 1.171  | 1340                | 2954  | 13140 | 428                     | 944   | 4197  | RN20          | 2.8                |
| 7833365      | 1.150 / 1.250  | 2090                | 4608  | 20495 | 709                     | 1563  | 6952  | RN25          | 5.3                |
| 7833366      | 1.500 x 0.473 & 1.000<br>1.500 x 0.200 & 0.250<br>1.500 x 0.500 & 1.875<br>1.500 x 2.000 | 3000                | 6614  | 29418 | 939                     | 2070  | 9208  | RN30          | 7.5                |
| 7833367      | 1.750 / 2.000  | 4700                | 10362 | 46088 | 1834                    | 4043  | 17984 | RN40          | 15.0               |

### Bearing Supports / End Machining - Metric Series Ball Screw

BK Bearing Supports

| Standard P/N | Dia. X Lead (mm) | Bearing Rating      |       |       |                         |       |       | Lock Nut Type | Block Weight (kg) |
|--------------|------------------|---------------------|-------|-------|-------------------------|-------|-------|---------------|-------------------|
|              |                  | Static Rating $C_0$ |       |       | Dynamic Rating $C_{am}$ |       |       |               |                   |
|              |                  | (kgf)               | (lbs) | (N)   | (kgf)                   | (lbs) | (N)   |               |                   |
| 7833391      | 12               | 530                 | 1168  | 5197  | 195                     | 430   | 1912  | RN10          | 0.4               |
| 7833392      | 16               | 610                 | 1345  | 5982  | 217                     | 478   | 2128  | RN12          | 0.5               |
| 7833393      | 20               | 700                 | 1543  | 6864  | 240                     | 529   | 2353  | RN15          | 0.6               |
| 7833394      | 25               | 1340                | 2954  | 13140 | 428                     | 944   | 4197  | RN20          | 1.3               |
| 7833395      | 32               | 2090                | 4608  | 20495 | 709                     | 1563  | 6952  | RN25          | 2.4               |
| 7833396      | 40               | 3000                | 6614  | 29418 | 939                     | 2070  | 9208  | RN30          | 3.4               |
| 7833397      | 50               | 4700                | 10362 | 46088 | 1834                    | 4043  | 17984 | RN40          | 6.8               |

### Bearing Supports / End Machining - Ball Splines

BK Bearing Supports

| Standard P/N | Spline Size (inch) | Bearing Rating      |       |       |                         |       |       | Lock Nut Type | Block Weight (lbs) |
|--------------|--------------------|---------------------|-------|-------|-------------------------|-------|-------|---------------|--------------------|
|              |                    | Static Rating $C_0$ |       |       | Dynamic Rating $C_{am}$ |       |       |               |                    |
|              |                    | (kgf)               | (lbs) | (N)   | (kgf)                   | (lbs) | (N)   |               |                    |
| 7833360      | 0.625              | 530                 | 1168  | 5197  | 195                     | 430   | 1912  | RN10          | 0.9                |
| 7833364      | 1.000              | 1340                | 2954  | 13140 | 428                     | 944   | 4197  | RN20          | 2.8                |
| 7833365      | 1.500              | 2090                | 4608  | 20495 | 709                     | 1563  | 6952  | RN25          | 5.3                |
| 7833367      | 2.000              | 4700                | 10362 | 46088 | 1834                    | 4043  | 17984 | RN40          | 15.0               |

## Bearing Supports/End Machining — Ball Screws

BK

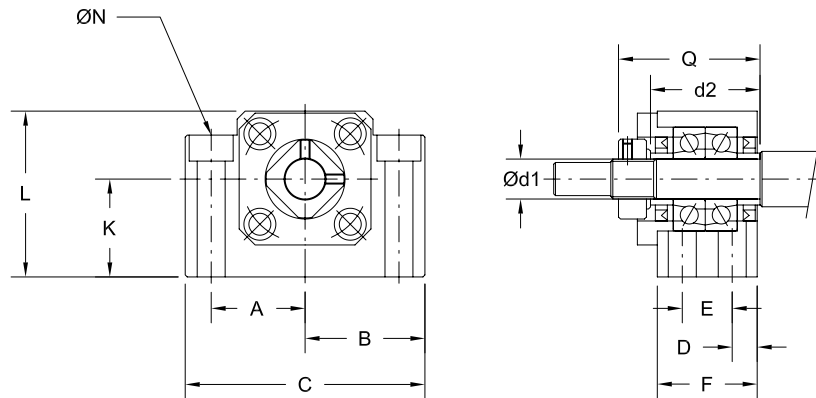

### Bearing Supports / End Machining - Inch Series Ball Screw

BK Bearing Supports

| Standard P/N | Bearing Block Dimensions (inch) |       |       |       |       |       |       |       |          |       |                                      |       |
|--------------|---------------------------------|-------|-------|-------|-------|-------|-------|-------|----------|-------|--------------------------------------|-------|
|              | d1 (mm)                         | d2    | A     | B     | C     | D     | E     | F     | K ±0.001 | L     | N                                    | Q     |
| 7833360      | 10                              | 1.063 | 0.906 | 1.181 | 2.362 | 0.236 | 0.512 | 0.984 | 0.866    | 1.535 | 4x .260 Thru, .425 C-Bore x .197 Dp  | 1.339 |
| 7833361      | 12                              | 1.063 | 0.906 | 1.181 | 2.362 | 0.236 | 0.512 | 0.984 | 0.984    | 1.693 | 4x .260 Thru, .425 C-Bore x .059 Dp  | 1.339 |
| 7833362      | 15                              | 1.181 | 1.063 | 1.378 | 2.756 | 0.236 | 0.591 | 1.063 | 1.102    | 1.890 | 4x .260 Thru, .433 C-Bore x .256 Dp  | 1.496 |
| 7833363      | 17                              | 1.496 | 1.339 | 1.693 | 3.386 | 0.315 | 0.748 | 1.378 | 1.535    | 2.520 | 4x .354 Thru, .551 C-Bore x .335 Dp  | 2.008 |
| 7833364      | 20                              | 1.575 | 1.378 | 1.732 | 3.465 | 0.315 | 0.748 | 1.378 | 1.339    | 2.362 | 4x .354 Thru, .551 C-Bore x .335 Dp  | 2.008 |
| 7833365      | 25                              | 1.890 | 1.673 | 2.087 | 4.173 | 0.394 | 0.866 | 1.654 | 1.890    | 3.150 | 4x .433 Thru, .699 C-Bore x .433 Dp  | 2.480 |
| 7833366      | 30                              | 1.969 | 2.008 | 2.520 | 5.039 | 0.433 | 0.906 | 1.772 | 2.008    | 3.504 | 4x .551 Thru, .787 C-Bore x .512 Dp  | 2.756 |
| 7833367      | 40                              | 2.598 | 2.559 | 3.150 | 6.299 | 0.551 | 1.299 | 2.402 | 2.362    | 4.331 | 4x .709 Thru, 1.024 C-Bore x .689 Dp | 3.583 |

### Bearing Supports / End Machining - Metric Series Ball Screw

BK Bearing Supports

| Standard P/N | Bearing Block Dimensions (mm) |      |      |      |       |      |      |      |         |       |                                     |      |
|--------------|-------------------------------|------|------|------|-------|------|------|------|---------|-------|-------------------------------------|------|
|              | d1 (mm)                       | d2   | A    | B    | C     | D    | E    | F    | K ±0.02 | L     | N                                   | Q    |
| 7833391      | 10                            | 27.0 | 23.0 | 30.0 | 60.0  | 6.0  | 13.0 | 25.0 | 22.00   | 39.0  | 4x 6.6 Thru, 10.8 C-Bore x 5.0 Dp   | 34.0 |
| 7833392      | 12                            | 27.0 | 23.0 | 30.0 | 60.0  | 6.0  | 13.0 | 25.0 | 25.00   | 43.0  | 4x 6.6 Thru, 10.8 C-Bore x 1.5 Dp   | 34.0 |
| 7833393      | 15                            | 30.0 | 27.0 | 35.0 | 70.0  | 6.0  | 15.0 | 27.0 | 28.00   | 48.0  | 4x 6.6 Thru, 11.0 C-Bore x 6.5 Dp   | 38.0 |
| 7833394      | 20                            | 40.0 | 35.0 | 44.0 | 88.0  | 8.0  | 19.0 | 35.0 | 34.00   | 60.0  | 4x 9.0 Thru, 14.0 C-Bore x 8.5 Dp   | 51.0 |
| 7833395      | 25                            | 48.0 | 42.5 | 53.0 | 106.0 | 10.0 | 22.0 | 42.0 | 48.00   | 80.0  | 4x 11.0 Thru, 17.0 C-Bore x 11.0 Dp | 63.0 |
| 7833396      | 30                            | 50.0 | 51.0 | 64.0 | 128.0 | 11.0 | 23.0 | 45.0 | 51.00   | 89.0  | 4x 14.0 Thru, 20.0 C-Bore x 13.0 Dp | 70.0 |
| 7833397      | 40                            | 66.0 | 65.0 | 80.0 | 160.0 | 14.0 | 33.0 | 61.0 | 60.00   | 110.0 | 4x 18.0 Thru, 26.0 C-Bore x 17.5 Dp | 91.0 |

### Bearing Supports / End Machining - Ball Splines

BK Bearing Supports

| Standard P/N | Bearing Block Dimensions (inch) |       |       |       |       |       |       |       |          |       |                                      |       |
|--------------|---------------------------------|-------|-------|-------|-------|-------|-------|-------|----------|-------|--------------------------------------|-------|
|              | d1 (mm)                         | d2    | A     | B     | C     | D     | E     | F     | K ±0.001 | L     | N                                    | Q     |
| 7833360      | 10                              | 1.063 | 0.906 | 1.181 | 2.362 | 0.236 | 0.512 | 0.984 | 0.866    | 1.535 | 4x .260 Thru, .425 C-Bore x .197 Dp  | 1.339 |
| 7833364      | 20                              | 1.575 | 1.378 | 1.732 | 3.465 | 0.315 | 0.748 | 1.378 | 1.339    | 2.362 | 4x .354 Thru, .551 C-Bore x .335 Dp  | 2.008 |
| 7833365      | 25                              | 1.890 | 1.673 | 2.087 | 4.173 | 0.394 | 0.866 | 1.654 | 1.890    | 3.150 | 4x .433 Thru, .699 C-Bore x .433 Dp  | 2.480 |
| 7833367      | 40                              | 2.598 | 2.559 | 3.150 | 6.299 | 0.551 | 1.299 | 2.402 | 2.362    | 4.331 | 4x .709 Thru, 1.024 C-Bore x .689 Dp | 3.583 |

## Bearing Supports/End Machining — Ball Screws

BF

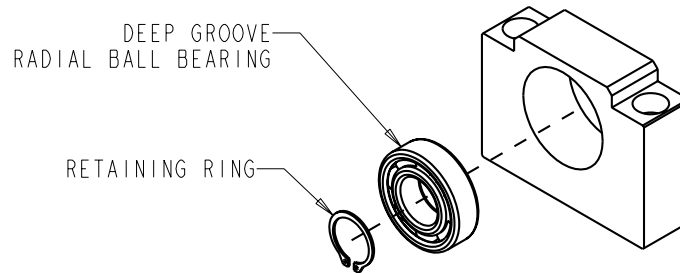

### Bearing Supports / End Machining - Inch Series Ball Screw

BF Bearing Supports

| Standard P/N | Dia. X Lead (inch)                             | *Snap Ring (mm) | Block Weight (lbs) |
|--------------|--|-----------------|--------------------|
| 7833368      | 0.5  | 8               | 0.7                |
| 7833369      | 0.631  | 10              | 0.8                |
| 7833370      | 0.75   | 15              | 0.9                |
| 7833371      | 0.875  | 17              | 1.7                |
| 7833372      | 1.000 / 1.171                                  | 20              | 1.7                |
| 7833373      | 1.150 / 1.250                                  | 25              | 3.2                |
|              | 1.500 x 0.473 & 1.000                          |                 |                    |
| 7833374      | 1.500 x 0.200 & 0.250<br>1.500 x 0.500 & 1.875 | 30              | 4.3                |
|              | 1.500 x 2.000                                  |                 |                    |
| 7833375      | 1.750 / 2.000                                  | 40              | 7.3                |

### Bearing Supports / End Machining - Metric Series Ball Screw

BF Bearing Supports

| Standard P/N | Dia. X Lead (mm) | *Snap Ring (mm) | Block Weight (kg) |
|--------------|------------------|-----------------|-------------------|
| 7833398      | 12               | 8               | 0.3               |
| 7833399      | 16               | 10              | 0.4               |
| 7833400      | 20               | 15              | 0.4               |
| 7833401      | 25               | 20              | 0.8               |
| 7833402      | 32               | 25              | 1.5               |
| 7833403      | 40               | 30              | 2.0               |
| 7833404      | 50               | 40              | 3.3               |

### Bearing Supports / End Machining - Ball Splines

BF Bearing Supports

| Standard P/N | Spline Size (inch) | *Snap Ring (mm) | Block Weight (lbs) |
|--------------|--------------------|-----------------|--------------------|
| 7833368      | 0.625              | 8               | 0.7                |
| 7833372      | 1.000              | 20              | 1.7                |
| 7833373      | 1.500              | 25              | 3.2                |
| 7833375      | 2.000              | 40              | 7.3                |

\*DIN 471

## Bearing Supports/End Machining — Ball Screws

BF

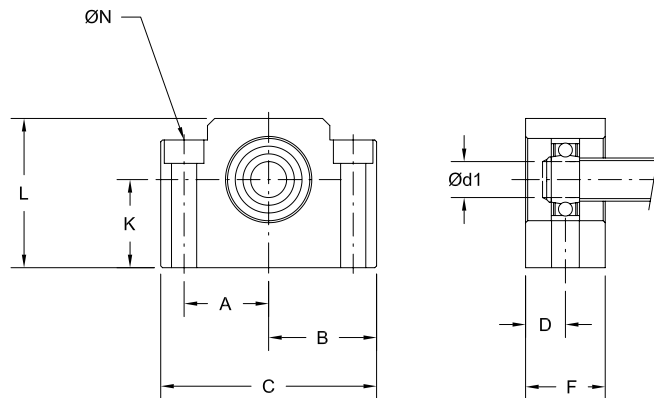

### Bearing Supports / End Machining - Inch Series Ball Screw

BF Bearing Supports

| Standard P/N | Bearing Block Dimensions (inch) |       |       |       |       |       |          |       |                                      |
|--------------|---------------------------------|-------|-------|-------|-------|-------|----------|-------|--------------------------------------|
|              | d1 (mm)                         | A     | B     | C     | D     | F     | K ±0.001 | L     | N                                    |
| 7833368      | 8                               | 0.906 | 1.181 | 2.362 | 0.394 | 0.787 | 0.866    | 1.535 | 2x .260 Thru, .425 C-Bore x .197 Dp  |
| 7833369      | 10                              | 0.906 | 1.181 | 2.362 | 0.394 | 0.787 | 0.984    | 1.693 | 2x .260 Thru, .425 C-Bore x .059 Dp  |
| 7833370      | 15                              | 2.244 | 1.378 | 2.756 | 0.394 | 0.787 | 1.102    | 1.890 | 2x .260 Thru, .433 C-Bore x .256 Dp  |
| 7833371      | 17                              | 1.339 | 1.693 | 3.386 | 0.453 | 0.906 | 1.535    | 2.520 | 2x .354 Thru, .551 C-Bore x .335 Dp  |
| 7833372      | 20                              | 1.378 | 1.732 | 3.465 | 0.512 | 1.024 | 1.339    | 2.362 | 2x .354 Thru, .551 C-Bore x .335 Dp  |
| 7833373      | 25                              | 1.673 | 2.087 | 4.173 | 0.591 | 1.181 | 1.890    | 3.150 | 2x .433 Thru, .699 C-Bore x .433 Dp  |
| 7833374      | 30                              | 2.008 | 2.520 | 5.039 | 0.630 | 1.260 | 2.008    | 3.504 | 2x .551 Thru, .787 C-Bore x .512 Dp  |
| 7833375      | 40                              | 2.559 | 3.150 | 6.299 | 0.728 | 1.457 | 2.362    | 4.331 | 2x .709 Thru, 1.024 C-Bore x .689 Dp |

### Bearing Supports / End Machining - Metric Series Ball Screw

BF Bearing Supports

| Standard P/N | Bearing Block Dimensions (mm) |      |      |       |      |      |         |       |                                     |
|--------------|-------------------------------|------|------|-------|------|------|---------|-------|-------------------------------------|
|              | d1 (mm)                       | A    | B    | C     | D    | F    | K ±0.02 | L     | N                                   |
| 7833398      | 8                             | 23.0 | 30.0 | 60.0  | 10.0 | 20.0 | 22.00   | 39.0  | 4x 6.6 Thru, 10.8 C-Bore x 5.0 Dp   |
| 7833399      | 10                            | 23.0 | 30.0 | 60.0  | 10.0 | 20.0 | 25.00   | 43.0  | 4x 6.6 Thru, 10.8 C-Bore x 1.5 Dp   |
| 7833400      | 15                            | 57.0 | 35.0 | 70.0  | 10.0 | 20.0 | 28.00   | 48.0  | 4x 6.6 Thru, 11.0 C-Bore x 6.5 Dp   |
| 7833401      | 20                            | 35.0 | 44.0 | 88.0  | 13.0 | 26.0 | 34.00   | 60.0  | 4x 9.0 Thru, 14.0 C-Bore x 8.5 Dp   |
| 7833402      | 25                            | 42.5 | 53.0 | 106.0 | 15.0 | 30.0 | 48.00   | 80.0  | 4x 11.0 Thru, 17.0 C-Bore x 11.0 Dp |
| 7833403      | 30                            | 51.0 | 64.0 | 128.0 | 16.0 | 32.0 | 51.00   | 89.0  | 4x 14.0 Thru, 20.0 C-Bore x 13.0 Dp |
| 7833404      | 40                            | 65.0 | 80.0 | 160.0 | 18.5 | 37.0 | 60.00   | 110.0 | 4x 18.0 Thru, 26.0 C-Bore x 17.5 Dp |

### Bearing Supports / End Machining - Ball Splines

BF Bearing Supports

| Standard P/N | Bearing Block Dimensions (inch) |       |       |       |       |       |          |       |                                      |
|--------------|---------------------------------|-------|-------|-------|-------|-------|----------|-------|--------------------------------------|
|              | d1 (mm)                         | A     | B     | C     | D     | F     | K ±0.001 | L     | N                                    |
| 7833368      | 8                               | 0.906 | 1.181 | 2.362 | 0.394 | 0.787 | 0.866    | 1.535 | 4x .260 Thru, .425 C-Bore x .197 Dp  |
| 7833372      | 20                              | 1.378 | 1.732 | 3.465 | 0.512 | 1.024 | 1.339    | 2.362 | 4x .354 Thru, .551 C-Bore x .335 Dp  |
| 7833373      | 25                              | 1.673 | 2.087 | 4.173 | 0.591 | 1.181 | 1.890    | 3.150 | 4x .433 Thru, .699 C-Bore x .433 Dp  |
| 7833375      | 40                              | 2.559 | 3.150 | 6.299 | 0.728 | 1.457 | 2.362    | 4.331 | 4x .709 Thru, 1.024 C-Bore x .689 Dp |

## Bearing Supports/End Machining — Ball Screws

BK

TYPE BK, REQUIRED FOR BK SUPPORT

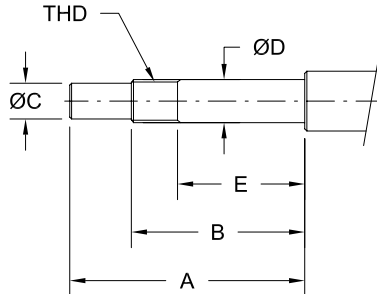

TYPE BK1, REQUIRED FOR BK SUPPORT

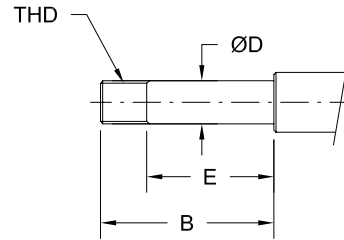

### Bearing Supports / End Machining - Inch Series Ball Screw

BK Standard End Machining

| Dia x Lead (inch)     | Standard P/N | Type BK / BK1 (inch) |       |               |               |       |         | Bearing Trade No. |
|-----------------------|--------------|----------------------|-------|---------------|---------------|-------|---------|-------------------|
|                       |              | A                    | B     | C             | D             | E     | THD     |                   |
| 0.500                 | 7833360      | 2.008                | 1.417 | .3150/.3144   | .3935/.3932   | 0.787 | M10x1   | 7000              |
| 0.631                 | 7833361      | 2.008                | 1.417 | .3937/.3931   | .4722/.4720   | 0.866 | M12x1   | 7001              |
| 0.750                 | 7833362      | 2.362                | 1.575 | .4724/.4717   | .5904/.5900   | 1.102 | M15x1   | 7002              |
| 0.875                 | 7833363      | 2.992                | 2.087 | .5906/.5898   | .6691/.6687   | 1.417 | M17x1   | 7203              |
| 1.000 / 1.171         | 7833364      | 3.071                | 2.087 | .6693/.6686   | .7872/.7869   | 1.496 | M20x1   | 7004              |
| 1.150 / 1.250         | 7833365      | 3.740                | 2.559 | .7874/.7866   | .9841/.9837   | 1.850 | M25x1.5 | 7205              |
| 1.500 x 0.473 & 1.000 | 7833366      | 4.331                | 2.835 | .9843/.9834   | 1.1809/1.1805 | 1.850 | M30x1.5 | 7206              |
| 1.500 x 0.200 & 0.250 |              |                      |       |               |               |       |         |                   |
| 1.500 x 0.500 & 1.875 |              |                      |       |               |               |       |         |                   |
| 1.500 x 2.000         | 7833367      | 5.630                | 3.661 | 1.3780/1.3771 | 1.5746/1.5742 | 2.283 | M40x1.5 | 7208              |
| 1.750 / 2.000         |              |                      |       |               |               |       |         |                   |

### Bearing Supports / End Machining - Metric Series Ball Screw

BK Standard End Machining

| Dia x Lead (mm) | Standard P/N | Type BK / BK1 (mm) |      |      |               |      |         | Bearing Trade No. |
|-----------------|--------------|--------------------|------|------|---------------|------|---------|-------------------|
|                 |              | A                  | B    | C    | D             | E    | THD     |                   |
| 12              | 7833391      | 51.0               | 36.0 | 8.0  | 9.995/9.988   | 20.0 | M10x1   | 7000              |
| 16              | 7833392      | 51.0               | 36.0 | 10.0 | 11.995/11.988 | 22.0 | M12x1   | 7001              |
| 20              | 7833393      | 60.0               | 40.0 | 12.0 | 14.995/14.986 | 28.0 | M15x1   | 7002              |
| 25              | 7833394      | 78.0               | 53.0 | 17.0 | 19.995/19.986 | 38.0 | M20x1   | 7004              |
| 32              | 7833395      | 95.0               | 65.0 | 20.0 | 24.995/24.985 | 47.0 | M25x1.5 | 7205              |
| 40              | 7833396      | 110.0              | 72.0 | 25.0 | 29.995/29.985 | 47.0 | M30x1.5 | 7206              |
| 50              | 7833397      | 143.0              | 93.0 | 35.0 | 39.995/39.985 | 58.0 | M40x1.5 | 7208              |

### Bearing Supports / End Machining - Ball Splines

BK Standard End Machining

| Spline Size (inch) | Standard P/N | Type BK / BK1 (inch) |       |               |               |       |         | Bearing Trade No. |
|--------------------|--------------|----------------------|-------|---------------|---------------|-------|---------|-------------------|
|                    |              | A                    | B     | C             | D             | E     | THD     |                   |
| 0.625              | 7833360      | 2.008                | 1.417 | .3150/.3144   | .3935/.3932   | 0.787 | M10x1   | 7000              |
| 1.000              | 7833364      | 3.071                | 2.087 | .6693/.6686   | .7872/.7869   | 1.496 | M20x1   | 7004              |
| 1.500              | 7833365      | 3.740                | 2.559 | .7874/.7866   | .9841/.9837   | 1.850 | M25x1.5 | 7205              |
| 2.000              | 7833367      | 5.630                | 3.661 | 1.3780/1.3771 | 1.5746/1.5742 | 2.283 | M40x1.5 | 7208              |

## Bearing Supports/End Machining — Ball Screws

BF

TYPE BF, REQUIRED FOR BF SUPPORT

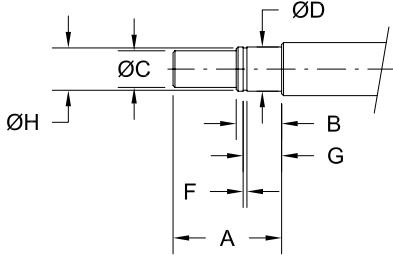

TYPE BF1, REQUIRED FOR BF SUPPORT

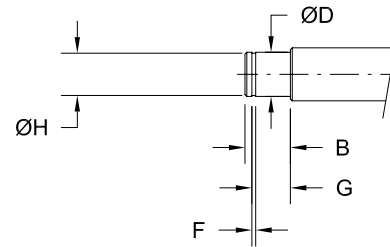

### Bearing Supports / End Machining - Inch Series Ball Screw

BF Standard End Machining

| Standard P/N | Type BF / BF1 (inch) |       |         |               |                    |                    |                    | *Snap Ring (mm) | Bearing Trade No. |
|--------------|----------------------|-------|---------|---------------|--------------------|--------------------|--------------------|-----------------|-------------------|
|              | A                    | B     | C<br>h7 | D             | F<br>+0.006/-0.000 | G<br>+0.008/-0.000 | H<br>+0.000/-0.008 |                 |                   |
| 7833368      | 0.984                | 0.394 | 0.236   | .3148/.3145   | 0.035              | 0.311              | 0.299              | 8               | 608               |
| 7833369      | 1.024                | 0.433 | 0.315   | .3935/.3932   | 0.045              | 0.360              | 0.378              | 10              | 6000              |
| 7833370      | 1.299                | 0.512 | 0.472   | .5904/.5900   | 0.045              | 0.400              | 0.563              | 15              | 6002              |
| 7833371      | 1.535                | 0.630 | 0.591   | .6691/.6687   | 0.045              | 0.518              | 0.638              | 17              | 6203              |
| 7833372      | 1.614                | 0.630 | 0.669   | .7872/.7869   | 0.053              | 0.526              | 0.748              | 20              | 6004              |
| 7833373      | 1.969                | 0.787 | 0.787   | .9841/.9837   | 0.053              | 0.644              | 0.941              | 25              | 6205              |
| 7833374      | 2.323                | 0.827 | 0.984   | 1.1809/1.1805 | 0.069              | 0.699              | 1.126              | 30              | 6206              |
| 7833375      | 2.974                | 0.906 | 1.378   | 1.5746/1.5742 | 0.077              | 0.785              | 1.496              | 40              | 6208              |

### Bearing Supports / End Machining - Metric Series Ball Screw

BF Standard End Machining

| Standard P/N | Type BF / BF1 (mm) |      |         |               |                    |                    |                    | *Snap Ring (mm) | Bearing Trade No. |
|--------------|--------------------|------|---------|---------------|--------------------|--------------------|--------------------|-----------------|-------------------|
|              | A                  | B    | C<br>h7 | D             | F<br>+0.140/-0.000 | G<br>+0.200/-0.000 | H<br>+0.000/-0.200 |                 |                   |
| 7833398      | 25.0               | 10.0 | 6.0     | 7.995/7.988   | 0.90               | 7.90               | 7.60               | 8               | 608               |
| 7833399      | 26.0               | 11.0 | 8.0     | 9.995/9.988   | 1.15               | 9.15               | 9.60               | 10              | 6000              |
| 7833400      | 33.0               | 13.0 | 12.0    | 14.995/14.986 | 1.15               | 10.15              | 14.30              | 15              | 6002              |
| 7833401      | 41.0               | 16.0 | 17.0    | 19.995/19.986 | 1.35               | 13.35              | 19.00              | 20              | 6004              |
| 7833402      | 50.0               | 20.0 | 20.0    | 24.995/24.986 | 1.35               | 16.35              | 23.90              | 25              | 6205              |
| 7833403      | 59.0               | 21.0 | 25.0    | 29.995/29.985 | 1.75               | 17.75              | 28.60              | 30              | 6206              |
| 7833404      | 73.0               | 23.0 | 35.0    | 39.995/39.985 | 1.95               | 19.95              | 38.00              | 40              | 6208              |

### Bearing Supports / End Machining - Ball Splines

BF Standard End Machining

| Standard P/N | Type BF / BF1 (inch) |       |         |        |                    |                    |                    | *Snap Ring (mm) | Bearing Trade No. |
|--------------|----------------------|-------|---------|--------|--------------------|--------------------|--------------------|-----------------|-------------------|
|              | A                    | B     | C<br>h7 | D      | F<br>+0.006/-0.000 | G<br>+0.008/-0.000 | H<br>+0.000/-0.008 |                 |                   |
| 7833368      | 0.984                | 0.394 | 0.236   | 0.3148 | 0.035              | 0.311              | 0.299              | 8               | 608               |
| 7833372      | 1.614                | 0.630 | 0.669   | 0.7872 | 0.053              | 0.526              | 0.748              | 20              | 6004              |
| 7833373      | 1.969                | 0.787 | 0.787   | 0.9841 | 0.053              | 0.644              | 0.941              | 25              | 6205              |
| 7833375      | 2.974                | 0.906 | 1.378   | 1.5746 | 0.077              | 0.785              | 1.496              | 40              | 6208              |

\*DIN 471

## Bearing Supports/End Machining — Ball Screws

FK

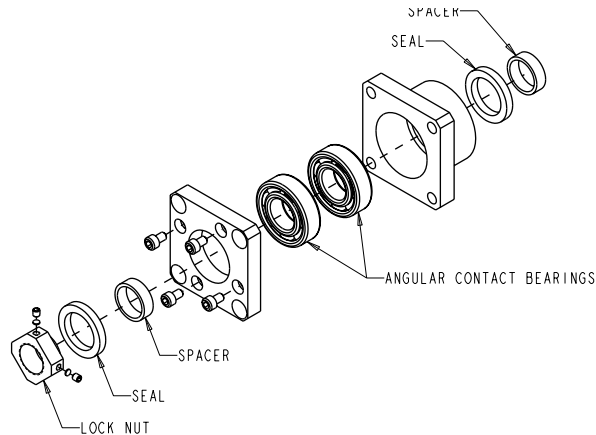

### Bearing Supports / End Machining - Inch Series Ball Screw

FK Bearing Supports

| Standard P/N | Dia. X Lead (inch)   | Bearing Rating      |       |       |                         |       |      | Lock Nut Type | Block Weight (lbs) |
|--------------|--|---------------------|-------|-------|-------------------------|-------|------|---------------|--------------------|
|              |  | Static Rating $C_0$ |       |       | Dynamic Rating $C_{am}$ |       |      |               |                    |
|              |  | (kgf)               | (lbs) | (N)   | (kgf)                   | (lbs) | (N)  |               |                    |
| 7833377      | 0.5  | 530                 | 1168  | 5197  | 195                     | 430   | 1912 | RN10          | 0.6                |
| 7833378      | 0.631  | 610                 | 1345  | 5982  | 217                     | 478   | 2128 | RN12          | 0.6                |
| 7833379      | 0.75   | 700                 | 1543  | 6864  | 240                     | 529   | 2353 | RN15          | 0.9                |
| 7833380      | 0.875  | 1220                | 2690  | 11963 | 413                     | 910   | 4050 | RN17          | 1.9                |
| 7833381      | 1.000 / 1.171  | 1690                | 3726  | 16572 | 587                     | 1294  | 5756 | RN20          | 2.5                |
| 7833382      | 1.150 / 1.250  | 2090                | 4608  | 20495 | 709                     | 1563  | 6952 | RN25          | 3.5                |
| 7833383      | 1.500 x 0.473 & 1.000<br>1.500 x 0.200 & 0.250<br>1.500 x 0.500 & 1.875<br>1.500 x 2.000 | 3000                | 6614  | 29418 | 939                     | 2070  | 9208 | RN30          | 5.2                |

### Bearing Supports / End Machining - Metric Series Ball Screw

FK Bearing Supports

| Standard P/N | Dia. X Lead (mm) | Bearing Rating      |       |       |                         |       |      | Lock Nut Type | Block Weight (kg) |
|--------------|------------------|---------------------|-------|-------|-------------------------|-------|------|---------------|-------------------|
|              |                  | Static Rating $C_0$ |       |       | Dynamic Rating $C_{am}$ |       |      |               |                   |
|              |                  | (kgf)               | (lbs) | (N)   | (kgf)                   | (lbs) | (N)  |               |                   |
| 7833405      | 12               | 530                 | 1168  | 5197  | 195                     | 430   | 1912 | RN10          | 0.3               |
| 7833406      | 16               | 610                 | 1345  | 5982  | 217                     | 478   | 2128 | RN12          | 0.3               |
| 7833407      | 20               | 700                 | 1543  | 6864  | 240                     | 529   | 2353 | RN15          | 0.4               |
| 7833408      | 25               | 1690                | 3726  | 16572 | 587                     | 1294  | 5756 | RN20          | 1.2               |
| 7833409      | 32               | 2090                | 4608  | 20495 | 709                     | 1563  | 6952 | RN25          | 1.6               |
| 7833410      | 40               | 3000                | 6614  | 29418 | 939                     | 2070  | 9208 | RN30          | 2.4               |

### Bearing Supports / End Machining - Ball Splines

FK Bearing Supports

| Standard P/N | Spline Size (inch) | Bearing Rating      |       |       |                         |       |      | Lock Nut Type | Block Weight (lbs) |
|--------------|--------------------|---------------------|-------|-------|-------------------------|-------|------|---------------|--------------------|
|              |                    | Static Rating $C_0$ |       |       | Dynamic Rating $C_{am}$ |       |      |               |                    |
|              |                    | (kgf)               | (lbs) | (N)   | (kgf)                   | (lbs) | (N)  |               |                    |
| 7833377      | 0.625              | 530                 | 1168  | 5197  | 195                     | 430   | 1912 | RN10          | 0.6                |
| 7833381      | 1.000              | 1690                | 3726  | 16572 | 587                     | 1294  | 5756 | RN20          | 2.5                |
| 7833382      | 1.500              | 2090                | 4608  | 20495 | 709                     | 1563  | 6952 | RN25          | 3.5                |



## Bearing Supports/End Machining — Ball Screws

FK

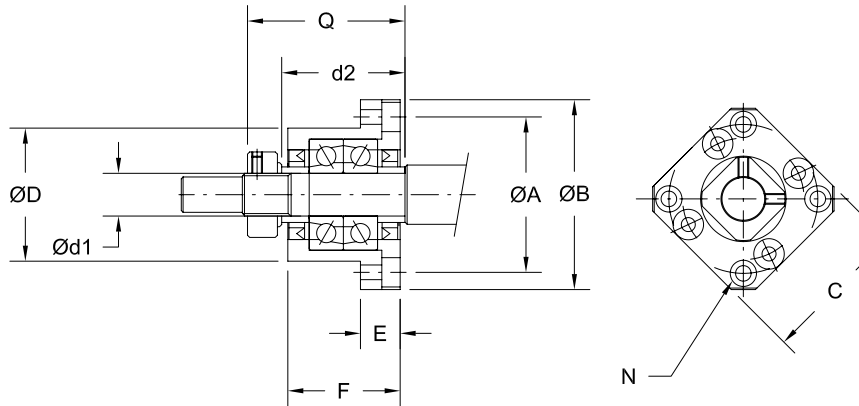

### Bearing Supports / End Machining - Inch Series Ball Screw

FK Bearing Supports

| Standard P/N | Bearing Block Dimensions (inch) |       |       |       |       |               |       |       |                                     |       |
|--------------|---------------------------------|-------|-------|-------|-------|---------------|-------|-------|-------------------------------------|-------|
|              | d1 (mm)                         | d2    | A     | B     | C     | D             | E     | F     | N                                   | Q     |
| 7833377      | 10                              | 1.063 | 1.654 | 2.047 | 1.654 | 1.3382/1.3376 | 0.394 | 1.063 | 4x .177 Thru, .315 C-Bore x .157 Dp | 1.299 |
| 7833378      | 12                              | 1.063 | 1.732 | 2.126 | 1.732 | 1.4170/1.4163 | 0.394 | 1.063 | 4x .177 Thru, .315 C-Bore x .157 Dp | 1.299 |
| 7833379      | 15                              | 1.496 | 1.969 | 2.480 | 2.047 | 1.5744/1.5738 | 0.591 | 1.260 | 4x .217 Thru, .374 C-Bore x .236 Dp | 1.575 |
| 7833380      | 17                              | 1.732 | 2.441 | 3.031 | 2.402 | 1.9681/1.9675 | 0.866 | 1.772 | 4x .260 Thru, .433 C-Bore x .394 Dp | 2.244 |
| 7833381      | 20                              | 1.969 | 2.756 | 3.346 | 2.677 | 2.2437/2.2430 | 0.866 | 2.047 | 4x .260 Thru, .433 C-Bore x .394 Dp | 2.598 |
| 7833382      | 25                              | 2.362 | 3.150 | 3.858 | 3.110 | 2.4799/2.4792 | 1.063 | 2.244 | 4x .354 Thru, .591 C-Bore x .512 Dp | 2.913 |
| 7833383      | 30                              | 1.969 | 3.740 | 4.606 | 3.661 | 2.9524/2.9516 | 1.181 | 2.441 | 4x .433 Thru, .689 C-Bore x .591 Dp | 3.150 |

### Bearing Supports / End Machining - Metric Series Ball Screw

FK Bearing Supports

| Standard P/N | Bearing Block Dimensions (mm) |      |      |       |      |      |      |      |                                     |      |
|--------------|-------------------------------|------|------|-------|------|------|------|------|-------------------------------------|------|
|              | d1 (mm)                       | d2   | A    | B     | C    | D g6 | E    | F    | N                                   | Q    |
| 7833405      | 10                            | 27.0 | 42.0 | 52.0  | 42.0 | 34.0 | 10.0 | 27.0 | 4x 4.5 Thru, 8.0 C-Bore x 4.0 Dp    | 33.0 |
| 7833406      | 12                            | 27.0 | 44.0 | 54.0  | 44.0 | 36.0 | 10.0 | 27.0 | 4x 4.5 Thru, 8.0 C-Bore x 4.0 Dp    | 33.0 |
| 7833407      | 15                            | 38.0 | 50.0 | 63.0  | 52.0 | 40.0 | 15.0 | 32.0 | 4x 5.5 Thru, 9.5 C-Bore x 6.0 Dp    | 40.0 |
| 7833408      | 20                            | 50.0 | 70.0 | 85.0  | 68.0 | 57.0 | 22.0 | 52.0 | 4x 6.6 Thru, 11.0 C-Bore x 10.0 Dp  | 66.0 |
| 7833409      | 25                            | 60.0 | 80.0 | 98.0  | 79.0 | 63.0 | 27.0 | 57.0 | 4x 9.0 Thru, 15.0 C-Bore x 13.0 Dp  | 74.0 |
| 7833410      | 30                            | 50.0 | 95.0 | 117.0 | 93.0 | 75.0 | 30.0 | 62.0 | 4x 11.0 Thru, 17.5 C-Bore x 15.0 Dp | 80.0 |

### Bearing Supports / End Machining - Ball Splines

FK Bearing Supports

| Standard P/N | Bearing Block Dimensions (inch) |       |       |       |       |               |       |       |                                     |       |
|--------------|---------------------------------|-------|-------|-------|-------|---------------|-------|-------|-------------------------------------|-------|
|              | d1 (mm)                         | d2    | A     | B     | C     | D             | E     | F     | N                                   | Q     |
| 7833377      | 10                              | 1.063 | 1.654 | 2.047 | 1.654 | 1.3382/1.3376 | 0.394 | 1.063 | 4x .177 Thru, .315 C-Bore x .157 Dp | 1.339 |
| 7833381      | 20                              | 1.969 | 2.756 | 3.346 | 2.677 | 2.2437/2.2430 | 0.866 | 2.047 | 4x .260 Thru, .433 C-Bore x .394 Dp | 2.008 |
| 7833382      | 25                              | 2.362 | 3.150 | 3.858 | 3.110 | 2.4799/2.4792 | 1.063 | 2.244 | 4x .354 Thru, .591 C-Bore x .512 Dp | 2.480 |

## Bearing Supports/End Machining — Ball Screws

FF

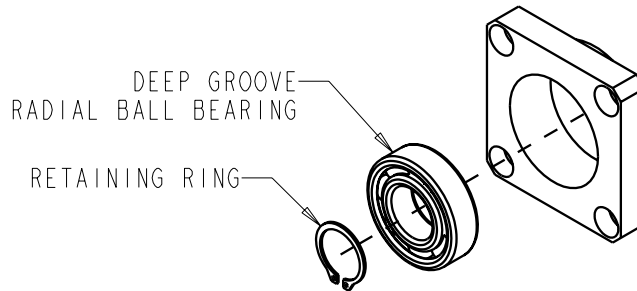

### Bearing Supports / End Machining - Inch Series Ball Screw

FF Bearing Supports

| Standard P/N | Dia. X Lead (inch)    | *Snap Ring (mm) | Block Weight (lbs) |
|--------------|-----------------------|-----------------|--------------------|
| 7833384      | 0.5                   | 8               | 0.2                |
| 7833385      | 0.631                 | 10              | 0.3                |
| 7833386      | 0.75                  | 15              | 0.5                |
| 7833387      | 0.875                 | 17              | 0.8                |
| 7833388      | 1.000 / 1.171         | 20              | 1.0                |
| 7833389      | 1.150 / 1.250         | 25              | 1.5                |
| 7833390      | 1.500 x 0.473 & 1.000 | 30              | 2.3                |
|              | 1.500 x 0.200 & 0.250 |                 |                    |
|              | 1.500 x 0.500 & 1.875 |                 |                    |
|              | 1.500 x 2.000         |                 |                    |

### Bearing Supports / End Machining - Metric Series Ball Screw

FF Bearing Supports

| Standard P/N | Dia. X Lead (mm) | *Snap Ring (mm) | Block Weight (kg) |
|--------------|------------------|-----------------|-------------------|
| 7833411      | 12               | 8               | 0.1               |
| 7833412      | 16               | 10              | 0.2               |
| 7833413      | 20               | 15              | 0.2               |
| 7833414      | 25               | 20              | 0.5               |
| 7833415      | 32               | 25              | 0.7               |
| 7833416      | 40               | 30              | 1.1               |

### Bearing Supports / End Machining - Ball Splines

FF Bearing Supports

| Standard P/N | Spline Size (inch) | *Snap Ring (mm) | Block Weight (lbs) |
|--------------|--------------------|-----------------|--------------------|
| 7833384      | 0.625              | 8               | 0.2                |
| 7833388      | 1.000              | 20              | 1.0                |
| 7833389      | 1.500              | 25              | 1.5                |

\*DIN 471

## Bearing Supports/End Machining — Ball Screws

FF

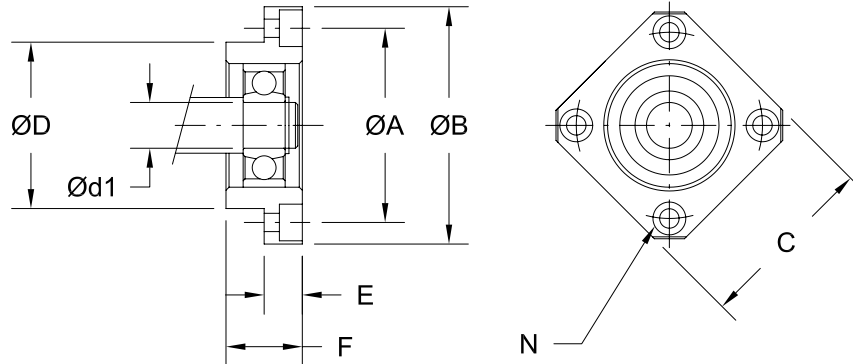

### Bearing Supports / End Machining - Inch Series Ball Screw

FF Bearing Supports

| Standard P/N | Bearing Block Dimensions (inch) |       |       |       |               |       |       |                                     |
|--------------|---------------------------------|-------|-------|-------|---------------|-------|-------|-------------------------------------|
|              | d1 (mm)                         | A     | B     | C     | D             | E     | F     | N                                   |
| 7833384      | 8                               | 1.378 | 1.693 | 1.378 | 1.1021/1.1016 | 0.276 | 0.472 | 4x .134 Thru, .256 C-Bore x .157 Dp |
| 7833385      | 10                              | 1.654 | 2.047 | 1.654 | 1.3382/1.3376 | 0.276 | 0.591 | 4x .177 Thru, .315 C-Bore x .157 Dp |
| 7833386      | 15                              | 1.969 | 2.480 | 2.047 | 1.5744/1.5738 | 0.354 | 0.669 | 4x .217 Thru, .374 C-Bore x .217 Dp |
| 7833387      | 17                              | 2.441 | 3.031 | 2.402 | 1.9681/1.9675 | 0.433 | 0.787 | 4x .260 Thru, .433 C-Bore x .256 Dp |
| 7833388      | 20                              | 2.756 | 3.346 | 2.677 | 2.2437/2.2430 | 0.433 | 0.787 | 4x .260 Thru, .433 C-Bore x .256 Dp |
| 7833389      | 25                              | 3.150 | 3.858 | 3.110 | 2.4799/2.4792 | 0.551 | 0.945 | 4x .354 Thru, .551 C-Bore x .335 Dp |
| 7833390      | 30                              | 3.740 | 4.606 | 3.661 | 2.9524/2.9516 | 0.709 | 1.063 | 4x .433 Thru, .669 C-Bore x .433 Dp |

### Bearing Supports / End Machining - Metric Series Ball Screw

FF Bearing Supports

| Standard P/N | Bearing Block Dimensions (mm) |      |       |      |      |      |      |                                      |
|--------------|-------------------------------|------|-------|------|------|------|------|--------------------------------------|
|              | d1 (mm)                       | A    | B     | C    | D    | E    | F    | N                                    |
| 7833411      | 8                             | 35.0 | 43.0  | 35.0 | 28.0 | 7.0  | 12.0 | 4x 3.4 Thru, 6.5 C-Bore x 4.0 Dp     |
| 7833412      | 10                            | 42.0 | 52.0  | 42.0 | 34.0 | 7.0  | 15.0 | 4x 4.5 dia Thru, 8.0 C-Bore x 4.0 Dp |
| 7833413      | 15                            | 50.0 | 63.0  | 52.0 | 40.0 | 9.0  | 17.0 | 4x 5.5 Thru, 9.5 C-Bore x 5.5 Dp     |
| 7833414      | 20                            | 70.0 | 85.0  | 68.0 | 57.0 | 11.0 | 20.0 | 4x 6.6 Thru, 11.0 C-Bore x 6.5 Dp    |
| 7833415      | 25                            | 80.0 | 98.0  | 79.0 | 63.0 | 14.0 | 24.0 | 4x 9.0 Thru, 14.0 C-Bore x 8.5 Dp    |
| 7833416      | 30                            | 95.0 | 117.0 | 93.0 | 75.0 | 18.0 | 27.0 | 4x 11.0 Thru, 17.0 C-Bore x 11.0 Dp  |

### Bearing Supports / End Machining - Ball Splines

FF Bearing Supports

| Standard P/N | Bearing Block Dimensions (inch) |       |       |       |               |       |       |                                     |
|--------------|---------------------------------|-------|-------|-------|---------------|-------|-------|-------------------------------------|
|              | d1 (mm)                         | A     | B     | C     | D             | E     | F     | N                                   |
| 7833384      | 8                               | 1.378 | 1.693 | 1.378 | 1.1021/1.1016 | 0.276 | 0.472 | 4x .134 Thru, .256 C-Bore x .157 Dp |
| 7833388      | 20                              | 2.756 | 3.346 | 2.677 | 2.2437/2.2430 | 0.433 | 0.787 | 4x .260 Thru, .433 C-Bore x .256 Dp |
| 7833389      | 25                              | 3.150 | 3.858 | 3.110 | 2.4799/2.4792 | 0.551 | 0.945 | 4x .354 Thru, .551 C-Bore x .335 Dp |

## Bearing Supports/End Machining — Ball Screws

FK

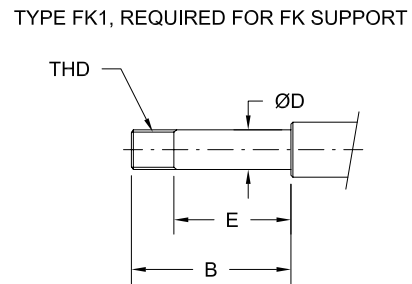
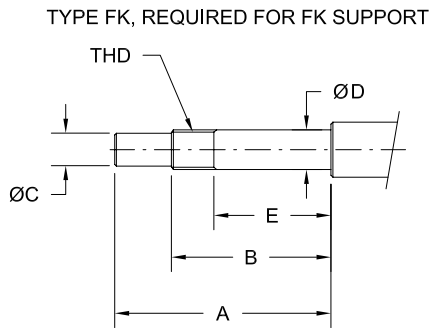

### Bearing Supports / End Machining - Inch Series Ball Screw

FK Standard End Machining

| Dia x Lead<br>(inch)  | Standard<br>P/N | Type FK / FK1 (inch) |       |             |               |       |         | Bearing Trade<br>No. |
|-----------------------|-----------------|----------------------|-------|-------------|---------------|-------|---------|----------------------|
|                       |                 | A                    | B     | C           | D             | E     | THD     |                      |
| 0.500                 | 7833377         | 2.008                | 1.417 | .3150/.3144 | .3935/.3932   | 0.984 | M10x1   | 7000                 |
| 0.631                 | 7833378         | 2.008                | 1.417 | .3937/.3931 | .4722/.4720   | 0.984 | M12x1   | 7001                 |
| 0.750                 | 7833379         | 2.638                | 1.850 | .4724/.4717 | .5904/.5900   | 1.339 | M15x1   | 7002                 |
| 0.875                 | 7833380         | 3.189                | 2.283 | .5906/.5898 | .6691/.6687   | 1.693 | M17x1   | 7203                 |
| 1.000 / 1.171         | 7833381         | 3.425                | 2.441 | .6693/.6686 | .7872/.7869   | 1.772 | M20x1   | 7204                 |
| 1.150 / 1.250         | 7833382         | 4.173                | 2.992 | .7874/.7866 | .9841/.9837   | 2.205 | M25x1.5 | 7205                 |
| 1.500 x 0.473 & 1.000 | 7833383         | 4.331                | 2.835 | .9843/.9834 | 1.1809/1.1805 | 1.850 | M30x1.5 | 7206                 |
| 1.500 x 0.200 & 0.250 |                 |                      |       |             |               |       |         |                      |
| 1.500 x 0.500 & 1.875 |                 |                      |       |             |               |       |         |                      |
| 1.500 x 2.000         |                 |                      |       |             |               |       |         |                      |

### Bearing Supports / End Machining - Metric Series Ball Screw

FK Standard End Machining

| Dia x Lead<br>(mm) | Standard<br>P/N | Type FK / FK1 (mm) |      |      |               |      |         | Bearing Trade<br>No. |
|--------------------|-----------------|--------------------|------|------|---------------|------|---------|----------------------|
|                    |                 | A                  | B    | C    | D             | E    | THD     |                      |
| 12                 | 7833405         | 51.0               | 36.0 | 8.0  | 9.995/9.988   | 25.0 | M10x1   | 7000                 |
| 16                 | 7833406         | 51.0               | 36.0 | 10.0 | 11.995/11.988 | 25.0 | M12x1   | 7001                 |
| 20                 | 7833407         | 67.0               | 47.0 | 12.0 | 14.995/14.986 | 34.0 | M15x1   | 7002                 |
| 25                 | 7833408         | 87.0               | 62.0 | 17.0 | 19.995/19.986 | 45.0 | M20x1   | 7204                 |
| 32                 | 7833409         | 106.0              | 76.0 | 20.0 | 24.995/24.985 | 56.0 | M25x1.5 | 7205                 |
| 40                 | 7833410         | 110.0              | 72.0 | 25.0 | 29.995/29.985 | 47.0 | M30x1.5 | 7206                 |

### Bearing Supports / End Machining - Ball Splines

FK Standard End Machining

| Spline Size<br>(inch) | Standard<br>P/N | Type FK / FK1 (inch) |       |             |             |       |         | Bearing Trade<br>No. |
|-----------------------|-----------------|----------------------|-------|-------------|-------------|-------|---------|----------------------|
|                       |                 | A                    | B     | C           | D           | E     | THD     |                      |
| 0.625                 | 7833377         | 2.008                | 1.417 | .3150/.3144 | .3935/.3932 | 0.984 | M10x1   | 7000                 |
| 1.000                 | 7833381         | 3.425                | 2.441 | .6693/.6686 | .7872/.7869 | 1.772 | M20x1   | 7204                 |
| 1.500                 | 7833382         | 4.173                | 2.992 | .7874/.7866 | .9841/.9837 | 2.205 | M25x1.5 | 7205                 |

## Bearing Supports/End Machining — Ball Screws

FF

TYPE FF, REQUIRED FOR FF SUPPORT

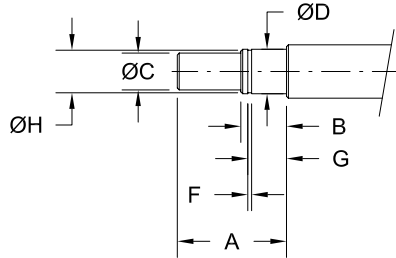

TYPE FF1, REQUIRED FOR FF SUPPORT

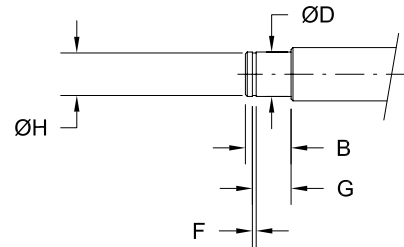

### Bearing Supports / End Machining - Inch Series Ball Screw

FF Standard End Machining

| Standard P/N | Type FF / FF1 (inch) |       |         |               |                    |                    |                    | *Snap Ring (mm) | Bearing Trade No. |
|--------------|----------------------|-------|---------|---------------|--------------------|--------------------|--------------------|-----------------|-------------------|
|              | A                    | B     | C<br>h7 | D             | F<br>+0.006/-0.000 | G<br>+0.008/-0.000 | H<br>+0.000/-0.008 |                 |                   |
| 7833384      | 0.984                | 0.394 | 0.236   | .3148/.3145   | 0.035              | 0.311              | 0.299              | 8               | 608               |
| 7833385      | 1.024                | 0.433 | 0.315   | .3935/.3932   | 0.045              | 0.360              | 0.378              | 10              | 6000              |
| 7833386      | 1.299                | 0.512 | 0.472   | .5904/.5900   | 0.045              | 0.400              | 0.563              | 15              | 6002              |
| 7833387      | 1.535                | 0.630 | 0.591   | .6691/.6687   | 0.045              | 0.518              | 0.638              | 17              | 6203              |
| 7833388      | 1.614                | 0.748 | 0.669   | .7872/.7869   | 0.053              | 0.604              | 0.748              | 20              | 6204              |
| 7833389      | 1.969                | 0.787 | 0.787   | .9841/.9837   | 0.053              | 0.644              | 0.941              | 25              | 6205              |
| 7833390      | 2.323                | 0.827 | 0.984   | 1.1809/1.1805 | 0.069              | 0.699              | 1.126              | 30              | 6206              |

### Bearing Supports / End Machining - Metric Series Ball Screw

FF Standard End Machining

| Standard P/N | Type FF / FF1 (mm) |      |         |               |                    |                    |                    | *Snap Ring (mm) | Bearing Trade No. |
|--------------|--------------------|------|---------|---------------|--------------------|--------------------|--------------------|-----------------|-------------------|
|              | A                  | B    | C<br>h7 | D             | F<br>+0.140/-0.000 | G<br>+0.200/-0.000 | H<br>+0.000/-0.200 |                 |                   |
| 7833411      | 25.0               | 10.0 | 6.0     | 7.995/7.988   | 0.90               | 7.90               | 7.60               | 8               | 608               |
| 7833412      | 26.0               | 11.0 | 8.0     | 9.995/9.988   | 1.15               | 9.15               | 9.60               | 10              | 6000              |
| 7833413      | 33.0               | 13.0 | 12.0    | 14.995/14.986 | 1.15               | 10.15              | 14.30              | 15              | 6002              |
| 7833414      | 41.0               | 19.0 | 17.0    | 19.995/19.986 | 1.35               | 15.35              | 19.00              | 20              | 6204              |
| 7833415      | 50.0               | 20.0 | 20.0    | 24.995/24.986 | 1.35               | 16.35              | 23.90              | 25              | 6205              |
| 7833416      | 59.0               | 21.0 | 25.0    | 29.995/29.985 | 1.75               | 17.75              | 28.60              | 30              | 6206              |

### Bearing Supports / End Machining - Ball Splines

FF Standard End Machining

| Standard P/N | Type FF / FF1 (inch) |       |         |             |                    |                    |                    | *Snap Ring (mm) | Bearing Trade No. |
|--------------|----------------------|-------|---------|-------------|--------------------|--------------------|--------------------|-----------------|-------------------|
|              | A                    | B     | C<br>h7 | D           | F<br>+0.006/-0.000 | G<br>+0.008/-0.000 | H<br>+0.000/-0.008 |                 |                   |
| 7833384      | 0.984                | 0.394 | 0.236   | .3148/.3145 | 0.035              | 0.311              | 0.299              | 8               | 608               |
| 7833388      | 1.614                | 0.748 | 0.669   | .7872/.7869 | 0.053              | 0.604              | 0.748              | 20              | 6204              |
| 7833389      | 1.969                | 0.787 | 0.787   | .9841/.9837 | 0.053              | 0.644              | 0.941              | 25              | 6205              |

\*DIN 471

## Motor Supports

MK

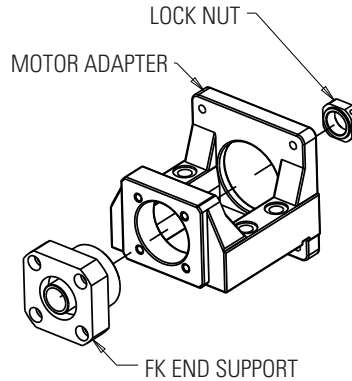

### Motor Supports - Inch Series Ball Screw

MK Motor Supports

| Standard P/N | Dia. X Lead (inch) | Bearing Rating      |       |       |                         |       |      | Lock Nut Type |
|--------------|--------------------|---------------------|-------|-------|-------------------------|-------|------|---------------|
|              |                    | Static Rating $C_0$ |       |       | Dynamic Rating $C_{am}$ |       |      |               |
|              |                    | (kgf)               | (lbs) | (N)   | (kgf)                   | (lbs) | (N)  |               |
| 7833685      | 0.5                | 530                 | 1168  | 5197  | 195                     | 430   | 1912 | RN10          |
| 7833686      | 0.631              | 610                 | 1345  | 5982  | 217                     | 478   | 2128 | RN12          |
| 7833687      | 0.75               | 700                 | 1543  | 6864  | 240                     | 529   | 2353 | RN15          |
| 7833690      | 1.000 / 1.171      | 1690                | 3726  | 16572 | 587                     | 1294  | 5756 | RN20          |

### Motor Supports - Metric Series Ball Screw

MK Motor Supports

| Standard P/N | Dia. X Lead (mm) | Bearing Rating      |       |       |                         |       |      | Lock Nut Type |
|--------------|------------------|---------------------|-------|-------|-------------------------|-------|------|---------------|
|              |                  | Static Rating $C_0$ |       |       | Dynamic Rating $C_{am}$ |       |      |               |
|              |                  | (kgf)               | (lbs) | (N)   | (kgf)                   | (lbs) | (N)  |               |
| 7833700      | 12               | 530                 | 1168  | 5197  | 195                     | 430   | 1912 | RN10          |
| 7833701      | 16               | 610                 | 1345  | 5982  | 217                     | 478   | 2128 | RN12          |
| 7833702      | 20               | 700                 | 1543  | 6864  | 240                     | 529   | 2353 | RN15          |
| 7833703      | 25               | 1690                | 3726  | 16572 | 587                     | 1294  | 5756 | RN20          |

## Motor Supports

MK

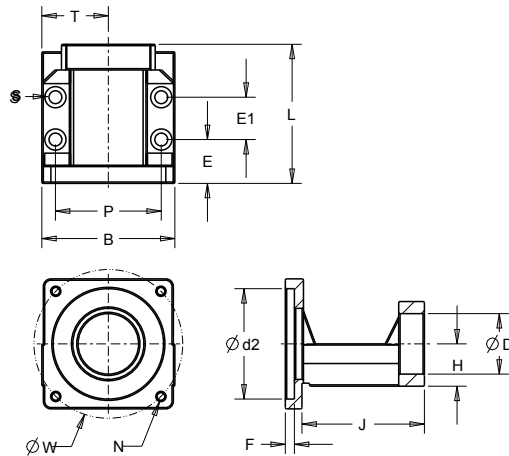

### Motor Supports - Inch Series Ball Screw

MK Motor Supports

| Standard P/N | Bearing Block Dimensions (inch) |       |       |    |       |       |          |       |       |       |       |       |       |       | Support Unit | Frame Size | S                                   |
|--------------|---------------------------------|-------|-------|----|-------|-------|----------|-------|-------|-------|-------|-------|-------|-------|--------------|------------|-------------------------------------|
|              | d1 (mm)                         | d2    | W     | N  | D     | L     | H ±0.001 | B     | P     | T     | E     | E1    | F     | J     |              |            |                                     |
| 7833685      | 10                              | 1.500 | 2.626 | M4 | 1.339 | 2.913 | 0.866    | 2.559 | 1.969 | 1.280 | 0.945 | 0.787 | 0.157 | 2.559 | 7833377      | NEMA 23    | 4x .260 Thru, .441 C-Bore x .236 Dp |
| 7833686      | 12                              | 1.500 | 2.626 | M4 | 1.417 | 2.913 | 0.984    | 2.559 | 1.969 | 1.280 | 0.945 | 0.787 | 0.157 | 2.559 | 7833378      | NEMA 23    | 4x .260 Thru, .441 C-Bore x .236 Dp |
| 7833687      | 15                              | 1.500 | 2.626 | M4 | 1.575 | 3.228 | 1.102    | 2.756 | 2.165 | 1.378 | 0.945 | 1.102 | 0.157 | 2.874 | 7833379      | NEMA 23    | 4x .260 Thru, .441 C-Bore x .236 Dp |
| 7833690      | 20                              | 2.874 | 3.874 | M6 | 2.244 | 4.449 | 1.339    | 3.465 | 2.756 | 1.732 | 1.142 | 1.654 | 0.236 | 4.016 | 7833691      | NEMA 34    | 4x .335 Thru, .571 C-Bore x .315 Dp |

### Motor Supports - Metric Series Ball Screw

MK Motor Supports

| Standard P/N | Bearing Block Dimensions (mm) |      |      |    |    |     |         |    |    |      |    |    |   |     | Support Unit | Frame Size | S                                 |
|--------------|-------------------------------|------|------|----|----|-----|---------|----|----|------|----|----|---|-----|--------------|------------|-----------------------------------|
|              | d1 (mm)                       | d2   | W1   | N  | D  | L   | H ±0.02 | B  | P  | T    | E  | E1 | F | J   |              |            |                                   |
| 7833700      | 10                            | 38.1 | 66.7 | M4 | 34 | 74  | 22.00   | 65 | 50 | 32.5 | 24 | 20 | 4 | 65  | 7833405      | NEMA 23    | 4x 6.6 Thru, 11.2 C-Bore x 6.0 Dp |
| 7833701      | 12                            | 38.1 | 66.7 | M4 | 36 | 74  | 25.00   | 65 | 50 | 32.5 | 24 | 20 | 4 | 65  | 7833406      | NEMA 23    | 4x 6.6 Thru, 11.2 C-Bore x 6.0 Dp |
| 7833702      | 15                            | 38.1 | 66.7 | M4 | 40 | 82  | 28.00   | 70 | 55 | 35.0 | 24 | 28 | 4 | 73  | 7833407      | NEMA 23    | 4x 6.6 Thru, 11.2 C-Bore x 6.0 Dp |
| 7833703      | 20                            | 73.0 | 98.4 | M6 | 57 | 113 | 34.00   | 88 | 70 | 44.0 | 29 | 42 | 6 | 102 | 7833707      | NEMA 34    | 4x 8.5 Thru, 14.5 C-Bore x 8.0 Dp |

## Bearing Supports/End Machining — Ball Screws

WK

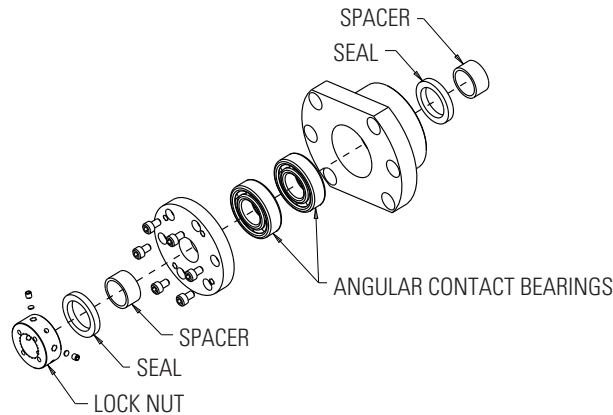

### Bearing Supports / End Machining - Inch Series Ball Screw

WK Bearing Supports

| Standard P/N | Dia. X Lead (inch)   | Bearing Rating      |       |       |                         |       |       | Lock Nut Type | Block Weight (lbs) |
|--------------|--|---------------------|-------|-------|-------------------------|-------|-------|---------------|--------------------|
|              |  | Static Rating $C_0$ |       |       | Dynamic Rating $C_{am}$ |       |       |               |                    |
|              |  | (kgf)               | (lbs) | (N)   | (kgf)                   | (lbs) | (N)   |               |                    |
| 7833595      | 0.875  | 2710                | 5974  | 26574 | 2240                    | 4938  | 21966 | M17x1         | 4.2                |
| 7833596      | 1.000 / 1.171  | 2710                | 5974  | 26574 | 2240                    | 4938  | 21966 | M20x1         | 4.2                |
| 7833597      | 1.150 / 1.250  | 4150                | 9149  | 40695 | 2910                    | 6415  | 28536 | M25x1.5       | 6.8                |
| 7833599      | 1.500 x 0.473 & 1.000<br>1.500 x 0.200 & 0.250<br>1.500 x 0.500 & 1.875<br>1.500 x 2.000 | 4400                | 9700  | 43147 | 2980                    | 6570  | 29222 | M30x1.5       | 6.6                |
| 7833602      | 1.750 / 2.000  | 5300                | 11684 | 51972 | 3250                    | 7165  | 31870 | M40x1.5       | 7.9                |

### Bearing Supports / End Machining - Metric Series Ball Screw

WK Bearing Supports

| Standard P/N | Dia. X Lead (mm) | Bearing Rating      |       |       |                         |       |       | Lock Nut Type | Block Weight (kg) |
|--------------|------------------|---------------------|-------|-------|-------------------------|-------|-------|---------------|-------------------|
|              |                  | Static Rating $C_0$ |       |       | Dynamic Rating $C_{am}$ |       |       |               |                   |
|              |                  | (kgf)               | (lbs) | (N)   | (kgf)                   | (lbs) | (N)   |               |                   |
| 7833614      | 25               | 2710                | 5974  | 26574 | 2240                    | 4938  | 21966 | M20x1         | 1.9               |
| 7833615      | 32               | 4150                | 9149  | 40695 | 2910                    | 6415  | 28536 | M25x1.5       | 3.1               |
| 7833617      | 40               | 4400                | 9700  | 43147 | 2980                    | 6570  | 29222 | M30x1.5       | 3.0               |
| 7833621      | 50               | 5300                | 11684 | 51972 | 3250                    | 7165  | 31870 | M40x1.5       | 3.6               |

### Bearing Supports / End Machining - Ball Splines

WK Bearing Supports

| Standard P/N | Spline Size (inch) | Bearing Rating      |       |       |                         |       |       | Lock Nut Type | Block Weight (lbs) |
|--------------|--------------------|---------------------|-------|-------|-------------------------|-------|-------|---------------|--------------------|
|              |                    | Static Rating $C_0$ |       |       | Dynamic Rating $C_{am}$ |       |       |               |                    |
|              |                    | (kgf)               | (lbs) | (N)   | (kgf)                   | (lbs) | (N)   |               |                    |
| 7833596      | 1.000              | 2710                | 5974  | 26574 | 2240                    | 4938  | 21966 | M20x1         | 4.2                |
| 7833597      | 1.500              | 4150                | 9149  | 40695 | 2910                    | 6415  | 28536 | M25x1.5       | 6.8                |
| 7833602      | 2.000              | 5300                | 11684 | 51972 | 3250                    | 7165  | 31870 | M40x1.5       | 7.9                |



## Bearing Supports/End Machining — Ball Screws

WK

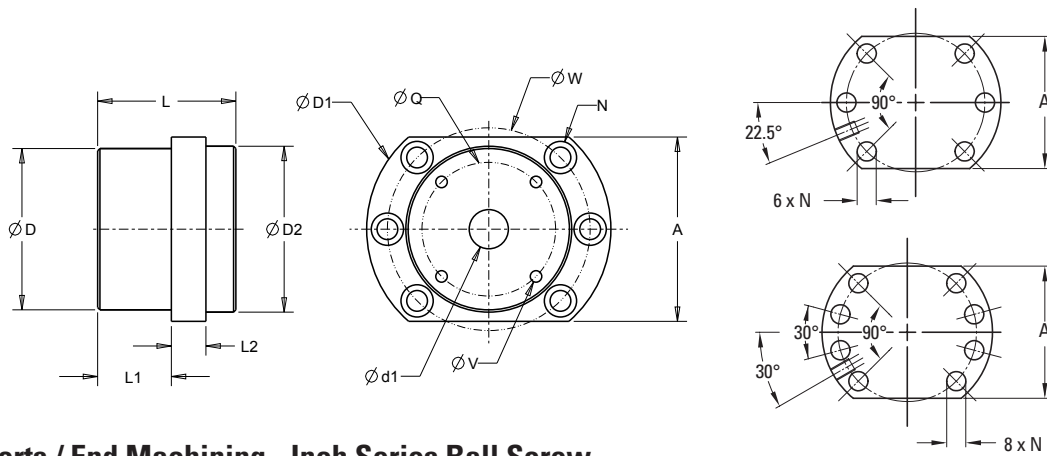

### Bearing Supports / End Machining - Inch Series Ball Screw

WK Bearing Supports

| Standard P/N | Bearing Block Dimensions (inch) |       |       |       |       |       |       |       |       |                                     |       |                      |
|--------------|---------------------------------|-------|-------|-------|-------|-------|-------|-------|-------|-------------------------------------|-------|----------------------|
|              | d1 (mm)                         | D g6  | D1    | D2    | L     | L1    | L2    | A     | W     | N                                   | V     | Q                    |
| 7833595      | 17                              | 2.756 | 4.173 | 2.835 | 2.362 | 1.260 | 0.591 | 3.150 | 3.465 | 6x .354 Thru, .551 C-Bore x .335 Dp | 2.283 | 4x M5 THD, x .394 Dp |
| 7833596      | 20                              | 2.756 | 4.173 | 2.835 | 2.362 | 1.260 | 0.591 | 3.150 | 3.465 | 6x .433 Thru, .669 C-Bore x .433 Dp | 2.283 | 4x M5 THD, x .472 Dp |
| 7833597      | 25                              | 3.346 | 5.118 | 3.543 | 2.598 | 1.299 | 0.709 | 3.937 | 4.331 | 6x .433 Thru, .669 C-Bore x .433 Dp | 2.756 | 4x M6 THD, x .472 Dp |
| 7833599      | 30                              | 3.346 | 5.118 | 3.543 | 2.598 | 1.299 | 0.709 | 3.937 | 4.331 | 6x .433 Thru, .669 C-Bore x .433 Dp | 2.756 | 4x M6 THD, x .472 Dp |
| 7833602      | 40                              | 3.740 | 5.591 | 4.016 | 2.598 | 1.299 | 0.709 | 4.173 | 4.764 | 8x .433 Thru, .669 C-Bore x .433 Dp | 3.150 | 4x M6 THD, x .472 Dp |

### Bearing Supports / End Machining - Metric Series Ball Screw

WK Bearing Supports

| Standard P/N | Bearing Block Dimensions (mm) |      |       |       |      |      |      |       |        |                                   |    |                    |
|--------------|-------------------------------|------|-------|-------|------|------|------|-------|--------|-----------------------------------|----|--------------------|
|              | d1 (mm)                       | D g6 | D1    | D2    | L    | L1   | L2   | A     | W      | N                                 | V  | Q                  |
| 7833614      | 20                            | 70.0 | 106.0 | 72.0  | 60.0 | 32.0 | 15.0 | 80.0  | 88.00  | 6x 9.0 Thru, 14.0 C-Bore x 8.5 Dp | 58 | 4x M5 THD, x 10 Dp |
| 7833615      | 25                            | 85.0 | 130.0 | 90.0  | 66.0 | 33.0 | 18.0 | 100.0 | 110.00 | 6x 11.0 Thru, 17.0 C-Bore x 11 Dp | 70 | 4x M6 THD, x 12 Dp |
| 7833617      | 30                            | 85.0 | 130.0 | 90.0  | 66.0 | 33.0 | 18.0 | 100.0 | 110.00 | 6x 11.0 Thru, 17.0 C-Bore x 11 Dp | 70 | 4x M6 THD, x 12 Dp |
| 7833621      | 40                            | 95.0 | 142.0 | 102.0 | 66.0 | 33.0 | 18.0 | 106.0 | 121.00 | 8x 11.0 Thru, 17.0 C-Bore x 11 Dp | 80 | 4x M6 THD, x 12 Dp |

### Bearing Supports / End Machining - Ball Splines

WK Bearing Supports

| Standard P/N | Bearing Block Dimensions (inch) |       |       |       |       |        |       |       |       |                                     |             |                      |
|--------------|---------------------------------|-------|-------|-------|-------|--------|-------|-------|-------|-------------------------------------|-------------|----------------------|
|              | d1 (mm)                         | D g6  | D1    | D2    | L     | L1     | L2    | A     | W     | N                                   | V           | Q                    |
| 7833596      | 20                              | 2.756 | 4.173 | 2.835 | 2.362 | 1.2598 | 0.591 | 3.150 | 3.465 | 6x .433 Thru, .669 C-Bore x .433 Dp | 2.283464567 | 4x M5 THD, x .472 Dp |
| 7833597      | 25                              | 3.346 | 5.118 | 3.543 | 2.598 | 1.2992 | 0.709 | 3.937 | 4.331 | 6x .433 Thru, .669 C-Bore x .433 Dp | 2.755905512 | 4x M6 THD, x .472 Dp |
| 7833602      | 40                              | 3.740 | 5.591 | 4.016 | 2.598 | 1.2992 | 0.709 | 4.173 | 4.764 | 8x .433 Thru, .669 C-Bore x .433 Dp | 3.149606299 | 4x M6 THD, x .472 Dp |

## Bearing Supports/End Machining — Ball Screws

MK

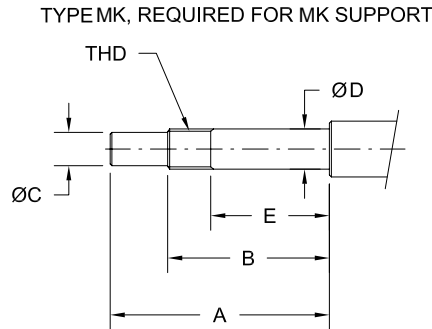

### Bearing Supports / End Machining - Inch Series Ball Screw

MK Standard End Machining

| Dia x Lead<br>(inch) | Standard<br>P/N | Type MK (inch) |       |             |             |       |       | Bearing Trade<br>No. |
|----------------------|-----------------|----------------|-------|-------------|-------------|-------|-------|----------------------|
|                      |                 | A              | B     | C           | D           | E     | THD   |                      |
| 0.500                | 7833685         | 2.008          | 1.417 | .3150/.3144 | .3935/.3932 | 0.984 | M10x1 | 7000                 |
| 0.631                | 7833686         | 2.008          | 1.417 | .3937/.3931 | .4722/.4720 | 0.984 | M12x1 | 7001                 |
| 0.750                | 7833687         | 2.638          | 1.850 | .4724/.4717 | .5904/.5900 | 1.339 | M15x1 | 7002                 |
| 1.000 / 1.171        | 7833690         | 3.425          | 2.441 | .6693/.6686 | .7872/.7869 | 1.772 | M20x1 | 7204                 |

### Bearing Supports / End Machining - Metric Series Ball Screw

MK Standard End Machining

| Dia x Lead<br>(mm) | Standard<br>P/N | Type MK (mm) |      |         |               |      |       | Bearing Trade<br>No. |
|--------------------|-----------------|--------------|------|---------|---------------|------|-------|----------------------|
|                    |                 | A            | B    | C<br>h7 | D             | E    | THD   |                      |
| 12                 | 7833700         | 51.0         | 36.0 | 8.0     | 9.995/9.988   | 25.0 | M10x1 | 7000                 |
| 16                 | 7833701         | 51.0         | 36.0 | 10.0    | 11.995/11.988 | 25.0 | M12x1 | 7001                 |
| 20                 | 7833702         | 67.0         | 47.0 | 12.0    | 14.995/14.986 | 34.0 | M15x1 | 7002                 |
| 25                 | 7833703         | 87.0         | 62.0 | 17.0    | 19.995/19.986 | 45.0 | M20x1 | 7204                 |

## Bearing Supports/End Machining — Ball Screws

WK

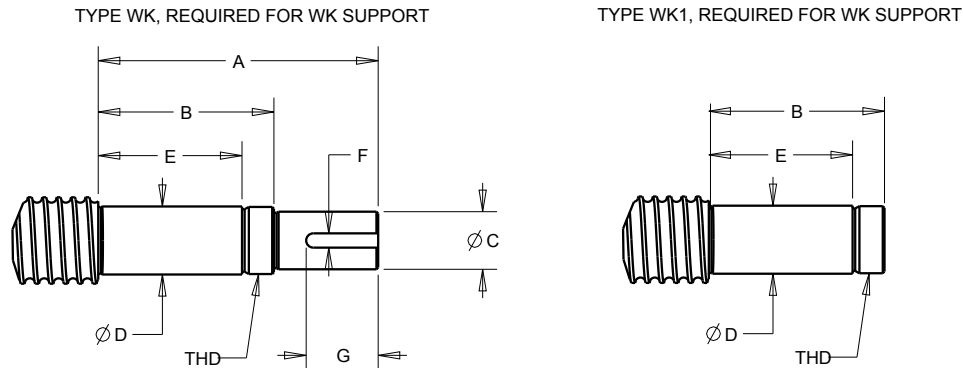

### Bearing Supports / End Machining - Inch Series Ball Screw

WK Standard End Machining

| Dia x Lead (inch)     | Standard P/N | Type WK / WK1 (inch) |       |               |                |       |       |       |         |
|-----------------------|--------------|----------------------|-------|---------------|----------------|-------|-------|-------|---------|
|                       |              | A                    | B     | C             | D              | E     | F     | G     | THD     |
| 0.875                 | 7833595      | 4.528                | 3.189 | .5906/.5898   | .6691/.6687    | 2.283 | 0.197 | 1.181 | M17x1   |
| 1.000 / 1.171         | 7833596      | 4.528                | 3.189 | .6693/.6686   | .7872/.7869    | 2.283 | 0.197 | 1.181 | M20x1   |
| 1.150 / 1.250         | 7833597      | 5.039                | 3.504 | .7874/.7866   | .9841/.9837    | 2.480 | 0.197 | 1.260 | M25x1.5 |
| 1.500 x 0.473 & 1.000 | 7833599      | 5.315                | 3.504 | .9843/.9834   | 1.1809/1.18105 | 2.480 | 0.315 | 1.339 | M30x1.5 |
| 1.500 x 0.200 & 0.250 |              |                      |       |               |                |       |       |       |         |
| 1.500 x 0.500 & 1.875 |              |                      |       |               |                |       |       |       |         |
| 1.500 x 2.000         | 7833602      | 5.787                | 3.622 | 1.3780/1.3771 | 1.5746/1.5742  | 2.441 | 0.315 | 1.850 | M40x1.5 |
| 1.750 / 2.000         |              |                      |       |               |                |       |       |       |         |

### Bearing Supports / End Machining - Metric Series Ball Screw

WK Standard End Machining

| Dia x Lead (mm) | Standard P/N | Type WK / WK1 (mm) |      |      |               |      |     |      |         |
|-----------------|--------------|--------------------|------|------|---------------|------|-----|------|---------|
|                 |              | A                  | B    | C    | D             | E    | F   | G    | THD     |
| 25              | 7833614      | 115.0              | 81.0 | 17.0 | 19.995/19.986 | 58.0 | 5.0 | 30.0 | M20x1   |
| 32              | 7833615      | 128.0              | 89.0 | 20.0 | 24.995/24.985 | 63.0 | 5.0 | 32.0 | M25x1.5 |
| 40              | 7833617      | 135.0              | 89.0 | 25.0 | 29.995/29.985 | 63.0 | 8.0 | 34.0 | M30x1.5 |
| 50              | 7833621      | 147.0              | 92.0 | 35.0 | 39.995/39.985 | 62.0 | 8.0 | 47.0 | M40x1.5 |

### Bearing Supports / End Machining - Ball Splines

WK Standard End Machining

| Spline Size (inch) | Standard P/N | Type WK / WK1 (inch) |       |               |               |       |       |       |         |
|--------------------|--------------|----------------------|-------|---------------|---------------|-------|-------|-------|---------|
|                    |              | A                    | B     | C             | D             | E     | F     | G     | THD     |
| 1.000              | 7833596      | 4.528                | 3.189 | .6693/.6686   | .7872/.7869   | 2.283 | 0.197 | 1.181 | M20x1   |
| 1.500              | 7833597      | 5.039                | 3.504 | .7874/.7866   | .9841/.9837   | 2.480 | 0.197 | 1.260 | M25x1.5 |
| 2.000              | 7833602      | 5.787                | 3.622 | 1.3780/1.3771 | 1.5746/1.5742 | 2.441 | 0.315 | 1.850 | M40x1.5 |

## Bearing Supports/End Machining — Ball Screws

QK

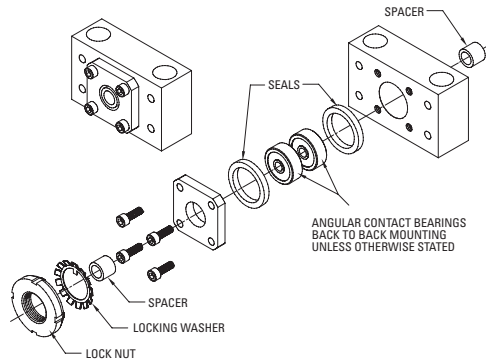

### Bearing Supports / End Machining - Inch Series Ball Screw

QK Bearing Supports

| Standard P/N | Dia. X Lead (inch)  | Bearing Rating      |       |       |                         |       |       | Lock Nut Type | Block Weight (lbs) |
|--------------|---|---------------------|-------|-------|-------------------------|-------|-------|---------------|--------------------|
|              |   | Static Rating $C_0$ |       |       | Dynamic Rating $C_{am}$ |       |       |               |                    |
|              |   | (kgf)               | (lbs) | (N)   | (kgf)                   | (lbs) | (N)   |               |                    |
| 7828282      | 0.500 x 0.200 & 0.500   | 467                 | 1030  | 4550  | 200                     | 440   | 1960  | 5/16-24       | 2.0                |
| 7824154      | 0.631 x 0.200 & 1.000   | 726                 | 1600  | 7100  | 286                     | 630   | 2790  | N-01          | 1.5                |
| 7824155      | 0.750 x 0.200 & 0.500   | 1052                | 2320  | 10300 | 481                     | 1060  | 4700  | N-02          | 3.5                |
| 7824156      | 0.875 x 0.200   | 1452                | 3200  | 14200 | 708                     | 1560  | 6930  | N-03          | 3.5                |
| 7824157      | 1.000 x .200 & 0.250<br>1.000 x 0.500 & 1.000<br>1.171 x 0.413  | 1463                | 3225  | 14300 | 834                     | 1838  | 8150  | N-04          | 5.5                |
| 7824158      | 1.150 x 0.200<br>1.250 x 0.200 & 0.500<br>1.500 x 0.473 & 1.000 | 1701                | 3750  | 16600 | 962                     | 2120  | 9400  | N-05          | 9.5                |
| 7824159      | 1.500 x 0.200 & 0.250<br>1.500 x 0.500 & 1.875<br>1.500 x 2.000 | 2359                | 5200  | 23000 | 1383                    | 3050  | 13500 | N-06          | 11.5               |
| 7829554      | 1.750 x 0.200   | 5171                | 11400 | 50600 | 3084                    | 6800  | 30200 | N-08          | 21.5               |
| 7824160      | 2.000 X 0.200 & 0.500 & 1.000<br>2.250 X 0.500 & 1.000          | 6804                | 15000 | 66600 | 4082                    | 9000  | 39900 | N-09          | 35.0               |
| 7824161      | 2.500 X 0.250 & 0.500 & 1.000                                   | 7847                | 17300 | 76800 | 4899                    | 10800 | 47900 | N-10          | 39.0               |

### Bearing Supports / End Machining - Metric Series Ball Screw

QK Bearing Supports

| Standard P/N | Dia. X Lead (mm) | Bearing Rating      |       |       |                         |       |       | Lock Nut Type | Block Weight (kg) |
|--------------|------------------|---------------------|-------|-------|-------------------------|-------|-------|---------------|-------------------|
|              |                  | Static Rating $C_0$ |       |       | Dynamic Rating $C_{am}$ |       |       |               |                   |
|              |                  | (kgf)               | (lbs) | (N)   | (kgf)                   | (lbs) | (N)   |               |                   |
| 7829546      | 12               | 467                 | 1030  | 4550  | 200                     | 440   | 1960  | M8-1.25       | 0.9               |
| 7829547      | 16               | 726                 | 1600  | 7100  | 286                     | 630   | 2790  | KM-01         | 0.7               |
| 7829548      | 20               | 1052                | 2320  | 10300 | 481                     | 1060  | 4700  | KM-02         | 1.6               |
| 7829549      | 25               | 1463                | 3225  | 14300 | 834                     | 1838  | 8150  | KM-04         | 2.5               |
| 7829550      | 32               | 1701                | 3750  | 16600 | 962                     | 2120  | 9400  | KM-05         | 4.3               |
| 7829551      | 40               | 2359                | 5200  | 23000 | 1383                    | 3050  | 13500 | KM-06         | 5.2               |
| 7829552      | 50               | 5171                | 11400 | 50600 | 3084                    | 6800  | 30200 | KM-08         | 9.8               |
| 7829553      | 63               | 7847                | 17300 | 76800 | 4899                    | 10800 | 47900 | KM-10         | 17.7              |

### Bearing Supports / End Machining - Ball Splines

QK Bearing Supports

| Standard P/N | Spline Size (inch) | Bearing Rating      |       |       |                         |       |       | Lock Nut Type | Block Weight (lbs) |
|--------------|--------------------|---------------------|-------|-------|-------------------------|-------|-------|---------------|--------------------|
|              |                    | Static Rating $C_0$ |       |       | Dynamic Rating $C_{am}$ |       |       |               |                    |
|              |                    | (kgf)               | (lbs) | (N)   | (kgf)                   | (lbs) | (N)   |               |                    |
| 7828282      | 0.625              | 467                 | 1030  | 4550  | 200                     | 440   | 1960  | 5/16-24       | 2.0                |
| 7824157      | 1.000              | 1463                | 3225  | 14300 | 834                     | 1838  | 8150  | N-04          | 5.5                |
| 7824159      | 1.500              | 2359                | 5200  | 23000 | 1383                    | 3050  | 13500 | N-06          | 11.5               |
| 7829554      | 2.000              | 5171                | 11400 | 50600 | 3084                    | 6800  | 30200 | N-08          | 21.5               |
| 7824161      | 2.500              | 7847                | 17300 | 76800 | 4899                    | 10800 | 47900 | N-10          | 39.0               |

## Bearing Supports/End Machining — Ball Screws

QK

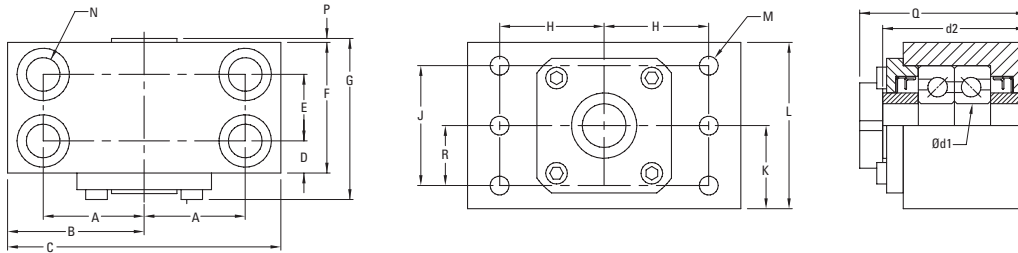

### Bearing Supports / End Machining - Inch Series Ball Screw

QK Bearing Supports

| Standard P/N | Bearing Block Dimensions (inch) |       |       |       |       |       |       |       |       |       |       |       |             |                                       |      |     |       |
|--------------|---------------------------------|-------|-------|-------|-------|-------|-------|-------|-------|-------|-------|-------|-------------|---------------------------------------|------|-----|-------|
|              | d1 (mm)                         | d2    | A & H | B     | C     | D     | E     | F     | G     | J     | K     | L     | M           | N                                     | P    | Q   | R     |
| 7828282      | 9                               | 1.530 | 1.000 | 1.380 | 2.750 | 0.630 | -     | 1.190 | 1.645 | 1.375 | 1.000 | 2.000 | 4x .281 dia | 2x .281 Thru, .50 C-Bore x .56 Dp     | -    | 1.8 | 0.688 |
| 7824154      | 12                              | 1.260 | 1.125 | 1.500 | 3.000 | 0.670 | -     | 1.340 | 1.700 | 1.125 | 1.000 | 1.880 | 4x .281 dia | 2x .406 Thru, .625 C-Bore x .875 Dp   | 0.02 | 1.6 | 0.625 |
| 7824155      | 15                              | 1.730 | 1.250 | 1.750 | 3.500 | 0.750 | -     | 1.500 | 1.900 | 1.375 | 1.125 | 2.130 | 4x .281 dia | 2x .406 Thru, .625 C-Bore x .875 Dp   | 0.02 | 2.1 | 0.750 |
| 7824156      | 17                              | 1.890 | 1.437 | 2.000 | 4.000 | 0.830 | -     | 1.660 | 2.000 | 1.375 | 1.250 | 2.380 | 4x .406 dia | 2x .531 Thru, .812 C-Bore x 1.125 Dp  | 0.02 | 2.3 | 0.750 |
| 7824157      | 20                              | 2.200 | 1.625 | 2.250 | 4.500 | 0.940 | -     | 1.870 | 2.400 | 1.750 | 1.438 | 2.750 | 4x .469 dia | 2x .656 Thru, 1.00 C-Bore x 1.312 Dp  | 0.04 | 2.7 | 0.938 |
| 7824158      | 25                              | 2.360 | 2.125 | 3.000 | 6.000 | 0.970 | -     | 1.940 | 2.600 | 2.000 | 1.750 | 3.380 | 4x .656 dia | 2x .906 Thru, 1.375 C-Bore x 2.00 Dp  | 0.03 | 2.9 | 1.000 |
| 7824159      | 30                              | 2.520 | 2.375 | 3.250 | 6.500 | 1.030 | -     | 2.060 | 2.700 | 2.000 | 1.875 | 3.630 | 4x .656 dia | 2x .906 Thru, 1.375 C-Bore x 2.062 Dp | 0.05 | 3   | 1.000 |
| 7829554      | 40                              | 3.620 | 2.937 | 3.750 | 7.500 | 0.760 | 1.630 | 3.150 | 3.800 | 3.000 | 2.250 | 4.250 | 6x .656 dia | 4x .906 Thru, 1.375 C-Bore x 2.25 Dp  | 0.05 | 4.2 | 1.500 |
| 7824160      | 45                              | 3.940 | 3.313 | 4.250 | 8.500 | 0.870 | 1.720 | 3.470 | 4.200 | 3.625 | 2.813 | 5.630 | 6x .812 dia | 4x 1.031 Thru, 1.625 C-Bore x 3.50 Dp | 0.05 | 4.5 | 1.813 |
| 7824161      | 50                              | 4.250 | 3.563 | 4.500 | 9.000 | 0.920 | 1.720 | 3.560 | 4.500 | 3.625 | 2.813 | 5.630 | 6x .812 dia | 4x 1.031 Thru, 1.625 C-Bore x 3.50 Dp | 0.05 | 4.9 | 1.813 |

### Bearing Supports / End Machining - Metric Series Ball Screw

QK Bearing Supports

| Standard P/N | Bearing Block Dimensions (mm) |       |       |       |       |      |      |      |       |      |       |       |              |  |      |        |      |
|--------------|-------------------------------|-------|-------|-------|-------|------|------|------|-------|------|-------|-------|--------------|--|------|--------|------|
|              | d1 (mm)                       | d2    | A & H | B     | C     | D    | E    | F    | G     | J    | K     | L     | M            | N                                      | P    | Q      | R    |
| 7829546      | 9                             | 37.0  | 25.4  | 35.0  | 70.0  | 16.0 | -    | 30.2 | 35.0  | 35.0 | 25.40 | 50.8  | 4x 7.13 dia  | 2x 7.13 Thru, 12.7 C-Bore x 14.22 Dp   | -    | 46.25  | 17.5 |
| 7829547      | 12                            | 32.0  | 28.6  | 38.0  | 76.0  | 17.0 | -    | 34.0 | 43.0  | 29.0 | 25.40 | 47.8  | 4x 7.13 dia  | 2x 10.31 Thru, 15.88 C-Bore x 22.23 Dp | 0.51 | 40.64  | 15.9 |
| 7829548      | 15                            | 44.0  | 31.8  | 45.0  | 89.0  | 19.0 | -    | 38.0 | 47.0  | 35.0 | 28.58 | 54.1  | 4x 7.13 dia  | 2x 10.31 Thru, 15.88 C-Bore x 25.40 Dp | 0.51 | 53.34  | 19.1 |
| 7829549      | 20                            | 56.0  | 41.3  | 57.0  | 114.0 | 24.0 | -    | 48.0 | 60.0  | 44.0 | 36.53 | 69.9  | 4x 11.91 dia | 2x 16.66 Thru, 25.40 C-Bore x 33.33 Dp | 1    | 68.58  | 23.8 |
| 7829550      | 25                            | 60.0  | 54.0  | 76.0  | 152.0 | 24.5 | -    | 49.0 | 65.0  | 51.0 | 44.45 | 85.9  | 4x 16.66 dia | 2x 23.01 Thru, 34.93 C-Bore x 50.80 Dp | 0.76 | 73.66  | 25.4 |
| 7829551      | 30                            | 64.0  | 60.3  | 83.0  | 165.0 | 26.0 | -    | 52.0 | 68.0  | 51.0 | 47.63 | 92.2  | 4x 6.66 dia  | 2x 23.01 Thru, 34.93 C-Bore x 52.38 Dp | 1.14 | 76.2   | 25.4 |
| 7829552      | 40                            | 92.0  | 74.6  | 96.0  | 192.0 | 19.2 | 41.5 | 80.0 | 96.0  | 76.0 | 57.15 | 108.0 | 6x 16.66 dia | 4x 23.01 Thru, 34.93 C-Bore x 57.15 Dp | 1.27 | 106.68 | 38.1 |
| 7829553      | 50                            | 108.0 | 90.5  | 115.0 | 230.0 | 23.5 | 43.8 | 90.8 | 113.0 | 92.0 | 71.45 | 143.0 | 6x 20.63 dia | 4x 26.19 Thru, 41.28 C-Bore x 88.90 Dp | 2.29 | 124.46 | 46.1 |

### Bearing Supports / End Machining - Ball Splines

QK Bearing Supports

| Standard P/N | Bearing Block Dimensions (inch) |       |       |       |       |       |       |       |       |       |       |       |             |                                       |      |     |       |
|--------------|---------------------------------|-------|-------|-------|-------|-------|-------|-------|-------|-------|-------|-------|-------------|---------------------------------------|------|-----|-------|
|              | d1 (mm)                         | d2    | A & H | B     | C     | D     | E     | F     | G     | J     | K     | L     | M           | N                                     | P    | Q   | R     |
| 7828282      | 9                               | 1.440 | 1.000 | 1.380 | 2.750 | 0.630 | -     | 1.190 | 1.400 | 1.375 | 1.000 | 2.000 | 4x .281 dia | 2x .281 Thru, .50 C-Bore x .56 Dp     | -    | 1.8 | 0.688 |
| 7824157      | 20                              | 2.200 | 1.625 | 2.250 | 4.500 | 0.940 | -     | 1.870 | 2.400 | 1.750 | 1.438 | 2.750 | 4x .469 dia | 2x .656 Thru, 1.00 C-Bore x 1.312 Dp  | 0.04 | 2.7 | 0.938 |
| 7824159      | 30                              | 2.520 | 2.375 | 3.250 | 6.500 | 1.030 | -     | 2.060 | 2.700 | 2.000 | 1.875 | 3.630 | 4x .656 dia | 2x .906 Thru, 1.375 C-Bore x 2.062 Dp | 0.05 | 3   | 1.000 |
| 7829554      | 40                              | 3.620 | 2.937 | 3.750 | 7.500 | 0.760 | 1.630 | 3.150 | 3.800 | 3.000 | 2.250 | 4.250 | 6x .656 dia | 4x .906 Thru, 1.375 C-Bore x 2.25 Dp  | 0.05 | 4.2 | 1.500 |
| 7824161      | 50                              | 4.250 | 3.563 | 4.500 | 9.000 | 0.920 | 1.720 | 3.560 | 4.500 | 3.625 | 2.813 | 5.630 | 6x .812 dia | 4x 1.031 Thru, 1.625 C-Bore x 3.50 Dp | 0.05 | 4.9 | 1.813 |

## Bearing Supports/End Machining — Ball Screws

QF

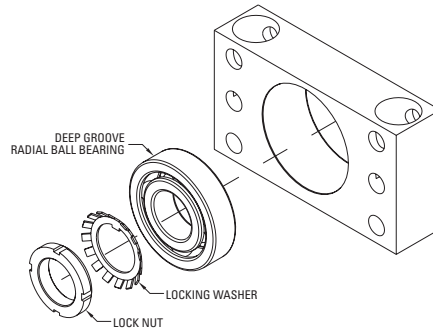

### Bearing Supports / End Machining - Inch Series Ball Screw

QF Bearing Supports

| Standard P/N | Dia. X Lead (inch)  | Lock Nut Type | Block Weight (lbs) |
|--------------|---|---------------|--------------------|
| 7833291      | 0.500 x 0.200 & 0.500   | 5/16-24       | 0.8                |
| 7833256      | 0.631 x 0.200 & 1.000   | N-01          | 1.3                |
| 7833259      | 0.750 x 0.200 & 0.500   | N-02          | 1.6                |
| 7833262      | 0.875 x 0.200   | N-03          | 2.3                |
| 7833265      | 1.000 x .200 & 0.250<br>1.000 x 0.500 & 1.000<br>1.171 x 0.413  | N-04          | 5.8                |
| 7833268      | 1.150 x 0.200<br>1.250 x 0.200 & 0.500<br>1.500 x 0.473 & 1.000 | N-05          | 6.8                |
| 7833270      | 1.500 x 0.200 & 0.250<br>1.500 x 0.500 & 1.875<br>1.500 x 2.000 | N-06          | 8.7                |
| 7833273      | 1.750 x 0.200   | N-08          | 9.7                |
| 7833276      | 2.000 X 0.200 & 0.500 & 1.000<br>2.250 X 0.500 & 1.000          | N-09          | 16.2               |
| 7833279      | 2.500 X 0.250 & 0.500 & 1.000                                   | N-10          | 18.5               |

### Bearing Supports / End Machining - Metric Series Ball Screw

QF Bearing Supports

| Standard P/N | Dia. X Lead (mm) | Lock Nut Type | Block Weight (kg) |
|--------------|------------------|---------------|-------------------|
| 7833292      | 12               | M8-1.25       | 0.2               |
| 7833282      | 16               | KM-01         | 0.3               |
| 7833283      | 20               | KM-02         | 0.3               |
| 7833284      | 25               | KM-03         | 1.2               |
| 7833285      | 32               | KM-05         | 1.4               |
| 7833286      | 40               | KM-06         | 1.8               |
| 7833287      | 50               | KM-08         | 2.0               |
| 7833288      | 63               | KM-10         | 3.8               |

### Bearing Supports / End Machining - Ball Splines

QF Bearing Supports

| Standard P/N | Spline Size (inch) | Lock Nut Type | Block Weight (lbs) |
|--------------|--------------------|---------------|--------------------|
| 7833291      | 0.625              | 5/16-24       | 0.8                |
| 7833265      | 1.000              | N-04          | 5.8                |
| 7833270      | 1.500              | N-06          | 8.7                |
| 7833273      | 2.000              | N-08          | 9.7                |
| 7833279      | 2.500              | N-10          | 18.5               |

## Bearing Supports/End Machining — Ball Screws

QF

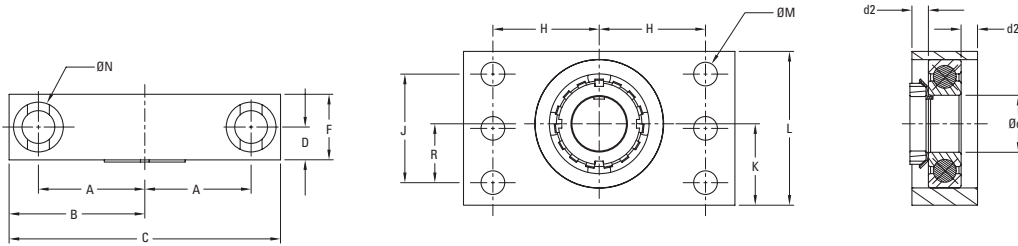

### Bearing Supports / End Machining - Inch Series Ball Screw

QF Bearing Supports

| Standard P/N | Bearing Block Dimensions (inch) |       |       |       |       |       |       |       |       |       |             |                                       |       | Q     | R |
|--------------|---------------------------------|-------|-------|-------|-------|-------|-------|-------|-------|-------|-------------|---------------------------------------|-------|-------|---|
|              | d1 (mm)                         | d2    | A & H | B     | C     | D     | F     | J     | K     | L     | M           | N                                     |       |       |   |
| 7833291      | 9                               | 0.118 | 1.000 | 1.380 | 2.750 | 0.276 | 0.551 | 1.375 | 1.000 | 2.000 | 4x .281 dia | 2x .281 Thru, .50 C-Bore x .56 Dp     | 0.757 | 0.688 |   |
| 7833256      | 12                              | 0.197 | 1.125 | 1.500 | 3.000 | 0.394 | 0.787 | 1.125 | 1.000 | 1.880 | 4x .281 dia | 2x .406 Thru, .625 C-Bore x .875 Dp   | 0.96  | 0.625 |   |
| 7833259      | 15                              | 0.217 | 1.250 | 1.750 | 3.500 | 0.433 | 0.866 | 1.375 | 1.125 | 2.130 | 4x .281 dia | 2x .406 Thru, .625 C-Bore x .875 Dp   | 1.019 | 0.750 |   |
| 7833262      | 17                              | 0.236 | 1.437 | 2.000 | 4.000 | 0.473 | 0.945 | 1.375 | 1.250 | 2.380 | 4x .406 dia | 2x .531 Thru, .812 C-Bore x 1.125 Dp  | 1.109 | 0.750 |   |
| 7833265      | 20                              | 0.276 | 1.625 | 2.250 | 4.500 | 0.551 | 1.102 | 1.750 | 1.438 | 2.750 | 4x .469 dia | 2x .656 Thru, 1.00 C-Bore x 1.312 Dp  | 1.258 | 0.938 |   |
| 7833268      | 25                              | 0.531 | 2.125 | 3.000 | 6.000 | 0.827 | 1.654 | 2.000 | 1.750 | 3.380 | 4x .656 dia | 2x .906 Thru, 1.375 C-Bore x 2.00 Dp  | 1.654 | 1.000 |   |
| 7833270      | 30                              | 0.512 | 2.375 | 3.250 | 6.500 | 0.827 | 1.654 | 2.000 | 1.875 | 3.630 | 4x .656 dia | 2x .906 Thru, 1.375 C-Bore x 2.062 Dp | 1.654 | 1.000 |   |
| 7833273      | 40                              | 0.453 | 2.937 | 3.750 | 7.500 | 0.906 | 1.811 | 3.000 | 2.250 | 4.250 | 6x .656 dia | 4x .906 Thru, 1.375 C-Bore x 2.25 Dp  | 1.869 | 1.500 |   |
| 7833276      | 45                              | 0.492 | 3.313 | 4.250 | 8.500 | 0.985 | 1.969 | 3.625 | 2.813 | 5.630 | 6x .812 dia | 4x 1.031 Thru, 1.625 C-Bore x 3.50 Dp | 1.987 | 1.813 |   |
| 7833279      | 50                              | 0.531 | 3.563 | 4.500 | 9.000 | 1.063 | 2.126 | 3.625 | 2.813 | 5.630 | 6x .812 dia | 4x 1.031 Thru, 1.625 C-Bore x 3.50 Dp | 2.167 | 1.813 |   |

### Bearing Supports / End Machining - Metric Series Ball Screw

QF Bearing Supports

| Standard P/N | Bearing Block Dimensions (mm) |      |       |       |       |      |      |      |       |       |              |  |      | Q    | R |
|--------------|-------------------------------|------|-------|-------|-------|------|------|------|-------|-------|--------------|--|------|------|---|
|              | d1 (mm)                       | d2   | A & H | B     | C     | D    | F    | J    | K     | L     | M            | N                                      |      |      |   |
| 7833292      | 9                             | 3.0  | 25.4  | 35.0  | 70.0  | 7.0  | 14.0 | 35.0 | 25.40 | 50.8  | 4x 7.13 dia  | 2x 7.13 Thru, 12.7 C-Bore x 14.22 Dp   | 18.5 | 17.5 |   |
| 7833282      | 12                            | 5.0  | 28.6  | 38.0  | 76.0  | 10.0 | 20.0 | 29.0 | 25.40 | 47.8  | 4x 7.13 dia  | 2x 10.31 Thru, 15.88 C-Bore x 22.23 Dp | 20   | 15.9 |   |
| 7833283      | 15                            | 5.5  | 31.8  | 45.0  | 89.0  | 11.0 | 22.0 | 35.0 | 28.58 | 54.1  | 4x 7.13 dia  | 2x 10.31 Thru, 15.88 C-Bore x 25.40 Dp | 22   | 19.1 |   |
| 7833284      | 20                            | 7.0  | 41.3  | 57.0  | 114.0 | 14.0 | 28.0 | 44.0 | 36.53 | 69.9  | 4x 11.91 dia | 2x 16.66 Thru, 25.40 C-Bore x 33.33 Dp | 28   | 23.8 |   |
| 7833285      | 25                            | 13.5 | 54.0  | 76.0  | 152.0 | 21.0 | 42.0 | 51.0 | 44.45 | 85.9  | 4x 16.66 dia | 2x 23.01 Thru, 34.93 C-Bore x 50.80 Dp | 42   | 25.4 |   |
| 7833286      | 30                            | 13.0 | 60.3  | 83.0  | 165.0 | 21.0 | 42.0 | 51.0 | 47.63 | 92.2  | 4x 6.66 dia  | 2x 23.01 Thru, 34.93 C-Bore x 52.38 Dp | 42   | 25.4 |   |
| 7833287      | 40                            | 11.5 | 74.6  | 96.0  | 192.0 | 23.0 | 46.0 | 76.0 | 57.15 | 108.0 | 6x 16.66 dia | 4x 23.01 Thru, 34.93 C-Bore x 57.15 Dp | 46   | 38.1 |   |
| 7833288      | 50                            | 13.5 | 90.5  | 115.0 | 230.0 | 27.0 | 54.0 | 92.0 | 71.45 | 143.0 | 6x 20.63 dia | 4x 26.19 Thru, 41.28 C-Bore x 88.90 Dp | 54   | 46.1 |   |

### Bearing Supports / End Machining - Ball Splines

QF Bearing Supports

| Standard P/N | Bearing Block Dimensions (inch) |       |       |       |       |       |       |       |       |       |             |                                       |       | Q     | R |
|--------------|---------------------------------|-------|-------|-------|-------|-------|-------|-------|-------|-------|-------------|---------------------------------------|-------|-------|---|
|              | d1 (mm)                         | d2    | A & H | B     | C     | D     | F     | J     | K     | L     | M           | N                                     |       |       |   |
| 7833291      | 9                               | 0.118 | 1.000 | 1.380 | 2.750 | 0.276 | 0.551 | 1.375 | 1.000 | 2.000 | 4x .281 dia | 2x .281 Thru, .50 C-Bore x .56 Dp     | 0.757 | 0.688 |   |
| 7833265      | 20                              | 0.276 | 1.625 | 2.250 | 4.500 | 0.551 | 1.102 | 1.750 | 1.438 | 2.750 | 4x .469 dia | 2x .656 Thru, 1.00 C-Bore x 1.312 Dp  | 1.258 | 0.938 |   |
| 7833270      | 30                              | 0.512 | 2.375 | 3.250 | 6.500 | 0.827 | 1.654 | 2.000 | 1.875 | 3.630 | 4x .656 dia | 2x .906 Thru, 1.375 C-Bore x 2.062 Dp | 1.654 | 1.000 |   |
| 7833273      | 40                              | 0.453 | 2.937 | 3.750 | 7.500 | 0.906 | 1.811 | 3.000 | 2.250 | 4.250 | 6x .656 dia | 4x .906 Thru, 1.375 C-Bore x 2.25 Dp  | 1.869 | 1.500 |   |
| 7833279      | 50                              | 0.531 | 3.563 | 4.500 | 9.000 | 1.063 | 2.126 | 3.625 | 2.813 | 5.630 | 6x .812 dia | 4x 1.031 Thru, 1.625 C-Bore x 3.50 Dp | 2.167 | 1.813 |   |

## Bearing Supports/End Machining — Ball Screws

QK

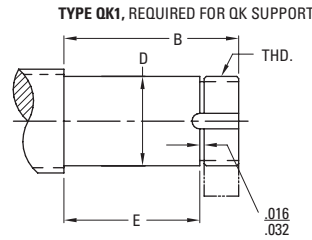
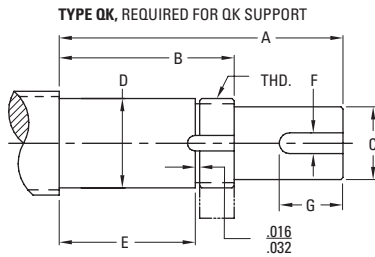

### Bearing Supports / End Machining - Inch Series Ball Screw

QK Standard End Machining

| Dia x Lead (inch)             | Standard P/N | Type QK / QK1 (inch) |       |               |               |       |       |       |         | Bearing Trade No. |
|-------------------------------|--------------|----------------------|-------|---------------|---------------|-------|-------|-------|---------|-------------------|
|                               |              | A                    | B     | C             | D             | E     | F     | G     | THD     |                   |
| 0.500 x 0.200 & 0.500         | 7828282      | 2.915                | 1.665 | .2500/.2490   | .3544/.3541   | 1.260 | 0.094 | 1.000 | 5/16-24 | 609               |
| 0.631 x 0.200 & 1.000         | 7824154      | 3.292                | 1.992 | .4060/.4050   | .4726/.4723   | 1.576 | 0.125 | 1.250 | N-01    | 7201              |
| 0.750 x 0.200 & 0.500         | 7824155      | 3.180                | 2.180 | .5000/.4990   | .5908/.5905   | 1.732 | 0.125 | 0.875 | N-02    | 7202              |
| 0.875 x 0.200                 | 7824156      | 3.649                | 2.334 | .5620/.5610   | .6695/.6692   | 1.888 | 0.125 | 1.250 | N-03    | 7203              |
| 1.000 x .200 & 0.250          | 7824157      | 4.028                | 2.713 | .6250/.6240   | .7877/.7873   | 2.204 | 0.188 | 1.250 | N-04    | 7204              |
| 1.000 x 0.500 & 1.000         |              |                      |       |               |               |       |       |       |         |                   |
| 1.171 x 0.413                 |              |                      |       |               |               |       |       |       |         |                   |
| 1.150 x 0.200                 | 7824158      | 4.453                | 2.893 | .7500/.7490   | .9846/.9842   | 2.364 | 0.188 | 1.250 | N-05    | 7205              |
| 1.250 x 0.200 & 0.500         |              |                      |       |               |               |       |       |       |         |                   |
| 1.500 x 0.473 & 1.000         |              |                      |       |               |               |       |       |       |         |                   |
| 1.500 x 0.200 & 0.250         | 7824159      | 4.860                | 3.050 | 1.000/.9990   | 1.1814/1.1810 | 2.520 | 0.250 | 1.250 | N-06    | 7206              |
| 1.500 x 0.500 & 1.875         |              |                      |       |               |               |       |       |       |         |                   |
| 1.500 x 2.000                 |              |                      |       |               |               |       |       |       |         |                   |
| 1.750 x 0.200                 | 7829554      | 6.368                | 4.178 | 1.3750/1.3740 | 1.5752/1.5747 | 3.624 | 0.313 | 1.875 | N-08    | 7308              |
| 2.000 x 0.200 & 0.500 & 1.000 | 7824160      | 6.682                | 4.492 | 1.3750/1.3740 | 1.7721/1.7716 | 3.936 | 0.313 | 1.875 | N-09    | 7309              |
| 2.250 x 0.500                 |              |                      |       |               |               |       |       |       |         |                   |
| 2.250 x 1.000                 |              |                      |       |               |               |       |       |       |         |                   |
| 2.500 x 0.250                 | 7824161      | 7.749                | 4.872 | 1.7500/1.7490 | 1.9689/1.9684 | 4.252 | 0.375 | 2.750 | N-10    | 7310              |
| 2.500 x 0.500                 |              |                      |       |               |               |       |       |       |         |                   |
| 2.500 x 1.000                 |              |                      |       |               |               |       |       |       |         |                   |

### Bearing Supports / End Machining - Metric Series Ball Screw

QK Standard End Machining

| Dia x Lead (mm) | Standard P/N | Type QK / QK1 (mm) |       |               |               |       |      |      |         | Bearing Trade No. |
|-----------------|--------------|--------------------|-------|---------------|---------------|-------|------|------|---------|-------------------|
|                 |              | A                  | B     | C             | D             | E     | F    | G    | THD     |                   |
| 12              | 7829546      | 73.0               | 46.0  | 6.000/5.987   | 9.001/8.994   | 36.0  | -    | -    | M8-1.25 | 609               |
| 16              | 7829547      | 84.0               | 51.0  | 10.000/9.987  | 12.006/11.999 | 40.0  | 3.0  | 30.0 | KM-01   | 7201              |
| 20              | 7829548      | 80.0               | 55.0  | 12.000/11.984 | 15.006/14.999 | 44.0  | 4.0  | 22.0 | KM-02   | 7202              |
| 25              | 7829549      | 103.0              | 69.0  | 16.000/15.984 | 20.007/19.997 | 56.0  | 5.0  | 30.0 | KM-04   | 7204              |
| 32              | 7829550      | 113.0              | 74.0  | 20.000/19.980 | 25.008/24.996 | 60.0  | 5.0  | 32.0 | KM-05   | 7205              |
| 40              | 7829551      | 124.0              | 78.0  | 25.000/24.980 | 30.007/29.997 | 64.0  | 8.0  | 34.0 | KM-06   | 7206              |
| 50              | 7829552      | 164.0              | 109.0 | 32.000/31.976 | 40.010/39.997 | 92.0  | 8.0  | 47.0 | KM-08   | 7308              |
| 63              | 7829553      | 197.0              | 124.0 | 40.000/39.977 | 50.010/49.997 | 108.0 | 10.0 | 65.0 | KM-10   | 7310              |

### Bearing Supports / End Machining - Ball Splines

QK Standard End Machining

| Spline Size (inch) | Standard P/N | Type QK / QK1 (inch) |       |               |               |       |       |       |         | Bearing Trade No. |
|--------------------|--------------|----------------------|-------|---------------|---------------|-------|-------|-------|---------|-------------------|
|                    |              | A                    | B     | C             | D             | E     | F     | G     | THD     |                   |
| 0.625              | 7828282      | 2.915                | 1.665 | .2500/.2490   | .3544/.3541   | 1.260 | 0.094 | 1.000 | 5/16-24 | 609               |
| 1.000              | 7824157      | 4.028                | 2.713 | .6250/.6240   | .7877/.7873   | 2.204 | 0.188 | 1.250 | N-04    | 7204              |
| 1.500              | 7824159      | 4.860                | 3.050 | 1.000/.9990   | 1.1814/1.1810 | 2.520 | 0.250 | 1.250 | N-06    | 7206              |
| 2.000              | 7829554      | 6.368                | 4.178 | 1.3750/1.3740 | 1.5752/1.5747 | 3.624 | 0.313 | 1.875 | N-08    | 7308              |
| 2.500              | 7824161      | 7.749                | 4.872 | 1.7500/1.7490 | 1.9689/1.9684 | 4.252 | 0.375 | 2.750 | N-10    | 7310              |



## Bearing Supports/End Machining — Ball Screws

QF

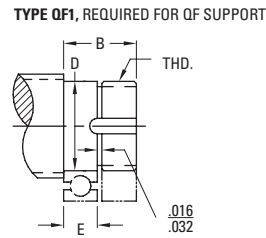
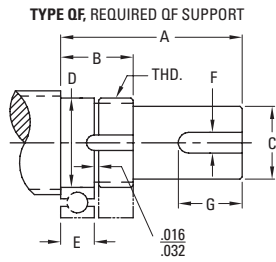

### Bearing Supports / End Machining - Inch Series Ball Screw

QF Standard End Machining

| Standard P/N | Type QF / QF1 (inch) |       |               |               |       |       |       |         | Bearing Trade No. |
|--------------|----------------------|-------|---------------|---------------|-------|-------|-------|---------|-------------------|
|              | A                    | B     | C             | D             | E     | F     | G     | THD     |                   |
| 7833291      | 1.970                | 0.720 | .2500/.2490   | .3544/.3541   | 0.315 | 0.094 | 1.000 | 5/16-24 | 609               |
| 7833256      | 2.110                | 0.810 | .4060/.4050   | .4726/.4723   | 0.394 | 0.125 | 1.250 | N-01    | 6201              |
| 7833259      | 1.870                | 0.870 | .5000/.4990   | .5908/.5905   | 0.433 | 0.125 | 0.875 | N-02    | 6202              |
| 7833262      | 2.233                | 0.918 | .5620/.5610   | .6695/.6692   | 0.472 | 0.125 | 1.250 | N-03    | 6203              |
| 7833265      | 2.375                | 1.060 | .6250/.6240   | .7877/.7873   | 0.551 | 0.188 | 1.250 | N-04    | 6204              |
| 7833268      | 2.680                | 1.120 | .7500/.7490   | .9846/.9842   | 0.591 | 0.188 | 1.250 | N-05    | 6205              |
| 7833270      | 2.970                | 1.160 | 1.0000/.9990  | 1.1814/1.1810 | 0.630 | 0.250 | 1.250 | N-06    | 6206              |
| 7833273      | 3.650                | 1.460 | 1.3750/1.3740 | 1.5752/1.5747 | 0.906 | 0.313 | 1.875 | N-08    | 6308              |
| 7833276      | 3.730                | 1.540 | 1.3750/1.3740 | 1.7721/1.7716 | 0.984 | 0.313 | 1.875 | N-09    | 6309              |
| 7833279      | 4.560                | 1.680 | 1.7500/1.7490 | 1.9689/1.9684 | 1.063 | 0.375 | 2.750 | N-10    | 6310              |

### Bearing Supports / End Machining - Metric Series Ball Screw

QF Standard End Machining

| Standard P/N | Type QF / QF1 (mm) |      |               |               |      |      |      |         | Bearing Trade No. |
|--------------|--------------------|------|---------------|---------------|------|------|------|---------|-------------------|
|              | A                  | B    | C             | D             | E    | F    | G    | THD     |                   |
| 7833292      | 46.0               | 19.0 | 6.000/5.987   | 9.001/8.994   | 7.0  | -    | -    | M8-1.25 | 609               |
| 7833282      | 54.0               | 21.0 | 10.000/9.987  | 12.006/11.999 | 10.0 | 3.0  | 30.0 | KM-01   | 6201              |
| 7833283      | 47.0               | 22.0 | 12.000/11.984 | 15.006/14.999 | 11.0 | 4.0  | 22.0 | KM-02   | 6202              |
| 7833284      | 61.0               | 27.0 | 16.000/15.984 | 20.007/19.997 | 14.0 | 5.0  | 30.0 | KM-04   | 6204              |
| 7833285      | 68.0               | 29.0 | 20.000/19.980 | 25.008/24.996 | 15.0 | 5.0  | 32.0 | KM-05   | 6205              |
| 7833286      | 76.0               | 30.0 | 25.000/24.980 | 30.007/29.997 | 16.0 | 8.0  | 34.0 | KM-06   | 6206              |
| 7833287      | 95.0               | 40.0 | 32.000/31.976 | 40.010/39.997 | 23.0 | 8.0  | 47.0 | KM-08   | 6308              |
| 7833288      | 116.0              | 43.0 | 40.000/39.977 | 50.010/49.997 | 27.0 | 10.0 | 65.0 | KM-10   | 6310              |

### Bearing Supports / End Machining - Ball Splines

QF Standard End Machining

| Standard P/N | Type QF / QF1 (inch) |       |               |               |       |       |       |         | Bearing Trade No. |
|--------------|----------------------|-------|---------------|---------------|-------|-------|-------|---------|-------------------|
|              | A                    | B     | C             | D             | E     | F     | G     | THD     |                   |
| 7833291      | 1.970                | 0.720 | .2500/.2490   | .3544/.3541   | 0.315 | 0.094 | 1.000 | 5/16-24 | 609               |
| 7833265      | 2.375                | 1.060 | .6250/.6240   | .7877/.7873   | 0.551 | 0.188 | 1.250 | N-04    | 6204              |
| 7833270      | 2.970                | 1.160 | 1.0000/.9990  | 1.1814/1.1810 | 0.630 | 0.250 | 1.250 | N-06    | 6206              |
| 7833273      | 3.650                | 1.460 | 1.3750/1.3740 | 1.5752/1.5747 | 0.906 | 0.313 | 1.875 | N-08    | 6308              |
| 7833279      | 4.560                | 1.680 | 1.7500/1.7490 | 1.9689/1.9684 | 1.063 | 0.375 | 2.750 | N-10    | 6310              |

**NOTES:**

A large grid of graph paper for taking notes, consisting of 30 columns and 40 rows of small squares.

# Engineering



## Table of Contents

| <b>Description</b>                | <b>Page</b> |
|-----------------------------------|-------------|
| Lead Screws .....                 | 181         |
| Ball Screws — Inch Series .....   | 189         |
| Ball Screws — Metric Series ..... | 203         |
| Ball Splines .....                | 213         |
| Installation.....                 | 217         |
| Maintenance and Service.....      | 227         |
| Lubrication .....                 | 233         |
| Glossary/Formulas.....            | 233         |

Need a quote or have a question about an application? Contact us in North America at:

Phone: 540-633-3400

Fax: 540-639-4162

Email: [thomson@thomsonlinear.com](mailto:thomson@thomsonlinear.com)



**NOTES:**

A large rectangular area filled with a light gray grid, intended for handwritten notes. The grid consists of approximately 30 columns and 40 rows of small squares.

## Lead Screws — Engineering



Need a quote or have a question about an application? Contact us in North America at:

Phone: 800-882-8857

Email: [thomsonbsa@thomsonlinear.com](mailto:thomsonbsa@thomsonlinear.com)

Web: [www.thomsonbsa.com](http://www.thomsonbsa.com)

# Lead Screws Engineering Overview

## Precision Lead Screws & Supernuts®

### Features/Advantages

#### Low Cost

Considerable savings when compared to ball screw assemblies.

#### Variety

Largest range of leads and diameters 3/16" to 3" to match your requirements.

#### Lubrication

Internally lubricated plastic nuts will operate without lubrication. However, additional lubrication or PTFE coating of the screw is recommended to optimize efficiency and life. See page 233.

#### Vibration and Noise

No ball recirculating vibration and often less audible noise compared to ball screws.

### Design Considerations

#### Load

Supernuts provide a cost effective solution for moderate to light loads. For vertical applications, anti backlash supernuts should be mounted with thread/flange on the bottom.

#### Cantilevered Loads

Cantilevered loads that might cause a moment on the nut will cause premature failure.

#### Column Loading

Refer to column loading chart on page 212.

#### Critical Speed

Refer to critical speed chart on page 211.

#### Self-Locking

Lead screws can be self locking at low leads. Generally, the lead of the screw should be more than 1/3 of the diameter to satisfactorily backdrive.

#### Custom

Option of custom designs to fit into your design envelope.

#### Non-Corrosive\*

Stainless Steel and internally lubricated acetal.

#### Environment

Less susceptible to particulate contamination compared to ball screws.

#### Lightweight

Less mass to move.

#### Temperature

Ambient and friction generated heat are the primary causes of premature plastic nut failure. Observe the temperature limits below and discuss your design with our application engineers for continuous duty, high load and high speed applications. Thomson BSA recommends bronze nuts for very high temperature environments or can aid in your selection of high temperature plastic for a custom assembly.

#### Efficiency

Except at very high leads, efficiency increases as lead increases. Although the internally lubricated acetal provides excellent lubricity, Ball Screw Assemblies remain significantly more efficient than any Acme design.

#### Length Limitations

|               |     |
|---------------|-----|
| 3/16" to 1/4" | 3'  |
| 5/16" to 10mm | 4'  |
| 7/16" to 5/8" | 6'  |
| >5/8"         | 12' |

#### Lead Accuracy

|                       |            |
|-----------------------|------------|
| Standard Grade (SRA)  | .010 in/ft |
| Precision Grade (SPR) | .003 in/ft |

| Assembly            |                      | Screws           |                  | Nuts**           |                             |                                   |
|---------------------|----------------------|------------------|------------------|------------------|-----------------------------|-----------------------------------|
| Maximum Temperature | Friction Coefficient | Material         | Material         | Tensile Strength | Water Absorption (24 HRS %) | Thermal Expansion Coefficient     |
| 180°F               | 0.08 – 0.14          | Stainless Steel* | Acetal with PTFE | 8,000 psi        | 0.15                        | 5.4 x 10 <sup>-5</sup> in./in./°F |

\* Other materials available on a custom basis.

\*\* Plastic nuts only. See bronze nut section for information on our bronze nut products, page 33.

# Engineering Guidelines for Lead Screws

## Critical Speed Limits Chart for Lead Screws and Miniature Rolled Ball Screws

Every screw shaft has a rotational speed limit. That is the point at which the rotational speed sets up excessive vibration. This critical point is modified by the type of end bearing support used.

To use this chart, determine the required rpm and the maximum length between bearing supports. Next, select one of the four types of end support shown below. The critical speed limit can be found by locating the point at which rpm (horizontal lines) intersects with the unsupported screw length (vertical lines) as modified by the type of supports selected below. We recommend operating at no more than 80% of the critical speed limit to allow for misalignment and/or lack of screw straightness. If speed falls into dotted line, consult factory.

**Warning: Curves for the screw diameters shown are based on the smallest root (minor) diameter of the standard screws within the nominal size range and truncated at the maximum ball nut rotational speed. DO NOT EXCEED this rpm regardless of screw length.**

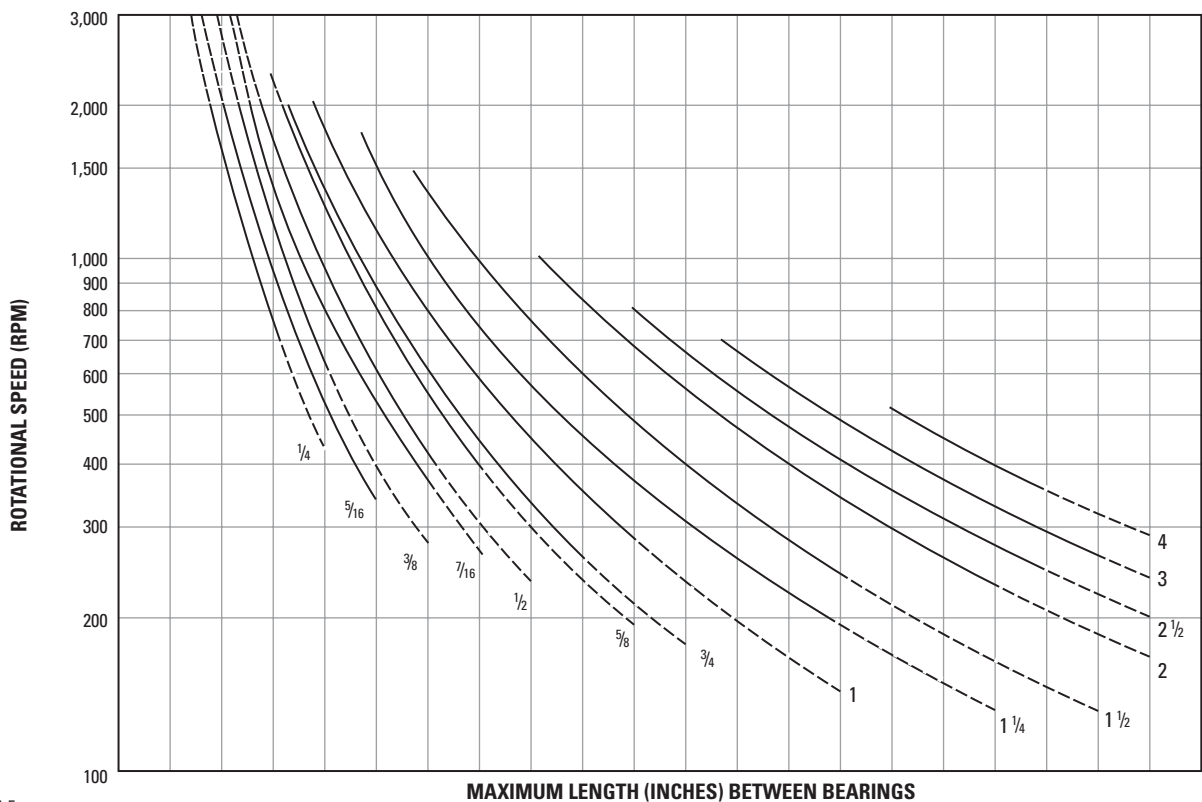

| Support Type           | Inches | MAXIMUM LENGTH (INCHES) BETWEEN BEARINGS |     |      |      |      |      |      |      |      |      |      |      |      |      |      |      |      |      |      |      |
|------------------------|--------|--|-----|------|------|------|------|------|------|------|------|------|------|------|------|------|------|------|------|------|------|
|                        |        | 6  | 12  | 18   | 24   | 30   | 36   | 42   | 48   | 54   | 60   | 66   | 72   | 78   | 84   | 90   | 96   | 102  | 108  | 120  | 126  |
| <b>A Fixed-Free</b>    | mm     | 152                                      | 304 | 457  | 609  | 762  | 914  | 1056 | 1219 | 1371 | 1524 | 1676 | 1828 | 1981 | 2133 | 2286 | 2438 | 2590 | 2743 | 3048 | 3200 |
| <b>B Simple-Simple</b> | mm     | 254                                      | 508 | 762  | 1016 | 1270 | 1524 | 1778 | 2032 | 2286 | 2540 | 2794 | 3048 | 3302 | 3556 | 3810 | 4064 | 4318 | 4572 | 4826 | 5080 |
| <b>C Fixed-Simple</b>  | mm     | 304                                      | 609 | 914  | 1219 | 1549 | 1854 | 2159 | 2463 | 2768 | 3073 | 3378 | 3683 | 4013 | 4318 | 4622 | 4927 | 5232 | 5537 | 5842 | 6146 |
| <b>D Fixed-Fixed</b>   | mm     | 381                                      | 762 | 1143 | 1524 | 1905 | 2286 | 2667 | 3022 | 3403 | 3784 | 4165 | 4546 | 4927 | 5308 | 5689 | 6070 | 6451 | 6832 | 7213 | 7569 |

# Engineering Guidelines for Lead Screws

## Column Loading Capacities Chart for Lead Screws and Miniature Rolled Ball Screws

Use the chart below to determine the Maximum Compression Load for Screw Shaft. Usually, screw operated in tension can handle loads up to the rated capacity of the nut, providing the screw length is within standard lengths. End supports have an effect on the load capacity of screws. The four standard variations are shown below with corresponding rating adjustments. Find the point of intersecting lines of load (horizontal) and length (vertical) to determine the minimum safe diameter of screw. If loads fall into dotted lines, consult factory.

**Warning: DO NOT EXCEED ball nut capacity. Curves for the screw diameters shown are based on the smallest root (minor) diameter of the standard screws within the nominal size range.**

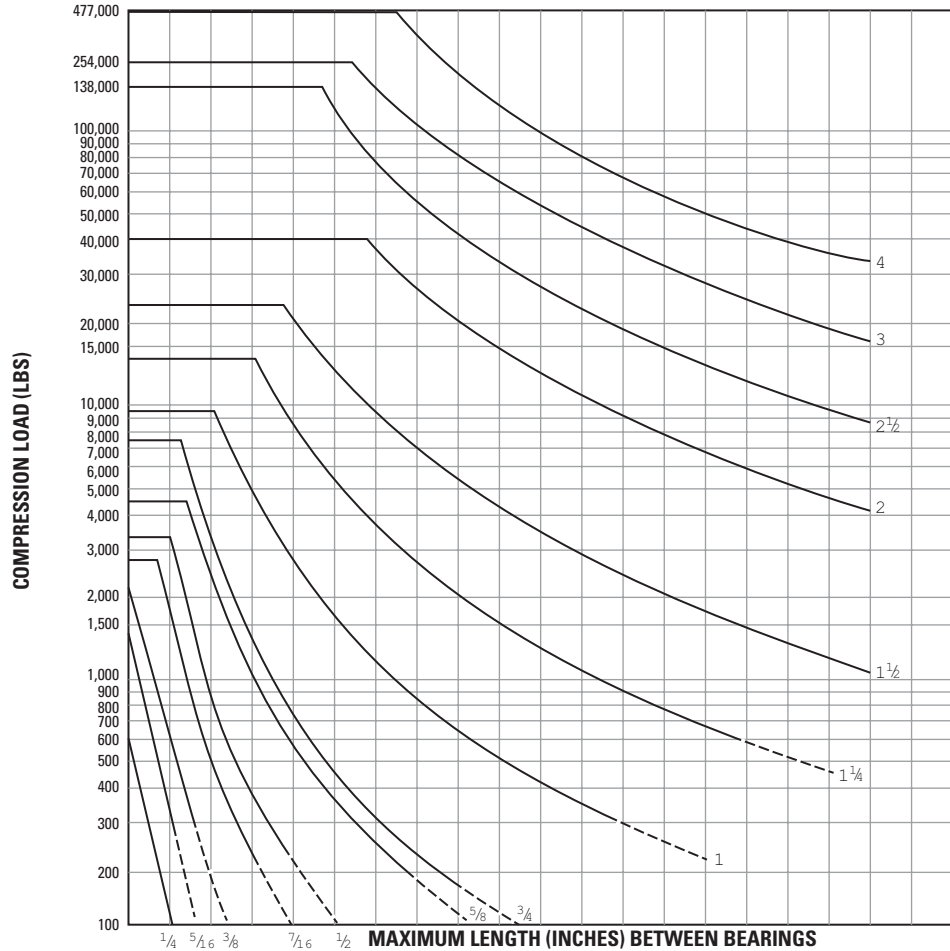

| Support Condition      | Inches | 5   | 10   | 15   | 20   | 25   | 30   | 35   | 40   | 45   | 50   | 55   | 60   | 65   | 70   | 75   | 80   | 85   | 90   | 95   |
|------------------------|--------|-----|------|------|------|------|------|------|------|------|------|------|------|------|------|------|------|------|------|------|
| <b>A Fixed-Free</b>    | mm     | 127 | 254  | 381  | 508  | 635  | 762  | 889  | 1016 | 1143 | 1270 | 1397 | 1524 | 1651 | 1778 | 1905 | 2032 | 2159 | 2286 | 2413 |
| <b>B Simple-Simple</b> | Inches | 10  | 20   | 30   | 40   | 50   | 60   | 70   | 80   | 90   | 100  | 110  | 120  | 130  | 140  | 150  | 160  | 170  | 180  | 190  |
|                        | mm     | 254 | 508  | 762  | 1016 | 1270 | 1524 | 1778 | 2032 | 2286 | 2540 | 2794 | 3048 | 3302 | 3556 | 3810 | 4064 | 4318 | 4572 | 4826 |
| <b>C Fixed-Simple</b>  | Inches | 14  | 28   | 42   | 57   | 71   | 85   | 99   | 113  | 127  | 141  | 156  | 170  | 184  | 198  | 212  | 226  | 240  | 255  | 270  |
|                        | mm     | 356 | 711  | 1067 | 1448 | 1803 | 2159 | 2515 | 2870 | 3226 | 3581 | 3962 | 4318 | 4674 | 5029 | 5385 | 5740 | 6096 | 6477 | 6858 |
| <b>D Fixed-Fixed</b>   | Inches | 20  | 40   | 60   | 80   | 100  | 120  | 140  | 160  | 180  | 200  | 220  | 240  | 260  | 280  | 300  | 320  | 340  | 360  | 380  |
|                        | mm     | 508 | 1016 | 1524 | 2032 | 2540 | 3048 | 3556 | 4064 | 4572 | 5080 | 5588 | 6096 | 6604 | 7112 | 7620 | 8128 | 8636 | 9144 | 9652 |

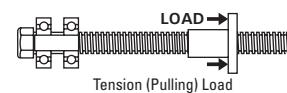
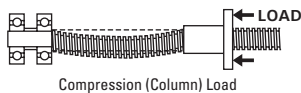



## Engineering Guidelines for Glide Screws

The Glide Screw™ is designed to actuate a moment load or a side load without additional linear guidance or support. Therefore, the screw deflection is the determinant feature and the following charts must be used when properly sizing a Glide Screw™ for an application.

### How the Glide Screw™ Works

The unique design of Glide Screw™ allows it to handle axial, radial and moment loads without additional guidance. The result is an efficient and space saving design that is quick and easy to install with reduced maintenance needs compared to traditional solutions.

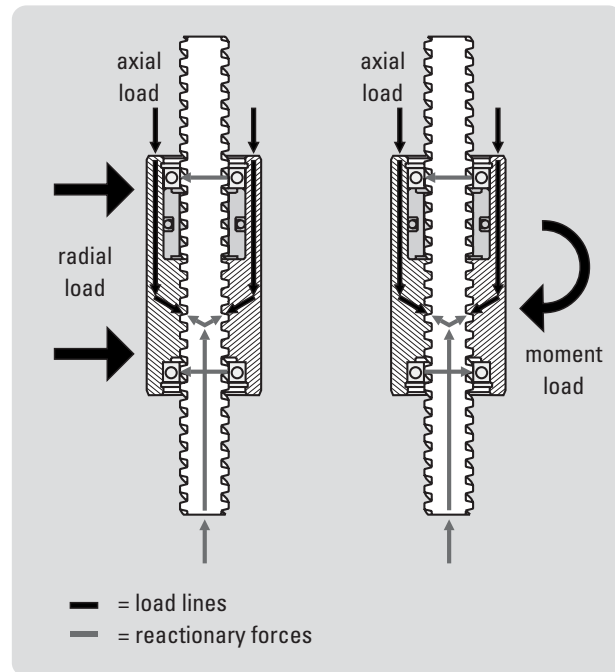

### End Support

Decide which type of end support you will use to enable accurate selection of diameter.

Fixed support – utilizes a support journal length at least  $1.5 \times$  the journal diameter – such as dual ball bearings.

Simple support – uses a single ball bearing, a plain bearing, or a bushing.

End support configurations shown at left:

1. Simple / simple
2. Fixed / simple
3. Fixed / fixed

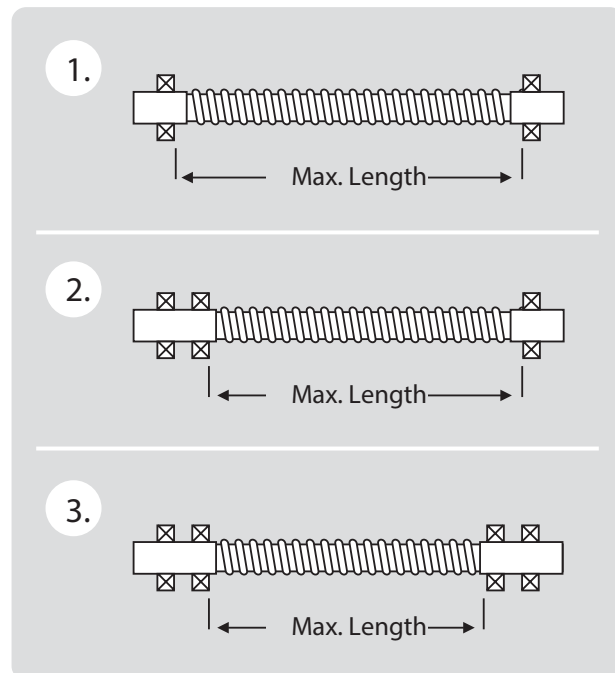

# Engineering Guidelines for Glide Screws

## Moment Load and Radial Load Charts

Determine your end support configuration and then use the following charts to properly size the nominal diameter of the Glide Screw™. Select a product diameter that lies above and / or to the right of the design moment or load. The lead of a Glide Screw™ is defined as the axial distance traveled for one revolution of the screw. Select the appropriate lead of your screw based on the desired speed and resolution of travel. Note that the Glide Screw™ is limited to 300 RPM.

### Inch Diameter Models

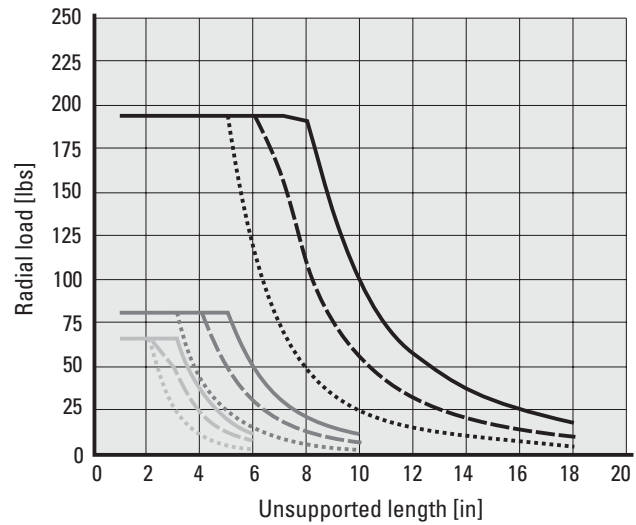
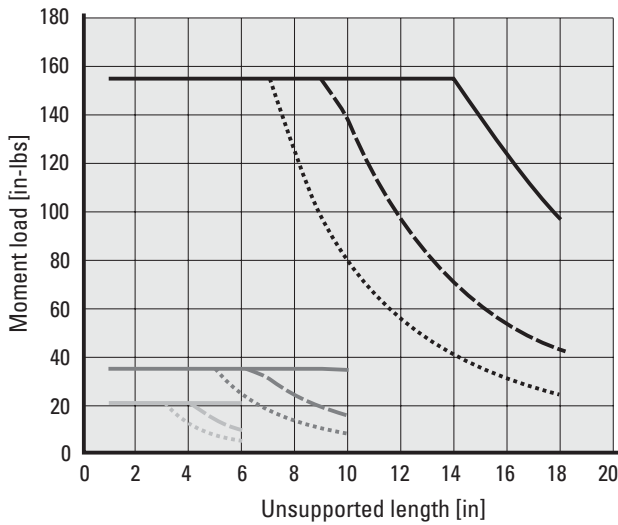

### Metric Diameter Models

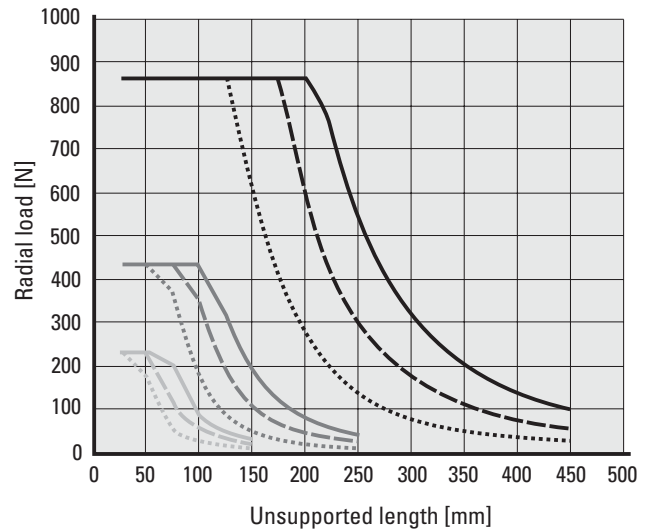
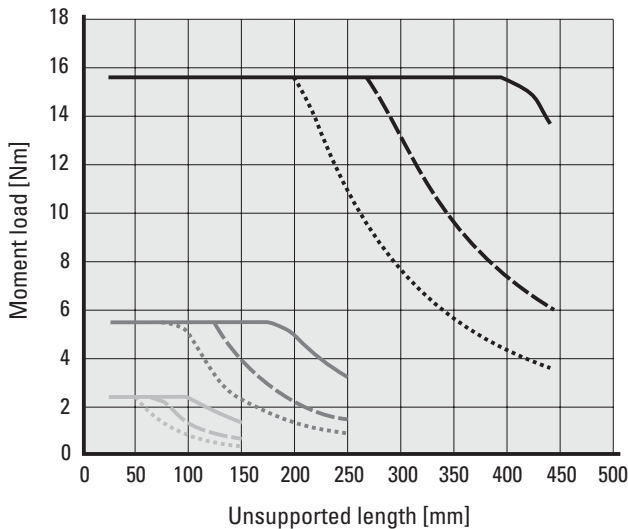

**Screw diameters**

- = 0.375 inch    ■ = 10 mm
- = 0.250 inch    ■ = 6 mm
- = 0.188 inch    ■ = 4 mm

**End support type**

- = fixed in both ends
- - - = simple in one end and fixed in other
- ..... = simple in both ends

**Conversion factors**

- 1.0 in-lb = 0.113 Nm
- 1.0 lb = 4.448 N

## Engineering Guidelines for Glide Screws

### Recommended end machining

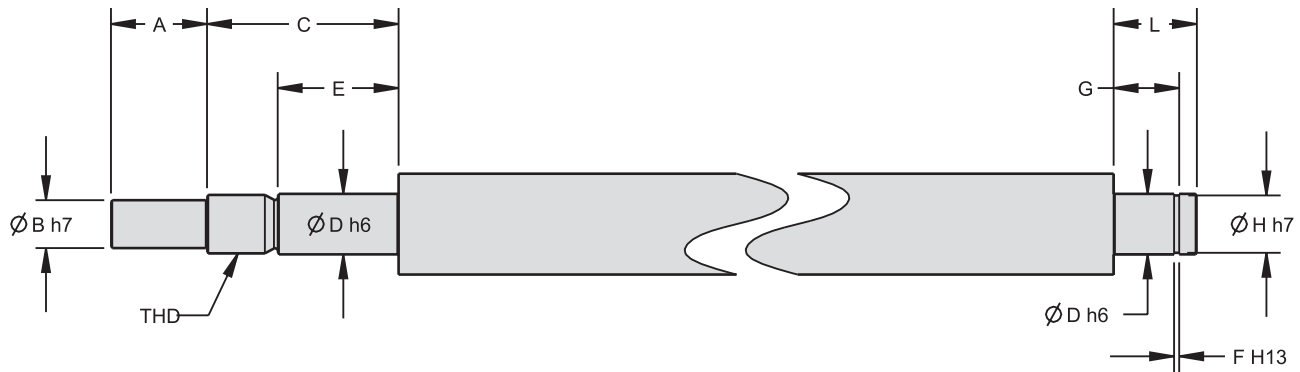

### End support type

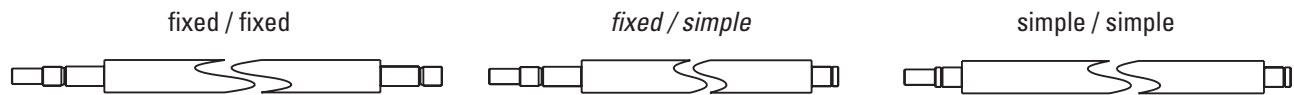

### Inch Series End Machining Dimensions

| Screw Diam. [in] | Screw Lead [in] | Screw Part No. | Root Diameter [in] | Recommended Bearing |         |        |                   | Dimensions [in] |       |       |       |       |       |       |       |       |         |
|------------------|-----------------|----------------|--------------------|---------------------|---------|--------|-------------------|-----------------|-------|-------|-------|-------|-------|-------|-------|-------|---------|
|                  |                 |                |                    | OD [mm]             | ID [mm] | W [mm] | Bearing Trade No. | A               | B     | C     | D     | E     | F     | G     | H     | L     | THD     |
| 0.188            | 0.050           | GS18x0050      | 0.12               | 7                   | 2.5     | 2.5    | 692X              | 0.197           | 0.098 | N/A   | 0.098 | N/A   | 0.022 | 0.120 | 0.075 | 0.157 | N/A     |
|                  | 0.125           | GS18x0125      | 0.13               |                     |         |        |                   |                 |       |       |       |       |       |       |       |       |         |
| 0.250            | 0.050           | GS25x0050      | 0.19               | 13                  | 4       | 5      | 624               | 0.295           | 0.118 | 0.610 | 0.157 | 0.374 | 0.020 | 0.217 | 0.150 | 0.256 | M4x0.5  |
|                  | 0.500           | GS25x0500      | 0.16               |                     |         |        |                   |                 |       |       |       |       |       |       |       |       |         |
| 0.375            | 0.063           | GS37x0063      | 0.30               | 19                  | 6       | 6      | 626               | 0.394           | 0.197 | 0.728 | 0.236 | 0.453 | 0.030 | 0.266 | 0.220 | 0.315 | M6x0.75 |
|                  | 0.500           | GS37x0500      | 0.27               |                     |         |        |                   |                 |       |       |       |       |       |       |       |       |         |
|                  | 1.000           | GS37x1000      | 0.24               |                     |         |        |                   |                 |       |       |       |       |       |       |       |       |         |

### Metric Series End Machining Dimensions

| Screw Diam. [mm] | Screw Lead [mm] | Screw Part No. | Root Diameter [mm] | Recommended Bearing |         |        |                   | Dimensions [mm] |      |       |      |       |      |      |      |      |         |
|------------------|-----------------|----------------|--------------------|---------------------|---------|--------|-------------------|-----------------|------|-------|------|-------|------|------|------|------|---------|
|                  |                 |                |                    | OD [mm]             | ID [mm] | W [mm] | Bearing Trade No. | A               | B    | C     | D    | E     | F    | G    | H    | L    | THD     |
| 4                | 1               | GS4x1M         | 2.8                | 7                   | 2.5     | 2.5    | 692X              | 5.00            | 2.50 | N/A   | 2.50 | N/A   | 0.55 | 3.05 | 1.90 | 4.00 | N/A     |
|                  | 4               | GS4x4M         | 2.8                |                     |         |        |                   |                 |      |       |      |       |      |      |      |      |         |
|                  | 8               | GS4x8M         | 2.8                |                     |         |        |                   |                 |      |       |      |       |      |      |      |      |         |
| 6                | 1               | GS6x1M         | 4.6                | 13                  | 4       | 5      | 624               | 7.50            | 3.00 | 15.50 | 4.00 | 9.50  | 0.51 | 5.51 | 3.81 | 6.50 | M4x0.5  |
|                  | 6               | GS6x6M         | 4.4                |                     |         |        |                   |                 |      |       |      |       |      |      |      |      |         |
|                  | 12              | GS6x12M        | 4.4                |                     |         |        |                   |                 |      |       |      |       |      |      |      |      |         |
| 10               | 2               | GS10x2M        | 7.3                | 13                  | 6       | 6      | 626               | 10.00           | 5.00 | 18.50 | 6.00 | 11.50 | 0.76 | 6.76 | 5.59 | 8.00 | M6x0.75 |
|                  | 6               | GS10x6M        | 8.4                |                     |         |        |                   |                 |      |       |      |       |      |      |      |      |         |
|                  | 12              | GS10x12M       | 8.4                |                     |         |        |                   |                 |      |       |      |       |      |      |      |      |         |

# Engineering Guidelines for Glide Screws

## Basic Installation Guidelines

The success of the Glide Screw™ in an application is primarily dependent on the end support configuration. Since the Glide Screw™ is a combination of a lead screw and linear bearing, the ability to handle non-axial loads while maintaining positional accuracy is the key to a successful installation. The load capacity curves are based on screw deflection and not the lead nut capacity. Therefore, stiffness of the assembly determines load capacity.

### Installation Step-by-Step

#### 1. Select end support configuration

A fixed bearing support should be selected when possible. A simple support is typically a single radial bearing that is allowed to float axially to compensate for misalignments. Typical methods of attaching end supports is either base mounting or flange mounting.

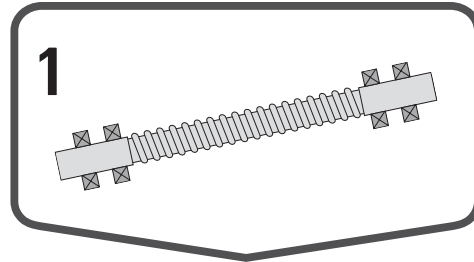

#### 2. Select motor and drive configuration

Select a motor and your means for coupling the screw to the motor. Typically this is done by a belt, gearing or an in-line coupler. It is also possible to directly integrate a Glide Screw™ with a stepper motor, which can reduce complexity and save space.

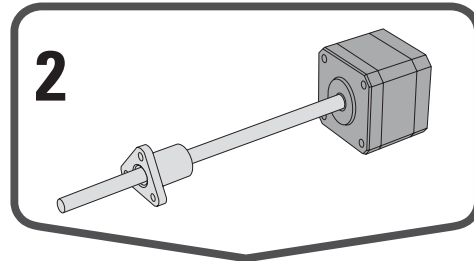

#### 3. Select nut mounting interface

The standard configurations for the glide nut are flanged nuts and cylindrical nuts but are by no means the only solutions. Custom configurations, custom mounting and design assistance are available from Thomson.

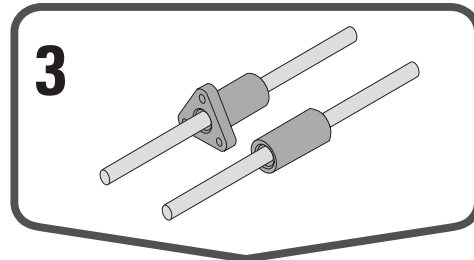

#### 4. Determine anti-rotation method

The Glide Screw™ requires an external anti-rotation feature on the nut housing to function correctly. Two examples of acceptable methods are the finger / slot solution or the bushing / linear shaft solution.

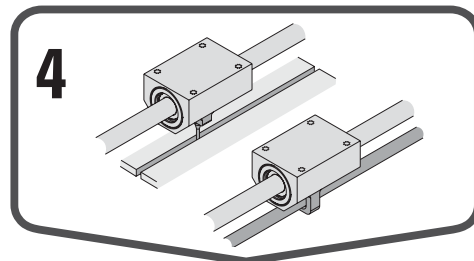

#### 5. Mount the assembly into the application

The actual mounting of the Glide Screw™ is easy once all of the peripherals have been determined and designed. Just bolt the assembly in place and fire up the system. No critical alignment procedures are necessary as the drive system and linear guidance are already in perfect alignment.

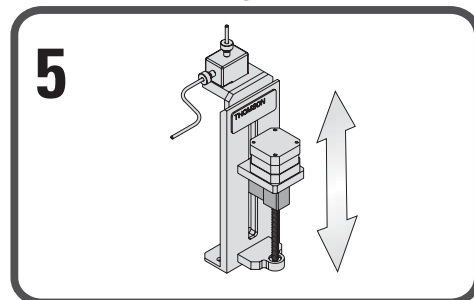

## Ball Screws — Inch Series Engineering



Need a quote or have a question about an application? Contact us in North America at:

Phone: 540-633-3549

Fax: 540-639-4162

Email: [thomson@thomsonlinear.com](mailto:thomson@thomsonlinear.com)

## Engineering Guidelines for Inch Series Ball Screws

### Selecting a Ball Screw Assembly for Your Application — Inch Series

A ball screw assembly is a mechanical device for translating rotational motion to linear motion. As well as being able to apply or withstand high thrust loads, they can do so with minimum internal friction. They are made to close tolerances and are therefore suitable for use in situations in which high precision is necessary. The selection of the correct ball screw assembly for a specific application is an iterative process to determine the smallest envelope and most cost-effective solution. Below is a list of the most common (but not complete) design considerations used to select a ball screw assembly.

- Compression or Tension Load
- Linear Velocity
- Positional Accuracy and Repeatability
- Required Life Expectancy
- Mounting Configuration
- Dimensional Constraints
- Input Power Requirements
- Environmental Condition

At a minimum, the design load, linear velocity, and positional accuracy should be the known inputs and are used to calculate the diameter, lead, and load capacity of the ball screw assembly. Individual ball screw components are then selected based on life, dimensional constraints, mounting configuration, and environmental conditions.

The following procedure will take you through the most common application-based selection of a ball screw assembly. As no two applications are the same, so the determination process is never the same.

1. Determine the required positional accuracy and repeatability that your application requires (page 194). Backlash is the linear independent motion between the ball screw and the ball nut and can be controlled by preloading the ball nut (page 195). The manufacturing process, rolled screws versus ground screws, dictates the accuracy (page 195).
2. Determine how you plan to mount the ball screw assembly into your machine (see page 197). The configuration of the end supports and the travel distance (Max L) will dictate the load and speed limitations of the ball screw.
3. A ball nut in tension can handle loads up to the rated capacity of the nut. For a ball nut in compression, calculate the Permissible Compression Loading (page 193) or use the Compression Loading Chart (page 201) to select a ball screw diameter that meets or exceeds your design load.
4. Calculate the lead of the ball screw that will produce the speed requirement (page 202).
5. The ball nut life can then be calculated using the Dynamic Load Rating ( $C_{am}$ ) provided in the catalog detail pages or use the Life Expectancy Charts (pages 199 or 200).
6. Every ball screw has a rotation speed limit, which is the point of excessive vibration/harmonics in the screw. The critical speed is dependent on the end support configuration. Calculate the Critical Screw Speed of the chosen ball screw (page 193) or use the Acceptable Speed Chart (page 198) to determine the critical speed.
7. If the load, life and speed calculations confirm that the selected ball screw assembly meets or exceeds the design requirements, then proceed to the next step. If not... Larger diameter screws will increase the load capacity and increase the speed rating. Smaller lead screws will decrease the linear speed (assuming constant input motor speed), increase the motor speed (assuming constant linear speed), and decrease the input torque required. Higher lead screws will increase the linear speed (assuming constant input motor speed), decrease the input motor speed (assuming constant linear speed), and increase the input torque required. Repeat steps 3 thru 5 until the correct solution is obtained.
8. Determine how the ball nut will interface into your application. A ball nut flange is the typical method of attaching the ball nut to the load. Threaded ball nuts and cylindrical ball nuts are alternative ways to provide the interface.
9. Additional design considerations and features are also available. Preloaded ball nuts are available to eliminate system backlash and increase stiffness. Wiper kits to protect the assembly from contaminants and to contain lubrication are standard on some units and optional on most others. Bearing supports and end machining are also available as options for most ball screws.
10. The final considerations are system mounting and lubrication. The ball nut should be loaded axially only as any radial loading significantly reduces the performance of the assembly (page 196). The assembly should also be properly aligned with the drive system, bearing supports, and load to achieve optimal performance and life (page 196). The ball screw assembly should never be run without proper lubrication. Many lubricants are available depending on the application and environment (page 196).

Note: Application and customer service support is available to assist in the selection of your ball screw assembly. Please contact your local Thomson representative or the customer support center (1-540-633-3549 — TCS) for any additional assistance.

## Engineering Guidelines for Inch Series Ball Screws

### Ball Screw Assembly Selection Example:

Inputs:

Load: 30,000 lb. Compression Maximum  
10,000 lb. dynamic

Linear Speed: 200 in./min.

Input Speed: 400 rpm

Travel: 85 in.

Life:  $2 \times 10^6$  inches

#### 1. Accuracy (pages 194 and 195)

No Preload and Standard Rolled ( $\pm 0.004$  in./12 in.)

#### 2. End Supports (page 197)

Fixed/Supported

#### 3. Determine Screw Diameter

From Chart (page 201):  $\varnothing 2.000$  in.

From Equation (page 193):  $30,000 / .8 = \frac{2.0 \times 1.405 \times 10^7 \times d_r^4}{(85)^2}$

therefore,  $d_r = 1.762$  in.

#### 4. Determine Lead (page 192)

Lead =  $\frac{200 \text{ in./min.}}{400 \text{ rpm}}$  therefore, Lead = .500 in.

#### 5. Determine Life

From Catalog (page 83): Dynamic Load = 21,306 lbs.

From Equation (page 192): Life (inches) =  $\left[ \frac{21,306}{10,000} \right]^3 \times 10^6$

therefore, Life =  $9.7 \times 10^6$  inches

Verified via Chart (page 199)

#### 6. Determine Critical Speed

From Catalog (page 86): Screw Root Diameter is 1.85 in.

From Equation (page 193):  $.8 \times 1.47 \times 4.76 \times 10^6 \times \frac{d_r}{l^2}$

therefore, Speed = 1,433 rpm

Verified via Chart (page 198)

#### 7. Design Verification

OK per load, speed and life.

#### 8. Load Interface

Flanged connection preferred.

#### 9. Additional Requirements

- Wipers required
- Bearing Supports required
- End Machining needed
- Right Hand Thread
- Carbon Steel

#### 10. Mounting and Lubrication

System will require motor interface and linear rails for alignment.  
TriGel 450R

Product Selection (page 81):

Ball Nut: P/N 7833235

Ball Screw: P/N 7820600

Wiper Kit: P/N 5702659 (included)

Flange: P/N 5707574

# Engineering Guidelines for Inch Series Ball Screws

## Design Formulas

These formulas allow you to calculate a number of important factors which govern the application of Thomson ball screws.

### 1. Ball Screw Life (L)

The ball screw assembly's useful life will vary according to load and speed. Life is typically rated at 90% confidence, L10 (which represents time at which 90% of assemblies still perform).

Functional life should be determined by approximating equivalent rotational speed and loading force over typical performance cycles.

#### Simple rotational speed profile

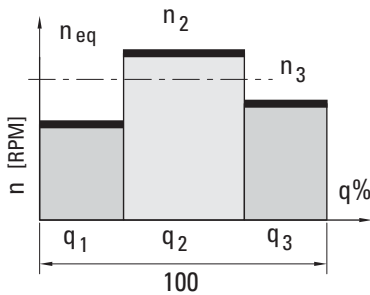

$$n_{eq} [\text{min}^{-1}] = \sum_{i=1}^n n_i \times \frac{q_i}{100}$$

#### Simple loading profile (1)

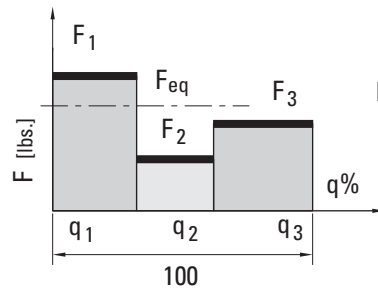

$$F_{eq} [\text{lbs.}] = \left( \sum_{i=1}^n F_i^3 \times \frac{n_i}{n_{eq}} \times \frac{q_i}{100} \right)^{1/3}$$

#### Simple loading profile (2)

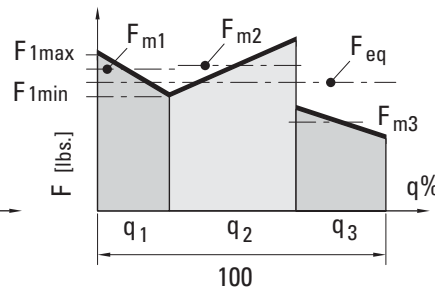

$$F_{eq} [\text{lbs.}] = \left( \sum_{i=1}^n F_{mi}^3 \times \frac{n_i}{n_{eq}} \times \frac{q_i}{100} \right)^{1/3}$$

#### Modified Life

$$L_{10} [\text{inches}] = \left[ \frac{C_{am}}{F_{eq}} \right]^3 \times 10^6$$

$$L_{h10} [\text{hours}] = \frac{L_{10}}{n_{eq} \times 60}$$

#### Parameters:

- $n_{eq}$  = Travel Rate (inches/min)
- $F_{eq}$  = equivalent operating load [lbs.]
- $C_{am}$  = dynamic load rating [lbs.]  
(see product detail pages)  
(Based on 1.0 million inches)

### 2. Rotational Speed Required for a Specific Linear Velocity

$$n = \frac{\text{Travel Rate (in.} \times \text{min.}^{-1})}{\text{Lead (in.)}} \quad n = \text{rpm}$$

### 3. Machine Service Life

After ball screw life (L) is calculated, apply it to the following formula to determine machine service life.

$$\text{Machine Service Life (in years)} = \frac{L_{h10} [\text{hours}]}{(\text{machine operating hours}) \cdot (\text{days/year}) \cdot \left( \frac{\text{ball screw operating hours}}{\text{machine operating hours}} \right)}$$



## Engineering Guidelines for Inch Series Ball Screws

### 4. Torque

a. Driving torque:  $T_d \text{ (lb}_f\text{-in.)} = \frac{F_{eq} \times P}{2\pi e} = 0.177 \times F_{eq} \times P$

b. Backdrive torque:  $T_b \text{ (lb}_f\text{-in.)} = \frac{F_{eq} \times P \times e}{2\pi} = 0.143 \times F_{eq} \times P$

(conversion of linear to rotational motion)

$F_{eq}$  = Equivalent Operating Load (lb<sub>f</sub>)  
 $P$  = Lead (in.)  
 $e$  = Efficiency = 0.90  
 $T_d$  = Driving Torque (lb<sub>f</sub>-in.)  
 $T_b$  = Backdrive Torque (lb<sub>f</sub>-in.)  
 1 lb<sub>f</sub>-in. = 0.113 (N•m)

### 5. Power

$P_d \text{ (hp)} = \frac{F_{eq} \times P}{(2\pi) e} \times \frac{n}{6.3021 \times 10^4} = \frac{F_{eq} \times P \times n}{3.564 \times 10^5}$

$P_d$  = Power (hp)  
 $n$  = rpm  
 1 hp = 746 W



### 6. Permissible Rotational Speed

The permissible rotational speed depends on two factors: critical screw speed and critical nut speed.

#### 6a. Critical Screw Speed

The critical screw speed is related to the natural frequency of the screw shaft. Exceeding this value may result in excessive vibration. The critical screw speed may be found using the following equations or the chart on page 198.

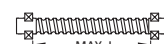
$n_c = C_s \times 4.76 \times 10^5 \times \frac{d_r}{l^2}$   $n_c$  = Critical Speed (rpm)  
 $n_s = n_c \times S$   $n_s$  = Safe Drive Speed  
 $d_r$  = Root Diameter (in.)  
 $l$  = Length between Bearing Supports (in.)  
 $S$  = Safety Factor (0.8 maximum)  
 $C_s$  = End Fixity Factor

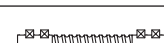
| End Fixity Factor - Critical Screw Speed |   |       |
|--|---|-------|
| End Supports                             |   | $C_s$ |
| A  |  One end fixed, one end free       | 0.36  |
| B  |  Both ends supported              | 1.00  |
| C  |  One end fixed, one end supported | 1.47  |
| D  |  Both ends fixed                  | 2.23  |

#### 6b. Critical Nut Speed

The critical nut speed is related to the velocity of the ball bearings rotating around the screw shaft. Exceeding this value may result in permanent damage to the ball recirculation components. Thomson recommends a maximum DN value of 3000 for standard tube transfer designs with a lead to diameter ratio less than 2/3. Thomson recommends a maximum DN value of 5250 for high speed nuts equipped with deflectors.

$DN = d_0 n$



where

$d_0$  = nominal shaft diameter (in)  
 $n$  = rotational speed of shaft (rpm)

### 7. Permissible Compression Loading

Exceeding the recommended maximum compression force may result in buckling of the screw shaft.

$F_c = \frac{C_s \times 1.405 \times 10^7 \times d_r^4}{l^2}$   $F_c$  = Critical Buckling Force (lbs.)  
 $F_s = F_c \times S$   $F_s$  = Safe Compression Force (lbs.)  
 $d_r$  = Root Diameter (in.)  
 $l$  = Max Unsupported Length (in.)  
 $S$  = Safety Factor (0.8 maximum)  
 $C_s$  = End Fixity Factor

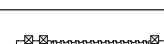
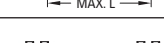
| End Fixity Factor - Permissible Compression Loading |   |       |
|---|---|-------|
| End Supports  |   | $C_s$ |
| A   |  One end fixed, one end free      | 0.25  |
| B   |  Both ends supported              | 1.00  |
| C   |  One end fixed, one end supported | 2.00  |
| D   |  Both ends fixed                  | 4.00  |

# Engineering Guidelines for Inch Series Ball Screws

## Accuracy Classes

Accuracy is a measure of how closely a motion system will approach a command position. Perfect accuracy, for example, means that advancing a ball nut a precise amount from a given point on the screw always requires exactly the theoretically predicted number of revolutions.

Inch ball screws are produced in two main tolerance classes: Precision and Precision Plus. Precision grade ball screws are used in applications requiring only coarse movement or those utilizing linear feedback for position location. As such, most Precision grade screws are provided with nuts having backlash. Precision Plus grade ball screws are used where repeatable positioning within microns is critical, without the use of a linear feedback device.

Differences between Precision and Precision Plus grades are highlighted in the graph. Precision grade screws allow greater cumulative variation over the useful length of the screw. Precision Plus grade screws contain accumulation of lead error to provide precise positioning over the screw's entire useful length.

### Precision Plus Ball Screws

$$\text{Maximum error over useful length} = e_p + 1/2V_{up} + C$$

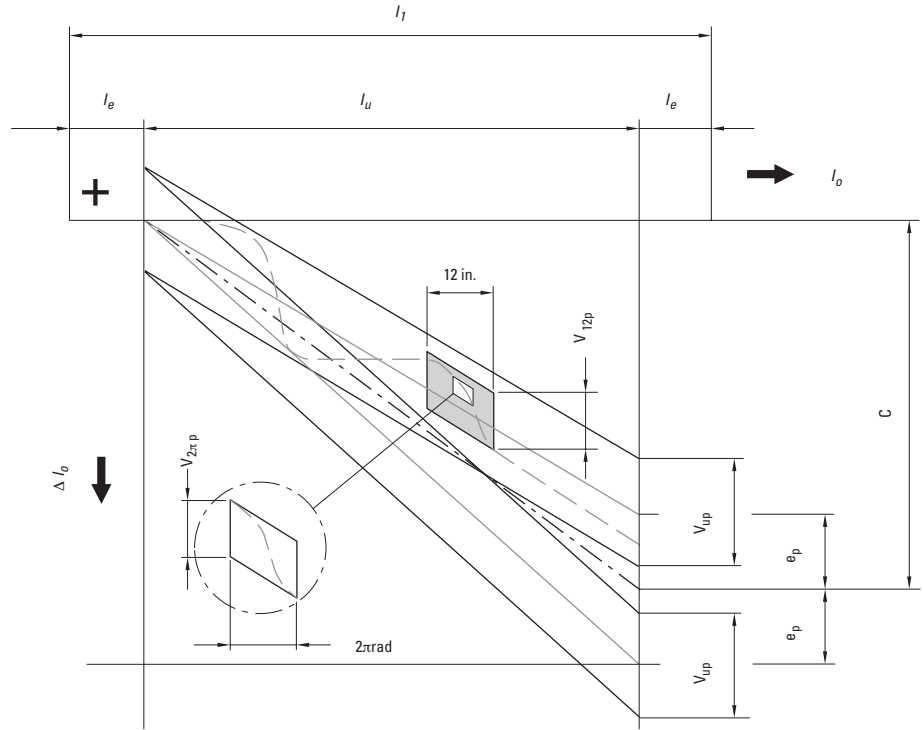

### Precision Ball Screws

$$\text{Maximum error over useful length} = e_p$$

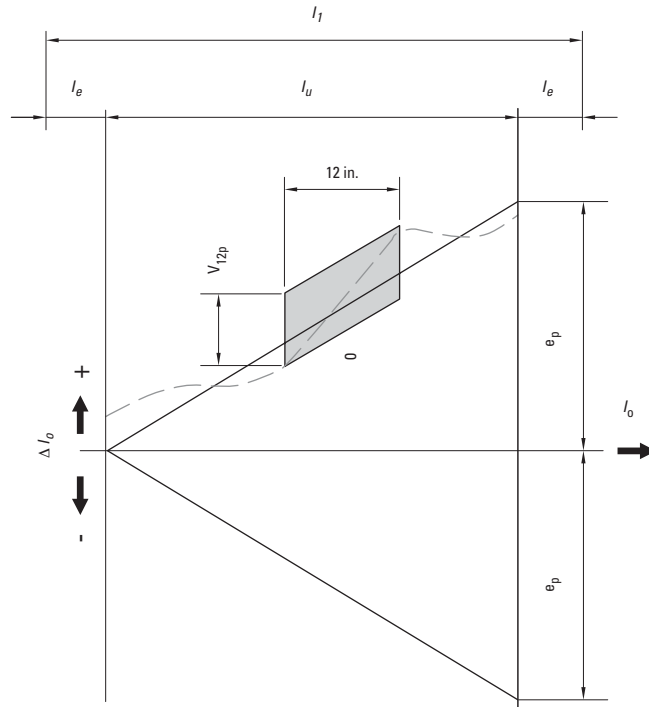

- $l_o$  = nominal travel
- $l_1$  = thread length
- $l_o$  = travel deviation
- $l_u$  = useful travel
- $l_e$  = excess travel
- $C$  = travel compensation for useful travel (std. = 0)
- $e_p$  = tolerance for actual mean travel deviation (the difference between the maximum and minimum values of the permissible actual mean travel)
- $V_{up}$  = permissible travel variation within useful travel,  $l_u$
- $V_{12p}$  = permissible travel deviation within 12 inch travel
- $V_{2\pi p}$  = permissible travel deviation within 1 revolution

# Engineering Guidelines for Inch Series Ball Screws

## Permissible Travel Variation Over Usable Length

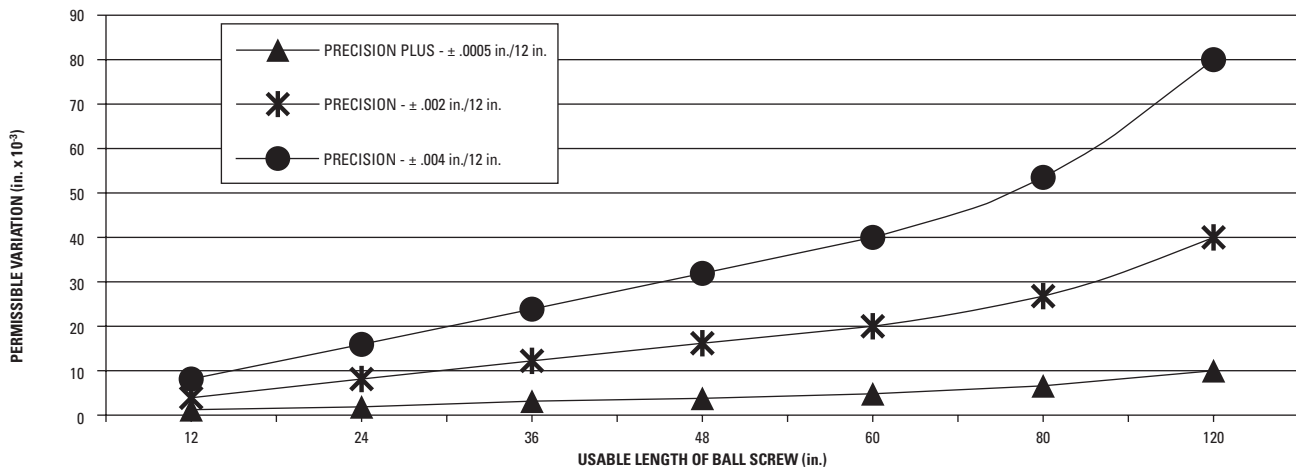

| Tolerance Class | Lead Accuracy $V_{300p}$ | Permissible Travel Deviation $V_{up}$ (in. x $10^{-3}$ ) Over Screw Length $l_u$ (in.) |    |    |    |    |    |      |     |
|-----------------|--------------------------|--|----|----|----|----|----|------|-----|
|                 |                          | $l_u =$  | 12 | 24 | 36 | 48 | 60 | 80   | 120 |
| Precision Plus* | ±.0005 in./12 in.        | $V_{up}$ (in.)   | 1  | 2  | 3  | 4  | 5  | 6.67 | 10  |
| Precision       | ±.002 in./12 in.         | $V_{up}$ (in.)   | 4  | 8  | 12 | 16 | 20 | 26.7 | 40  |
| Precision*      | ±.004 in./12 in.         | $V_{up}$ (in.)   | 8  | 16 | 24 | 32 | 40 | 53.3 | 80  |

\* Standard product tolerances

## Preload Types

### Skip-Lead Preload

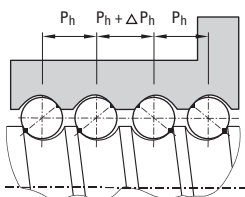

- The lead is offset within the ball nut to provide a precise preload.
- Typically used where both repeatability and high stiffness are required.

### Double-Nut Adjustable Preload

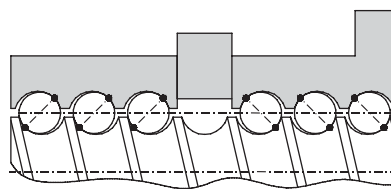

- A compression spring is used to axially load two ball nuts against each other.
- Typically used for positioning applications where repeatability is critical.

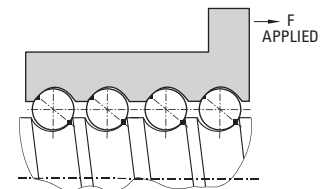

- Axial play is present between screw and nut (typically .002"-.008" depending on size).
- Typically used for transport or vertical applications.

### No Preload

## Engineering Guidelines for Inch Series Ball Screws

### Lubrication Guidelines

Ball screws must be lubricated to operate properly and achieve the rated life. We recommend using TriGEL-450R or TriGEL-1800RC for lubricating ball screws. Other oils and greases may be applicable but have not been evaluated.

The TriGEL grease can be applied directly to the screw threads near the root of the ball track. Some ball nut sizes are available with threaded lube holes for mounting lubrication fittings. For these ball nuts, the TriGEL grease can be pumped directly into the nut. Please refer to the catalog detail views to verify which ball nuts have the threaded lube holes. It is recommended to use these nuts in conjunction with a wiper kit to contain the lubricant in the body of the nut.

Ball screws may require lubrication frequently depending on both environmental and operating conditions. If the lubricant appears to be dispersed before this point or has become dry or crusted, the maintenance



interval should be reduced. Before adding additional grease, wipe the screw clean, removing the old grease and any particulate

contamination seen on the screw. If oil is being used, the best results may be obtained by utilizing a continuous-drip type applicator.

### Nut Loading

Axial loading (on nut or screw) is optimal for performance and life. For applications requiring radial loads, please contact us.

Axial Loading: optimal

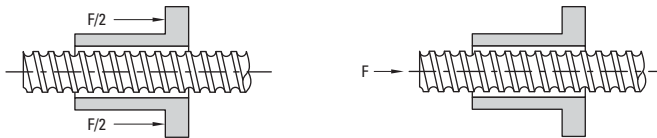

Radial Loading: detrimental\*

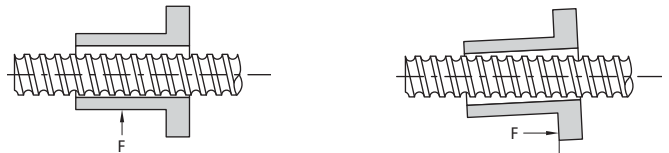

\* Minimize radial loading to less than 5% of the axial load.

### Nut Mounting

Use the following guidelines to achieve optimal performance

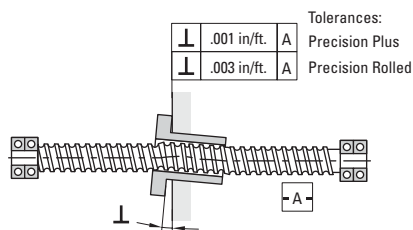
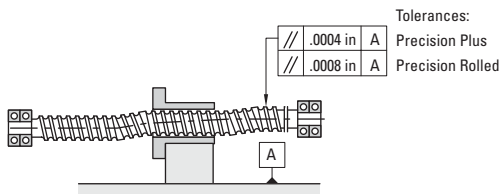

## Engineering Guidelines for Inch Series Ball Screws

### Bearing Support Reference Drawings (End Fixity)

**Critical Speed** — That condition where the rotary speed of the assembly sets up harmonic vibrations. (Refer to Figure 1.) These vibrations are the result of shaft diameter, unsupported length, type of bearing support, position of the ball nut in the stroke, how the ball nut is mounted, the shaft or ball nut rpm, etc. (Note: Shaft vibrations may also be caused by a bent screw or faulty installation alignment.) The four end fixity drawings (A, B, C, and D) show the bearing configurations for supporting a rotating shaft. The selection chart for Travel Rate vs. Length on page 198, shows these same configurations at the bottom of the chart and factors in their effect on critical shaft speed for the unsupported screw length.

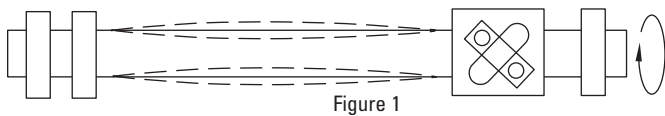
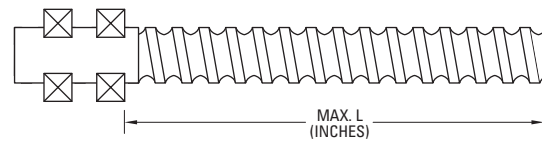

Figure 1

### Bearing Support vs. Speed (travel rate or rpm)

A – One end fixed, other end free



B – Both ends supported

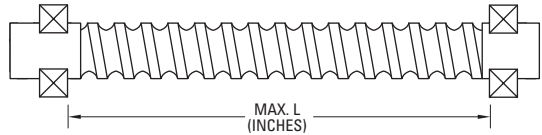

C – One end fixed, other end supported

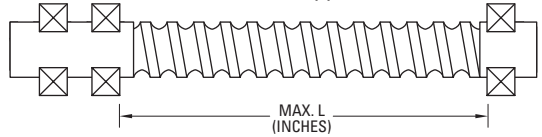

D – Both ends fixed

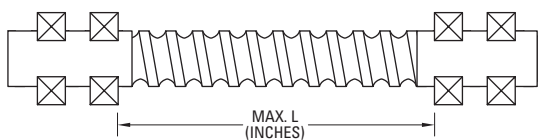

**Tension Loads** — Those loads where the force pulls on the bearing and its support. (Refer to Figure 2.) Where practical, applications should be designed to function with the load in tension to achieve the widest possible selection of screw sizes. Ball screws operating in both tension and compression may be preloaded between the support bearings or mounted per the guidelines under Compression Loads.

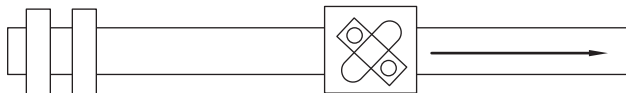

Figure 2

**Compression Loads** — Those loads where the force pushes on the bearing and its support. (Refer to Figure 3.) Compression loads tend to cause the screw shaft to bend. This normally requires a ball screw with a larger diameter than one for tension loading only. The four end fixity drawings (A, B, C and D) show the bearing configurations for supporting a shaft subject to compression loads. The selection chart for Compression Load vs. Length, on page 201, shows these same configurations at the bottom of the chart and factors in their effect on the unsupported length of the screw for compression loads.

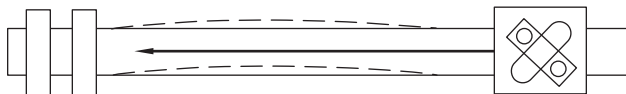
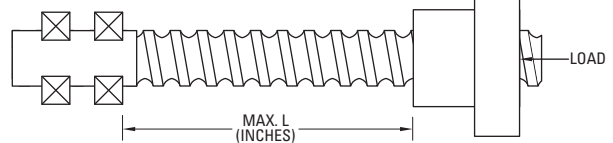

Figure 3

### Bearing Support vs. Compression Load on Screws

A – One end fixed, other end free



B – Both ends supported

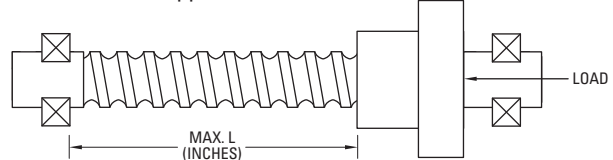

C – One end fixed, other end supported

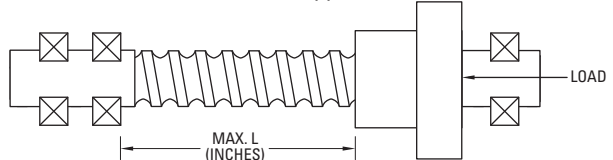

D – Both ends fixed

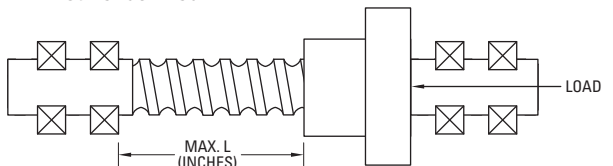

# Engineering Guidelines for Inch Series Ball Screws

## Acceptable Speed† vs. Length for Screws

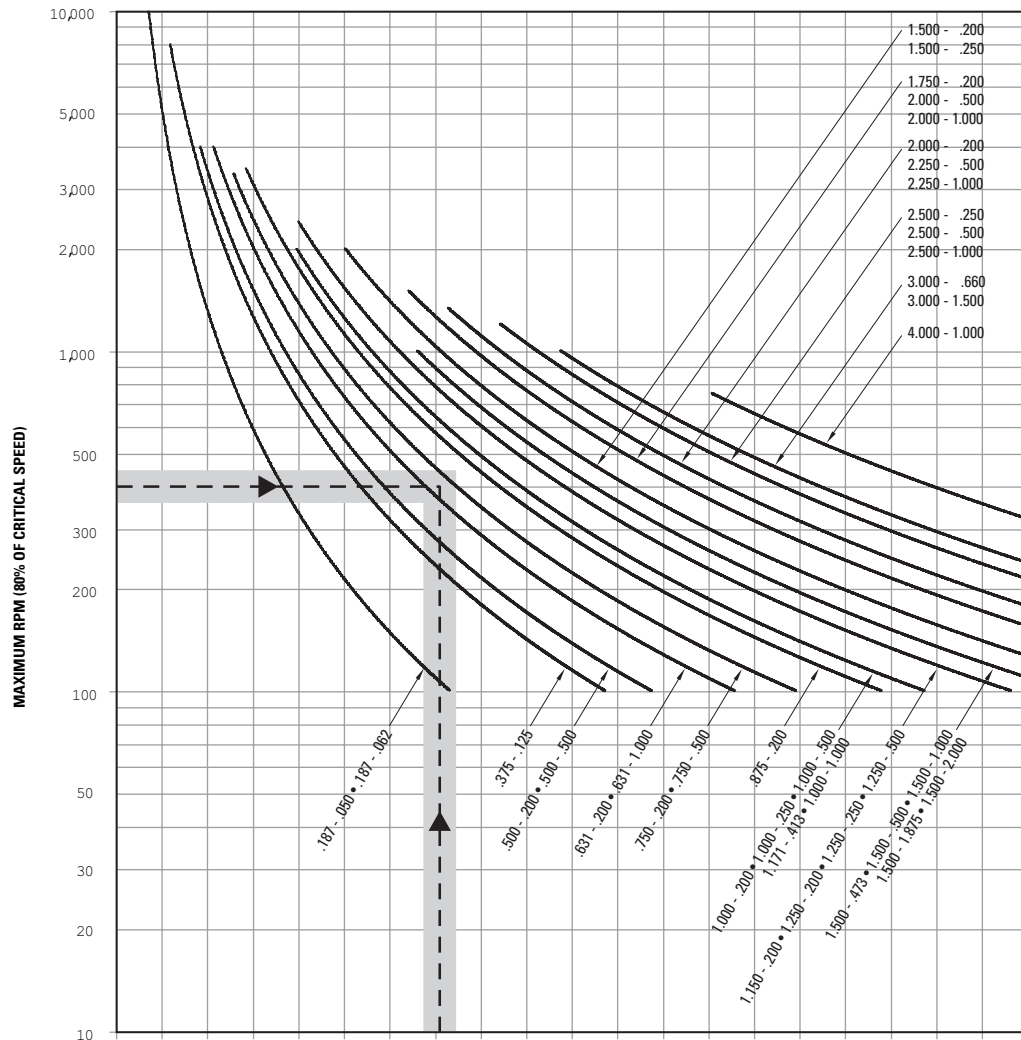

**END SUPPORT TYPE**

One end fixed, other end free



|        |     |     |     |     |     |     |      |      |      |      |      |      |      |      |      |      |      |      |      |      |
|--------|-----|-----|-----|-----|-----|-----|------|------|------|------|------|------|------|------|------|------|------|------|------|------|
| Inches | 6   | 12  | 18  | 24  | 30  | 36  | 42   | 48   | 54   | 60   | 66   | 72   | 78   | 84   | 90   | 96   | 102  | 108  | 114  | 120  |
| mm     | 152 | 304 | 457 | 609 | 762 | 914 | 1066 | 1219 | 1371 | 1524 | 1676 | 1828 | 1981 | 2133 | 2286 | 2438 | 2590 | 2743 | 2895 | 3048 |

Both ends supported

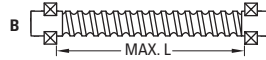

|        |     |     |     |      |      |      |      |      |      |      |      |      |      |      |      |      |      |      |      |      |
|--------|-----|-----|-----|------|------|------|------|------|------|------|------|------|------|------|------|------|------|------|------|------|
| Inches | 10  | 20  | 30  | 40   | 50   | 60   | 70   | 80   | 90   | 100  | 110  | 120  | 130  | 140  | 150  | 160  | 170  | 180  | 190  | 200  |
| mm     | 254 | 508 | 762 | 1016 | 1270 | 1524 | 1778 | 2032 | 2286 | 2540 | 2794 | 3048 | 3302 | 3556 | 3810 | 4064 | 4318 | 4572 | 4826 | 5080 |

One end fixed, other end supported



|        |     |     |     |      |      |      |      |      |      |      |      |      |      |      |      |      |      |      |      |      |
|--------|-----|-----|-----|------|------|------|------|------|------|------|------|------|------|------|------|------|------|------|------|------|
| Inches | 12  | 24  | 36  | 48   | 61   | 73   | 85   | 97   | 109  | 121  | 133  | 145  | 158  | 170  | 182  | 194  | 206  | 218  | 230  | 242  |
| mm     | 304 | 609 | 914 | 1219 | 1549 | 1854 | 2159 | 2463 | 2768 | 3073 | 3378 | 3683 | 4013 | 4318 | 4622 | 4927 | 5232 | 5537 | 5842 | 6146 |

Both ends fixed



|        |     |     |      |      |      |      |      |      |      |      |      |      |      |      |      |      |      |      |      |      |
|--------|-----|-----|------|------|------|------|------|------|------|------|------|------|------|------|------|------|------|------|------|------|
| Inches | 15  | 30  | 45   | 60   | 75   | 90   | 105  | 119  | 134  | 149  | 164  | 179  | 194  | 209  | 224  | 239  | 254  | 269  | 284  | 298  |
| mm     | 381 | 762 | 1143 | 1524 | 1905 | 2286 | 2667 | 3022 | 3403 | 3784 | 4165 | 4546 | 4927 | 5308 | 5689 | 6070 | 6451 | 6832 | 7213 | 7594 |

Example: Travel rate of 400 rpm.  
 Unsupported length of 85 in. (2159mm).  
 End fixity of one end fixed, other end supported.

All screws with curves which pass through or above and to the right of the plotted point are suitable for the example. The acceptable velocities shown by this graph apply to the screw shaft selected and are not indicative of the velocities attainable of all of the associated ball nut assemblies. Consult Thomson engineering for high speed applications.

†80% of critical speed

# Engineering Guidelines for Inch Series Ball Screws

## Life Expectancy for Precision Ball Screw Assemblies

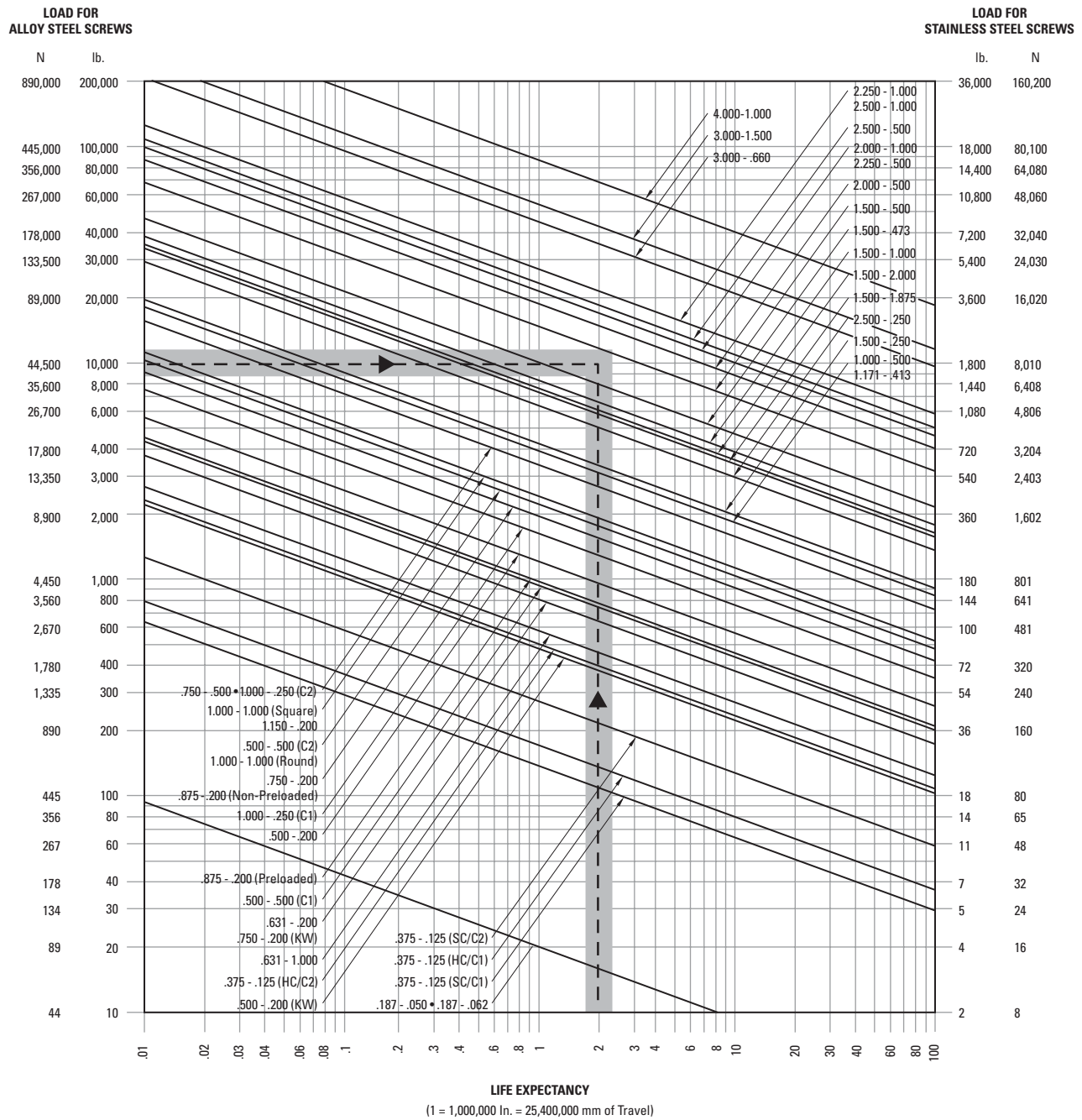

C1 = Single Circuit      C2 = Double Circuit      SC = Standard Capacity      HC = High Capacity

Example: Application life expectancy (total travel) desired is 2 million in. (50.8 million mm).  
Normal operating load is 10,000 lb. (44,500 N).

All screws with curves which pass through or are above and to the right of the plotted point are suitable for the example. The suitable dynamic life expectancies shown in this graph are not to exceed the maximum static load capacity as given in the rating table for the individual ball nut assembly.

# Engineering Guidelines for Inch Series Ball Screws

## Life Expectancy for Precision Plus Preloaded Ball Screw Assemblies

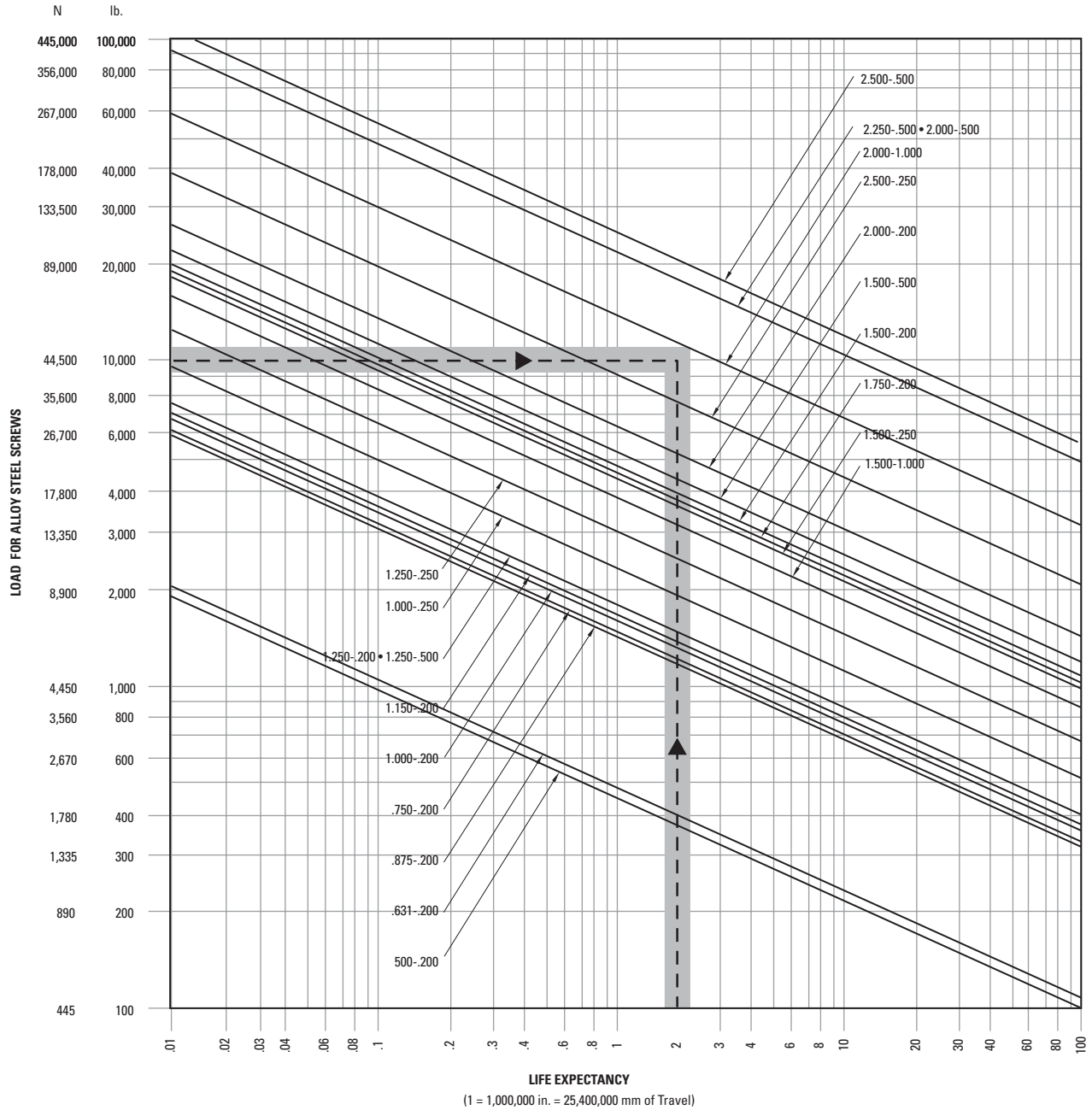

Example: Application life expectancy (total travel) desired is 2 million in. (50.8 million mm).  
Normal operating load is 10,000 lb. (44,500 N).

All screws with curves which pass through or are above and to the right of the plotted point are suitable for the example. The suitable dynamic life expectancies shown in this graph are not to exceed the maximum static load capacity as given in the rating table for the individual ball nut assembly.



# Engineering Guidelines for Inch Series Ball Screws

## Compression Load vs. Length for Designated Ball Screws

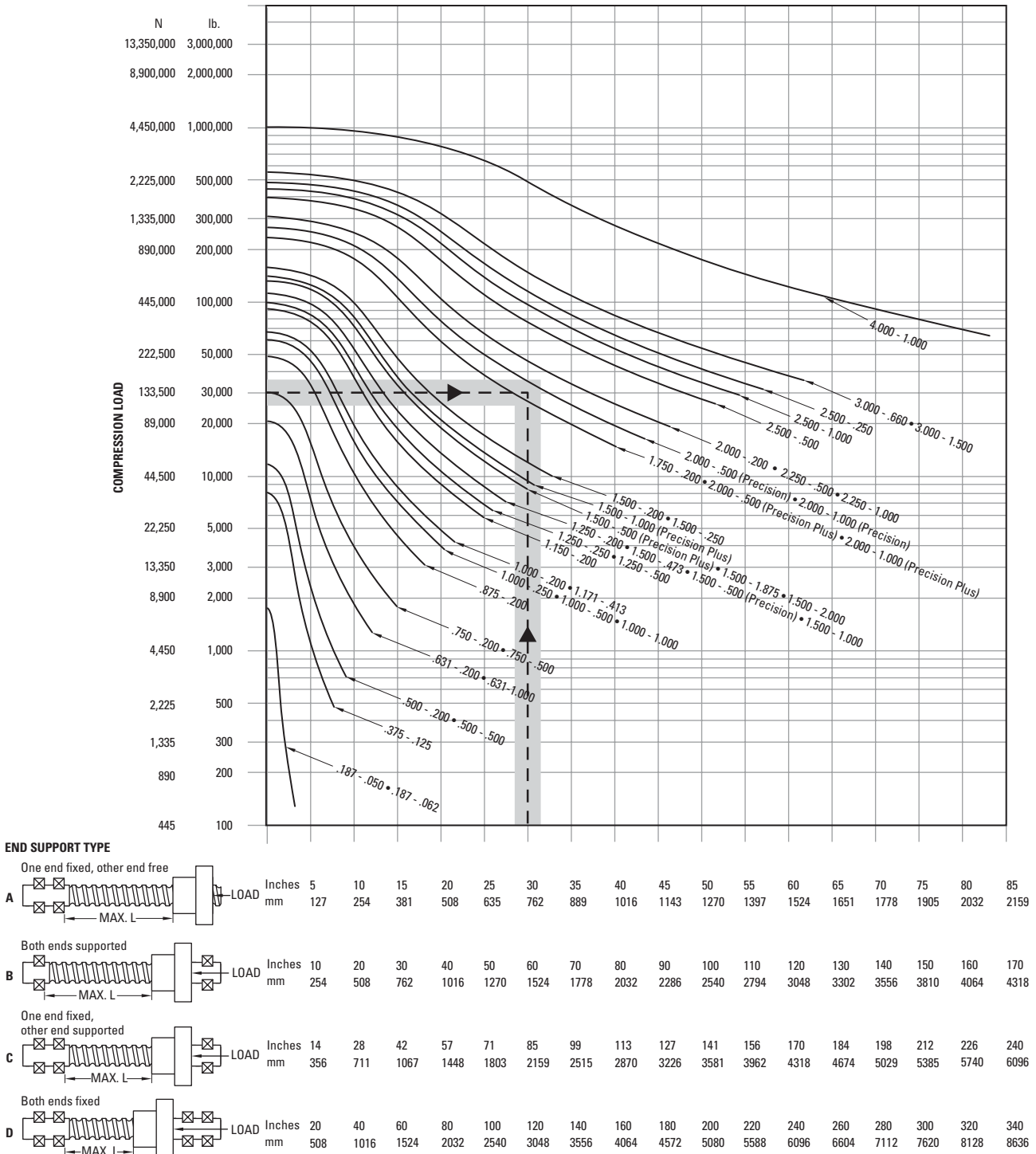

Example: Maximum system load is 30,000 lb. (133,500 N).  
 Length of 85 in. (2159mm).  
 End fixity of one end fixed, other end supported.

All screws with curves which pass through or above and to the right of the plotted point are suitable for the example.

The suitable compression loads shown in this graph are not to exceed the maximum static load capacity as given in the rating table for the individual ball nut assembly.



**NOTES:**

A large rectangular area filled with a light gray grid pattern, intended for handwritten notes.

## Ball Screws — Metric Series Engineering



Need a quote or have a question about an application? Contact us in North America at:

Phone: 540-633-3549

Fax: 540-639-4162

Email: [thomson@thomsonlinear.com](mailto:thomson@thomsonlinear.com)

## Engineering Guidelines for Metric Series Ball Screws

### Selecting a Ball Screw Assembly for Your Application — Metric Series

A ball screw assembly is a mechanical device for translating rotational motion to linear motion. As well as being able to apply or withstand high thrust loads, they can do so with minimum internal friction. They are made to close tolerances and are therefore suitable for use in situations in which high precision is necessary. The selection of the correct ball screw assembly for a specific application is an iterative process to determine the smallest envelope and most cost-effective solution. Below is a list of the most common (but not complete) design considerations used to select a ball screw assembly.

- Compression or Tension Load
- Linear Velocity
- Positional Accuracy and Repeatability
- Required Life Expectancy
- Mounting Configuration
- Dimensional Constraints
- Input Power Requirements
- Environmental Condition

At a minimum, the design load, linear velocity, and positional accuracy should be the known inputs and are used to calculate the diameter, lead, and load capacity of the ball screw assembly. Individual ball screw components are then selected based on life, dimensional constraints, mounting configuration, and environmental conditions.

The following procedure will take you through the most common application-based selection of a ball screw assembly. As no two applications are the same, so the determination process is never the same.

1. Determine the required positional accuracy and repeatability that your application requires (page 208). Backlash is the linear independent motion between the ball screw and the ball nut and can be controlled by preloading the ball nut (page 209). The manufacturing process, rolled screws versus ground screws, dictates the accuracy (page 209).
2. Determine how you plan to mount the ball screw assembly into your machine (see page 197). The configuration of the end supports and the travel distance (Max L) will dictate the load and speed limitations of the ball screw.
3. A ball nut in tension can handle loads up to the rated capacity of the nut. For a ball nut in compression, calculate the Permissible Compression Loading (page 207) or use the Compression Loading Chart (page 212) to select a ball screw diameter that meets or exceeds your design load.
4. Calculate the lead of the ball screw that will produce the speed requirement (page 206).
5. The ball nut life can then be calculated using the Dynamic Load Rating ( $C_{am}$ ) provided in the catalog detail pages. Since multiple ball nuts may be available for a given diameter and lead, use the chart on page 107 to select available styles.
6. Every ball screw has a rotation speed limit, which is the point of excessive vibration/harmonics in the screw. The critical speed is dependent on the end support configuration. Calculate the Critical Screw Speed of the chosen ball screw (page 207) or use the Acceptable Speed Chart (page 211) to determine the critical speed.
7. If the load, life and speed calculations confirm that the selected ball screw assembly meets or exceeds the design requirements, then proceed to the next step. If not... Larger diameter screws will increase the load capacity and increase the speed rating. Smaller lead screws will decrease the linear speed (assuming constant input motor speed), increase the motor speed (assuming constant linear speed), and decrease the input torque required. Higher lead screws will increase the linear speed (assuming constant input motor speed), decrease the input motor speed (assuming constant linear speed), and increase the input torque required. Repeat steps 3 thru 5 until the correct solution is obtained.
8. Determine how the ball nut will interface into your application. A ball nut flange is the typical method of attaching the ball nut to the load. Threaded ball nuts and cylindrical ball nuts are alternative ways to provide the interface.
9. Additional design considerations and features are also available. Preloaded ball nuts are available to reduce system backlash and increase positional accuracy. Wiper kits to protect the assembly from contaminants and to contain lubrication are standard on some units and optional on most others. Bearing supports and end machining are also available as options for all ball screws.
10. The final considerations are system mounting and lubrication. The ball nut should be loaded axially only as any radial loading significantly reduces the performance of the assembly (page 210). The assembly should also be properly aligned with the drive system, bearing supports, and load to achieve optimal performance (page 210). The ball screw assembly should never be run without proper lubrication. Many lubricants are available depending on the application and environment (page 210).

Note: Application and customer service support is available to assist in the selection of your ball screw assembly. Please contact your local Thomson representative or the customer support center (1-540-633-3549 — TCS) for any additional assistance.

## Engineering Guidelines for Metric Series Ball Screws

### Ball Screw Assembly Selection Example:

Inputs:

Load: 133,440 N Compression Maximum  
44,480 N dynamic  
Linear Speed: 5.08 meter/min.  
Input Speed: 400 rpm  
Travel: 2159 mm  
Life:  $2.5 \times 10^4$  meters

#### 1. Accuracy (pages 208 and 209)

No Preload and Standard Rolled ( $\pm 50 \mu\text{m}$  per 300mm)

#### 2. End Supports (page 197)

Fixed/Supported

#### 3. Determine Screw Diameter

From Chart (page 212):  $\varnothing 50\text{mm}$

From Equation (page 207):  $133,440 / .8 = \frac{1.47 \times 9.687 \times 10^4 \times d_r^4}{(2159)^2}$

therefore,  $d_r = 44.8\text{mm}$

#### 4. Determine Lead (pages 206 and 109)

Lead =  $\frac{5.08 \text{ meter/min.}}{400 \text{ rpm}}$  therefore, Lead = 12.7mm, Use 10mm

#### 5. Determine Life

From Catalog (page 122): Dynamic Load = 66,400 N

Life (revolutions) =  $\left[ \frac{66,400}{44,480} \right]^3 \times 10^6$

therefore, Life =  $3.3 \times 10^6$  revs ( $3.3 \times 10^4$  meters)

#### 6. Determine Critical Speed

From Catalog (page 122): Screw Root Diameter is 43.0mm

From Equation (page 207):  $.8 \times 1.47 \times 1.2 \times 10^6 \times \frac{d_r}{l^2}$

therefore, Speed = 1,301.8 rpm

Verified via Chart (page 211)

#### 7. Design Verification

OK per load, speed and life.

#### 8. Load Interface

Flanged connection preferred.

#### 9. Additional Requirements

- Wipers required
- Bearing Supports required
- End Machining needed
- Right Hand Thread
- Carbon Steel

#### 10. Mounting and Lubrication

System will require motor interface and linear rails for alignment.  
TriGel 450R

Product Selection (page 122):

Ball Nut: P/N 7832818

Ball Screw: P/N 7832817-P5

# Engineering Guidelines for Metric Series Ball Screws

## Design Formulas

These formulas allow you to calculate a number of important factors which govern the application of Thomson ball screws.

### 1. Ball Screw Life (L)

The ball screw assembly's useful life will vary according to load and speed. Life is typically rated at 90% confidence, L10 (which represents time at which 90% of assemblies still perform).

Functional life should be determined by approximating equivalent rotational speed and loading force over typical performance cycles.

**Simple rotational speed profile**

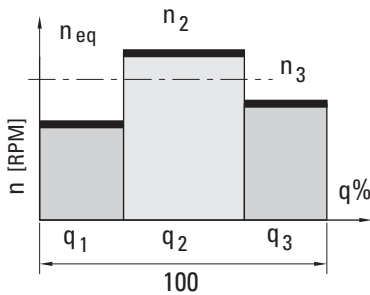

$$n_{eq} [\text{min}^{-1}] = \sum_{i=1}^n n_i \times \frac{q_i}{100}$$

**Simple loading profile (1)**

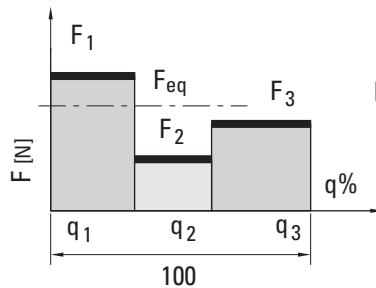

$$F_{eq} [N] = \left( \sum_{i=1}^n F_i^3 \times \frac{n_i}{n_{eq}} \times \frac{q_i}{100} \right)^{1/3}$$

**Simple loading profile (2)**

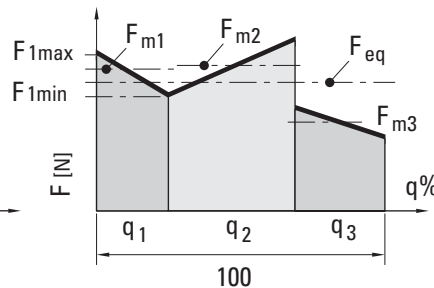

$$F_{eq} [N] = \left( \sum_{i=1}^n F_{mi}^3 \times \frac{n_i}{n_{eq}} \times \frac{q_i}{100} \right)^{1/3}$$

#### Modified Life

$$L_{10} [\text{revolutions}] = \left[ \frac{C_{am}}{F_{eq}} \right]^3 \times 10^6$$

$$L_{h10} [\text{hours}] = \frac{L_{10}}{n_{eq} \times 60}$$

#### Parameters:

- $n_{eq}$  = equivalent operating rotational speed [rpm]
- $F_{eq}$  = equivalent operating load [N]
- $C_{am}$  = dynamic load rating [N] (see specification tables) (Based on 1.0 million revolutions)

### 2. Rotational Speed Required for a Specific Linear Velocity

$$n = \frac{\text{Travel Rate (mm x min.}^{-1}\text{)}}{\text{Lead (mm)}} \quad n = \text{rpm}$$

### 3. Machine Service Life

After ball screw life (L) is calculated, apply it to the following formula to determine machine service life.

$$\text{Machine Service Life (in years)} = \frac{L_{h10} [\text{hours}]}{(\text{machine operating hours}) \cdot (\text{days/year}) \cdot \left( \frac{\text{ball screw operating hours}}{\text{machine operating hours}} \right)}$$

## Engineering Guidelines for Metric Series Ball Screws

### 4. Torque

a. Driving torque:  $T_d \text{ (N}\cdot\text{m)} = \frac{F_{eq} \times P}{2\pi e} = 1.77 \times 10^{-4} \times F_{eq} \times P$

b. Backdrive torque:  $T_b \text{ (N}\cdot\text{m)} = \frac{F_{eq} \times P \times e}{2\pi} = 1.43 \times 10^{-4} \times F_{eq} \times P$

(conversion of linear to rotational motion)

$F_{eq}$  = Equivalent Operating Load (N)  
 $P$  = Lead (mm)  
 $e$  = Efficiency = 0.90  
 $T_d$  = Driving Torque (N•m)  
 $T_b$  = Backdrive Torque (N•m)  
 1 lb-in. = 0.113 N•m

### 5. Power

$P_d \text{ (W)} = \frac{F_{eq} \times P}{(2\pi) e} \times \frac{n}{9.546 \times 10^3} = \frac{F_{eq} \times P \times n}{5.398 \times 10^4}$

$P_d$  = Power (W)  
 $n$  = rpm  
 1 hp = 746 W

### 6. Permissible Rotational Speed

The permissible rotational speed depends on two factors: critical screw speed and critical nut speed.

#### 6a. Critical Screw Speed

The critical screw speed is related to the natural frequency of the screw shaft. Exceeding this value may result in excessive vibration. The critical screw speed may be found using the following equations or the chart on page 209.

$n_c = C_s \times 1.2 \times 10^6 \times \frac{d_r}{l^2}$   $n_c$  = Critical Speed (rpm)  
 $n_s = n_c$   $n_s$  = Safe Drive Speed  
 $d_r = n_c \times S$   $d_r$  = Root Diameter (mm)  
 $l$  = Length between Bearing Supports (mm)  
 $S$  = Safety Factor (0.8 maximum)  
 $C_s$  = End Fixity Factor

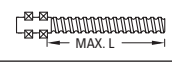
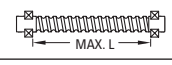
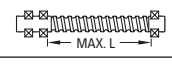
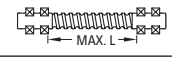
| End Fixity Factor - Critical Screw Speed |   |       |
|--|---|-------|
| End Supports                             |   | $C_s$ |
| A  |  One end fixed, one end free       | 0.36  |
| B  |  Both ends supported              | 1.00  |
| C  |  One end fixed, one end supported | 1.47  |
| D  |  Both ends fixed                  | 2.23  |

#### 6b. Critical Nut Speed

The critical nut speed is related to the velocity of the ball bearings rotating around the screw shaft. Exceeding this value may result in permanent damage to the ball recirculation components. Thomson recommends a maximum DN value of 140,000 for standard internal transfer designs, which encompass the majority of the Metric products. Higher values may be accommodated by special design (consult with applications engineering).

$DN = d_0 n$

where

$d_0$  = nominal shaft diameter (mm)  
 $n$  = rotational speed of shaft (rpm)

### 7. Permissible Compression Loading

Exceeding the recommended maximum compression force may result in buckling of the screw shaft.

$F_c = \frac{C_s \times 9.687 \times 10^4 \times d_r^4}{l^2}$   $F_c$  = Critical Buckling Force (N)  
 $F_s = F_c$   $F_s$  = Safe Compression Force (N)  
 $d_r = F_s \times S$   $d_r$  = Root Diameter (mm)  
 $l = F_s \times S$   $l$  = Max Unsupported Length (mm)  
 $S$  = Safety Factor (0.8 maximum)  
 $C_s$  = End Fixity Factor

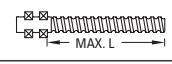
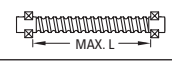
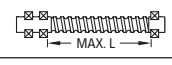
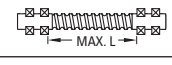
| End Fixity Factor - Permissible Compression Loading |   |       |
|---|---|-------|
| End Supports  |   | $C_s$ |
| A   |  One end fixed, one end free      | 0.25  |
| B   |  Both ends supported              | 1.00  |
| C   |  One end fixed, one end supported | 2.00  |
| D   |  Both ends fixed                  | 4.00  |

# Engineering Guidelines for Metric Series Ball Screws

## Accuracy Classes

Accuracy is a measure of how closely a motion system will approach a command position. Perfect accuracy, for example, means that advancing a ball nut a precise amount from a given point on the screw always requires exactly the theoretically predicted number of revolutions.

Metric ball screws are produced in two main tolerance classes: T (transport) and P (positioning). Transport grade ball screws are used in applications requiring only coarse movement or those utilizing linear feedback for position location. As such, most transport grade screws are provided with nuts having backlash (T7 grade screws cannot be supplied with preloaded nuts). Precision grade ball screws are used where repeatable positioning within microns is critical, without the use of a linear feedback device.

Differences between P & T grades are highlighted in the graph. T grade transport screws allow greater cumulative variation over the useful length of the screw. P grade positioning screws contain accumulation of lead error to provide precise positioning over the screw's entire useful length.

## P — Positioning Class Ball Screws

$$\text{Maximum error over useful length} = e_p + 1/2V_{up} + C$$

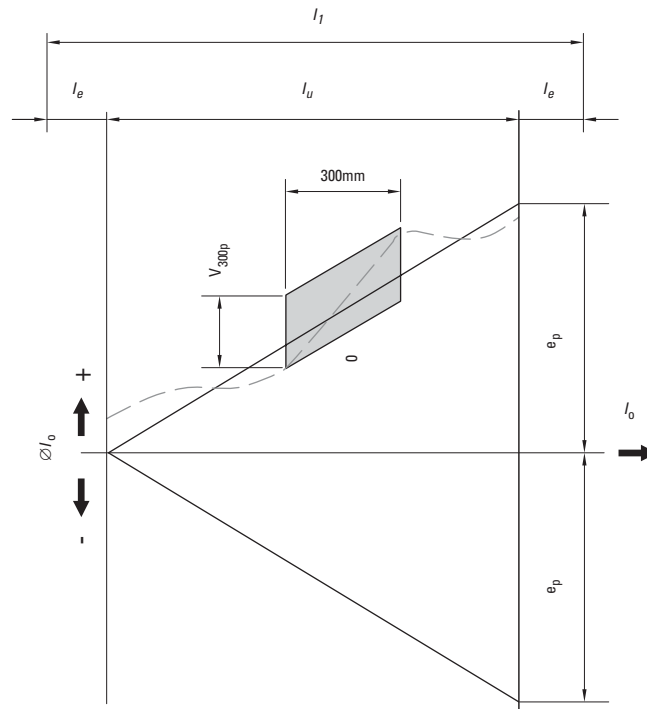
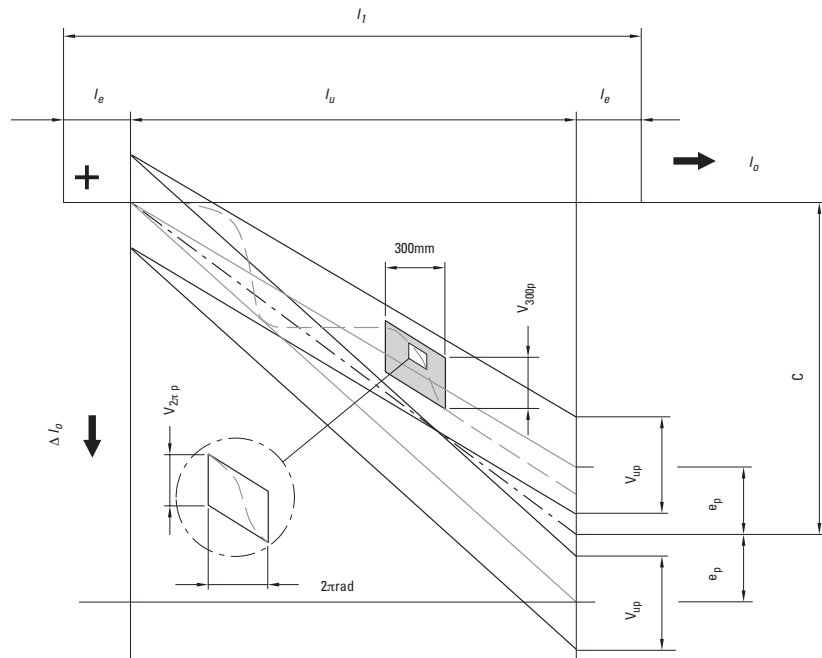

- $l_o$  = nominal travel
- $l_1$  = thread length
- $l_e$  = travel deviation
- $l_u$  = useful travel
- $l_e$  = excess travel
- $C$  = travel compensation for useful travel (std. = 0)
- $e_p$  = tolerance for actual mean travel deviation (the difference between the maximum and minimum values of the permissible actual mean travel)
- $V_{up}$  = permissible travel variation within useful travel,  $l_u$
- $V_{300p}$  = permissible travel deviation within 300mm travel
- $V_{2\pi p}$  = permissible travel deviation within 1 revolution



# Engineering Guidelines for Metric Series Ball Screws

## Permissible Travel Variation Over Usable Length

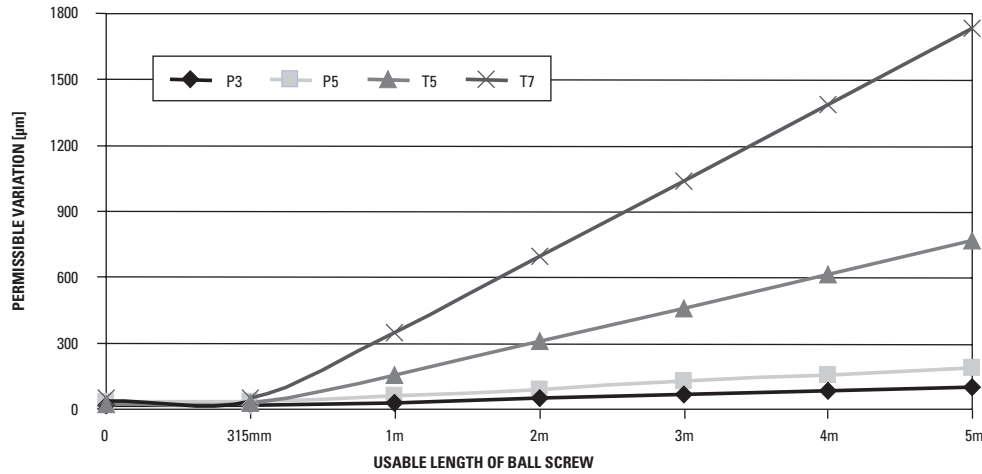

| Tolerance Class | Lead Accuracy $V_{300p}$          | Permissible Travel Deviation $V_{up}$ ( $\mu\text{m}$ ) Over Screw Length $l_u$ (mm) |    |  |     |     |     |     |      |      |      |      |      |      |      |      |      |
|-----------------|-----------------------------------|--|----|--|-----|-----|-----|-----|------|------|------|------|------|------|------|------|------|
|                 |                                   | $l_u$  | >  |  | 315 | 400 | 500 | 630 | 800  | 1000 | 1250 | 1600 | 2000 | 2500 | 3150 | 4000 | 5000 |
|                 |                                   | (mm)   | ?  | 315                                    | 400 | 500 | 630 | 800 | 1000 | 1250 | 1600 | 2000 | 2500 | 3150 | 4000 | 5000 | 6300 |
| P3              | $\pm 12 \mu\text{m}/300\text{mm}$ | $e_p$ ( $\mu\text{m}$ )  | 12 | 13                                     | 15  | 16  | 18  | 21  | 24   | 29   | 35   | 41   | 50   | 62   | 76   | —    | —    |
|                 |                                   | $V_{up}$ ( $\mu\text{m}$ )   | 12 | 12                                     | 13  | 14  | 16  | 17  | 19   | 22   | 25   | 29   | 34   | 41   | 49   | —    | —    |
| P5              | $\pm 23 \mu\text{m}/300\text{mm}$ | $e_p$ ( $\mu\text{m}$ )  | 23 | 25                                     | 27  | 30  | 35  | 40  | 46   | 54   | 65   | 77   | 93   | 115  | 140  | 170  | —    |
|                 |                                   | $V_{up}$ ( $\mu\text{m}$ )   | 23 | 25                                     | 26  | 29  | 31  | 35  | 39   | 44   | 51   | 59   | 69   | 82   | 99   | 119  | —    |
| T5              | $\pm 23 \mu\text{m}/300\text{mm}$ | $V_{up}$ ( $\mu\text{m}$ )   | 23 | $= 2 \times l_u / 300 \times V_{300p}$ |     |     |     |     |      |      |      |      |      |      |      |      |      |
| T7              | $\pm 52 \mu\text{m}/300\text{mm}$ | $V_{up}$ ( $\mu\text{m}$ )   | 52 | $= 2 \times l_u / 300 \times V_{300p}$ |     |     |     |     |      |      |      |      |      |      |      |      |      |

## Preload Types

**Precise Preload (Type Z0)**  
(Available with FL nut only)

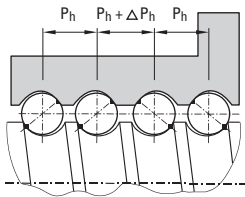

- The lead is offset within the ball nut to provide a precise preload.
- The preload is approximately 10% of dynamic load capacity, but can range from 2% to 13% as specified by customers.
- Typically used where both repeatability and high stiffness are required.

**Preload (Type Z1)**

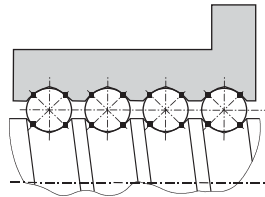

- Oversized balls slightly larger than the ball groove space are used to provide zero backlash between the screw and nut.
- The preload is approximately 1% to 2% of dynamic load capacity.
- Typically used for positioning applications where higher-level repeatability is desired.

**No Preload (Type Z2)**  
(Standard lash)

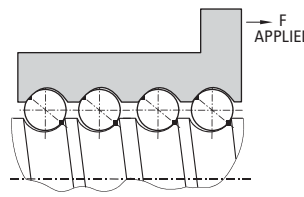

- Axial play is present between screw and nut.
- Typically used for transport or vertical applications.

**No Preload (Type Z3)**  
(Minimum lash)

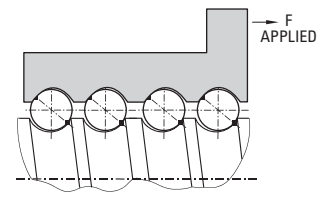

- Axial play is present between screw and nut (held to .05mm maximum).
- Typically used for transport or vertical applications.

## Engineering Guidelines for Metric Series Ball Screws

### Lubrication Guidelines

Ball screws must be lubricated to operate properly and achieve the rated life. We recommend using TriGEL-450R or TriGEL-1800RC for lubricating ball screws. Other oils and greases may be applicable but have not been evaluated.

The TriGEL grease can be applied directly to the screw threads near the root of the ball track. Some ball nut sizes are available with threaded lube holes for mounting lubrication fittings. For these ball nuts, the TriGEL grease can be pumped directly into the nut. Please refer to the catalog detail views to verify which ball nuts have the threaded lube holes. It is recommended to use these nuts in conjunction with a wiper kit to contain the lubricant in the body of the nut.

Ball screws may require lubrication frequently depending on both environmental and operating conditions. If the lubricant appears to be dispersed before this point or has become dry or crusted, the maintenance



interval should be reduced. Before adding additional grease, wipe the screw clean, removing the old grease and any particulate contamination seen on the screw. If oil is

being used, the best results may be obtained by utilizing a continuous-drip type applicator.

### Nut Loading

Axial loading (on nut or screw) is optimal for performance and life. For applications requiring radial loads, please contact us.

Axial Loading: optimal

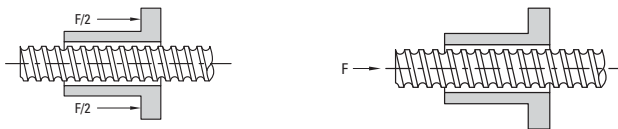

Radial Loading: detrimental\*



\* Minimize radial loading to less than 5% of the axial load.

### Nut Mounting

Use the following guidelines to achieve optimal performance. (All units are mm)

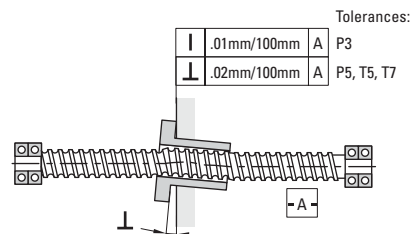
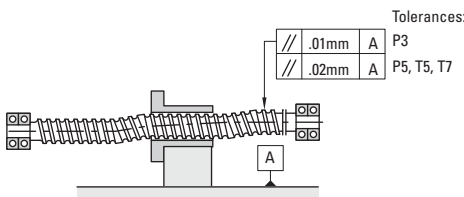

# Engineering Guidelines for Metric Series Ball Screws

## Acceptable Speed† vs. Length for Screws

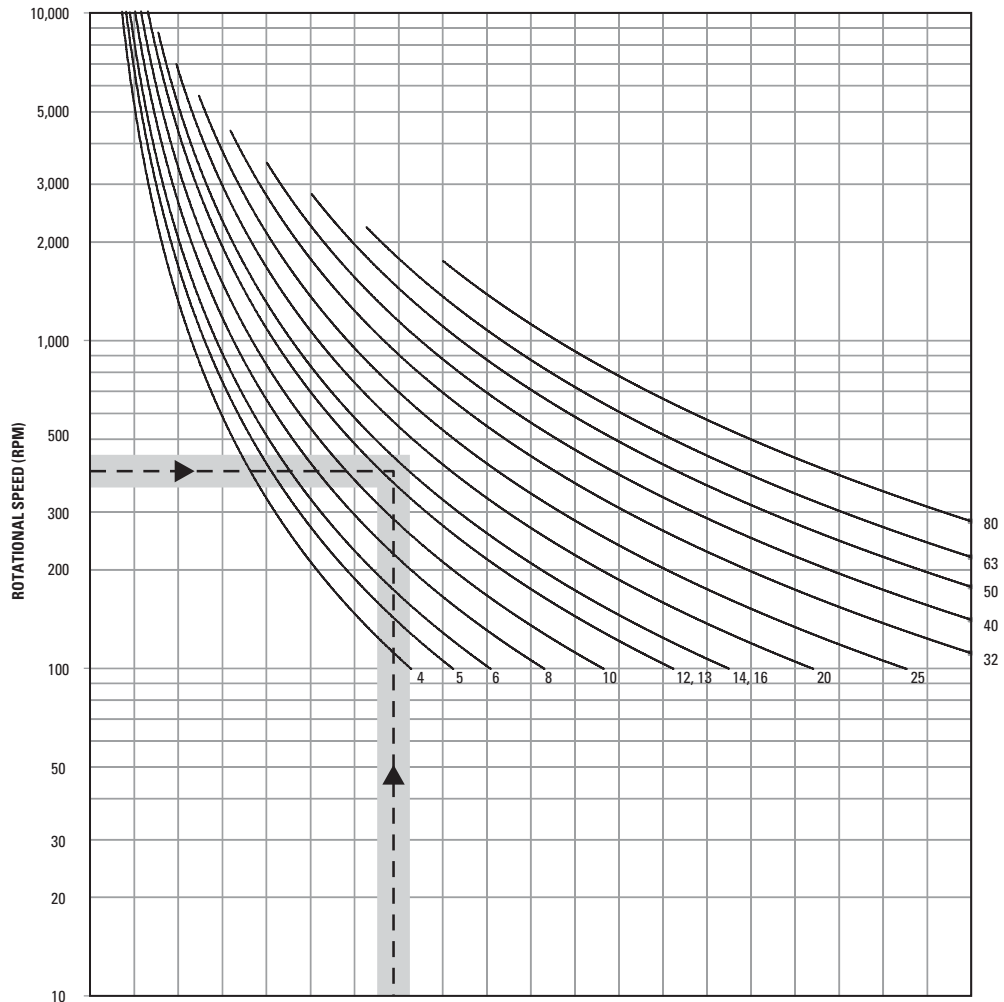

**END SUPPORT TYPE**

| Support Type | Diagram                            | Inches | 6   | 12  | 18   | 24   | 30   | 36   | 42   | 48   | 54   | 60   | 66   | 72   | 78   | 84   | 90   | 96   | 102  | 108  | 114  | 120  |
|--------------|------------------------------------|--------|-----|-----|------|------|------|------|------|------|------|------|------|------|------|------|------|------|------|------|------|------|
| A            | One end fixed, other end free      | mm     | 152 | 304 | 457  | 609  | 762  | 914  | 1056 | 1219 | 1371 | 1524 | 1676 | 1828 | 1981 | 2133 | 2286 | 2438 | 2590 | 2743 | 2895 | 3048 |
| B            | Both ends supported                | Inches | 10  | 20  | 30   | 40   | 50   | 60   | 70   | 80   | 90   | 100  | 110  | 120  | 130  | 140  | 150  | 160  | 170  | 180  | 190  | 200  |
|              |                                    | mm     | 254 | 508 | 762  | 1016 | 1270 | 1524 | 1778 | 2032 | 2286 | 2540 | 2794 | 3048 | 3302 | 3556 | 3810 | 4064 | 4318 | 4572 | 4826 | 5080 |
| C            | One end fixed, other end supported | Inches | 12  | 24  | 36   | 48   | 61   | 73   | 85   | 97   | 109  | 121  | 133  | 145  | 158  | 170  | 182  | 194  | 206  | 218  | 230  | 242  |
|              |                                    | mm     | 304 | 609 | 914  | 1219 | 1549 | 1854 | 2159 | 2463 | 2768 | 3073 | 3378 | 3683 | 4013 | 4318 | 4622 | 4927 | 5232 | 5537 | 5842 | 6146 |
| D            | Both ends fixed                    | Inches | 15  | 30  | 45   | 60   | 75   | 90   | 105  | 119  | 134  | 149  | 164  | 179  | 194  | 209  | 224  | 239  | 254  | 269  | 284  | 298  |
|              |                                    | mm     | 381 | 762 | 1143 | 1524 | 1905 | 2286 | 2667 | 3022 | 3403 | 3784 | 4165 | 4546 | 4927 | 5308 | 5689 | 6070 | 6451 | 6832 | 7213 | 7569 |

Unsupported length of 85 in. (2159mm).

End fixity of one end fixed, other end supported.

All screws with curves which pass through or above and to the right of the plotted point are suitable for the example. The acceptable velocities shown by this graph apply to the screw shaft selected and are not indicative of the velocities attainable of all of the associated ball nut assemblies. Consult Thomson engineering for high speed applications.

†80% of critical speed

# Engineering Guidelines for Metric Series Ball Screws

## Compression Load vs. Length for Designated Ball Screws

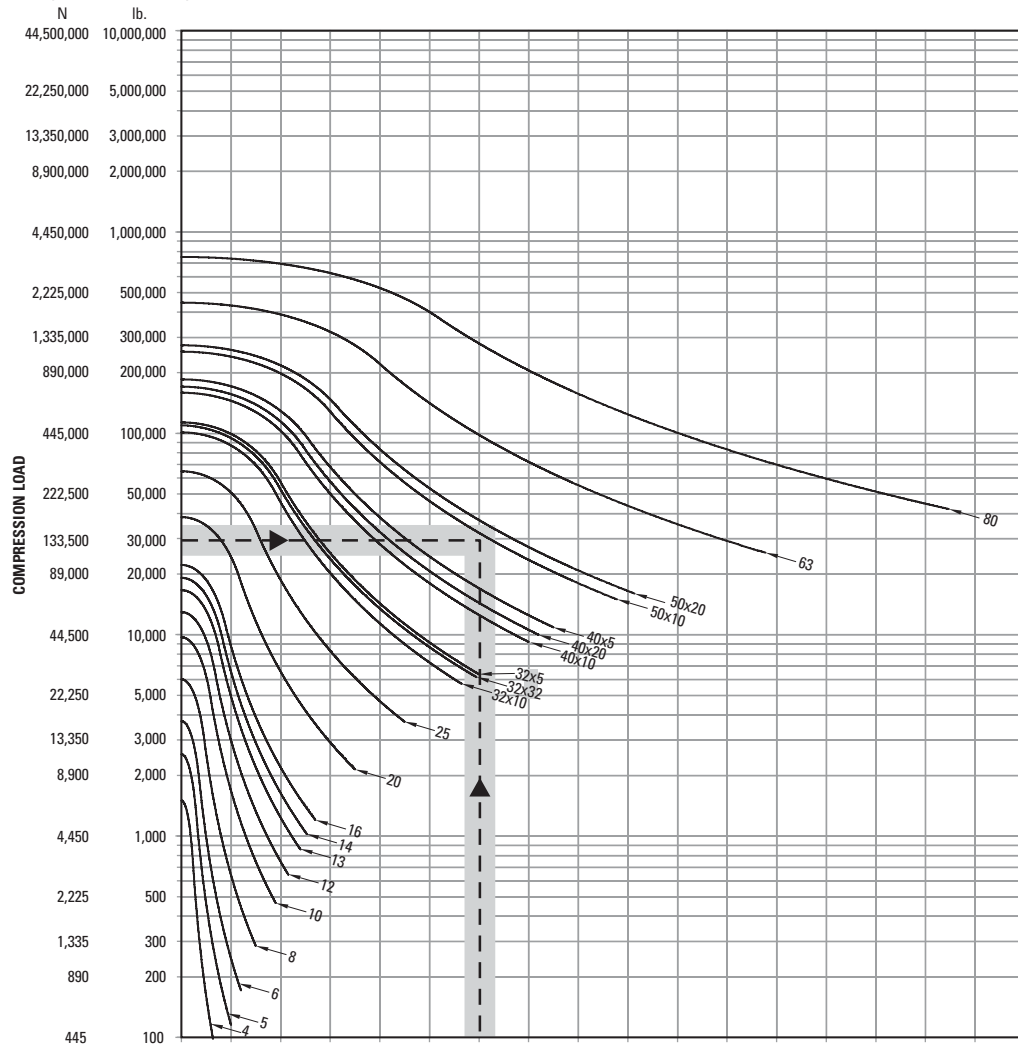

**END SUPPORT TYPE**

| Support Type                                | Inches | 5   | 10   | 15   | 20   | 25   | 30   | 35   | 40   | 45   | 50   | 55   | 60   | 65   | 70   | 75   | 80   | 85   |
|---|--------|-----|------|------|------|------|------|------|------|------|------|------|------|------|------|------|------|------|
| <b>A</b> One end fixed, other end free      | mm     | 127 | 254  | 381  | 508  | 635  | 762  | 889  | 1016 | 1143 | 1270 | 1397 | 1524 | 1651 | 1778 | 1905 | 2032 | 2159 |
| <b>B</b> Both ends supported                | Inches | 10  | 20   | 30   | 40   | 50   | 60   | 70   | 80   | 90   | 100  | 110  | 120  | 130  | 140  | 150  | 160  | 170  |
|   | mm     | 254 | 508  | 762  | 1016 | 1270 | 1524 | 1778 | 2032 | 2286 | 2540 | 2794 | 3048 | 3302 | 3556 | 3810 | 4064 | 4318 |
| <b>C</b> One end fixed, other end supported | Inches | 14  | 28   | 42   | 57   | 71   | 85   | 99   | 113  | 127  | 141  | 156  | 170  | 184  | 198  | 212  | 226  | 240  |
|   | mm     | 356 | 711  | 1067 | 1448 | 1803 | 2159 | 2515 | 2870 | 3226 | 3581 | 3962 | 4318 | 4674 | 5029 | 5385 | 5740 | 6096 |
| <b>D</b> Both ends fixed                    | Inches | 20  | 40   | 60   | 80   | 100  | 120  | 140  | 160  | 180  | 200  | 220  | 240  | 260  | 280  | 300  | 320  | 340  |
|   | mm     | 508 | 1016 | 1524 | 2032 | 2540 | 3048 | 3556 | 4064 | 4572 | 5080 | 5588 | 6096 | 6604 | 7112 | 7620 | 8128 | 8636 |

Example: Maximum system load is 30,000 lb. (133,500 N).  
 Length of 85 in. (2159mm).  
 End fixity of one end fixed, other end supported.

All screws with curves which pass through or above and to the right of the plotted point are suitable for the example.

The suitable compression loads shown in this graph are not to exceed the maximum static load capacity as given in the rating table for the individual ball nut assembly.

## Ball Splines — Engineering



Need a quote or have a question about an application? Contact us in North America at:

Phone: 540-633-3549

Fax: 540-639-4162

Email: [thomson@thomsonlinear.com](mailto:thomson@thomsonlinear.com)

## Engineering Guidelines for Ball Splines

### Selection Procedures

**Applications Analysis** — Follow this step-by-step procedure to determine the ball spline best suited for your application. It is suggested you analyze the requirements of your application using a work pad for easy reference.

**Maximum Static Load** — Determine the maximum static torque loads encountered in the application. This must include shock loads. Using the table on page 140, note the ball spline sizes and race combinations which have capacities in excess of the application requirements.

**Rated Load** — In many ball spline applications, freedom of axial movement is essential while actual travel is negligible. For example, a spline used on a jet engine accessory gear box drive moves less than 1/10 inch. This axial freedom is essential to eliminate damaging stress forces to the engine and gear box housings, but total daily travel may be less than 2 inches. Select the size and race combination with a rated load that will meet your application requirement from the table.

**Life Expectancy** — On occasion, it is important to plan for a specific life expectancy. These applications usually are designed to use the smallest practical ball spline at the maximum possible torque or where considerable translation occurs. For these applications, use the Life Expectancy chart on page 215. Contact Thomson if light weight and small size are considerations.

Determine the following:

- life expectancy — total inches of travel desired during the life of the application
- application load — the normal operating load for the application in inch-pounds (Newton-millimeters) of torque

**Speed vs. Length** — Determine the following:

- Speed — determine the maximum revolutions per minute (rpm) required
- Maximum length — determine the maximum unsupported length
- End fixity — determine the type of configuration (refer to the Bearing Support reference drawings on page 197). Quick Mount bearing support blocks can be used on diameters 5/8 inch through 2-1/2 inch. Using the example at the bottom of the Speed vs. Length chart on page 216, plot the point for your specific application.

### Design Formulas

#### Life Ratings

$$L_{10} [\text{in.}] = \left[ \frac{C_{am}}{T} \right]^3 \times 10^6$$





Parameters:

$T$  = dynamic equivalent torque  
(A constant torque under the influence of which a ball spline assembly would have the same life as it will attain under the actual applied torque condition.)

$C_{am}$  = dynamic load rating [lbs.]  
(based on 1.0 million inches)

$$n_c = C_s \times 4.76 \times 10^6 \times \frac{d_r}{l^2}$$

$n_c$  = Critical Speed (rpm)  
 $n_s$  = Safe Drive Speed  
 $d_r$  = Root Diameter (in.)  
 $l$  = Length between Bearing Supports (in.)  
 $S$  = Safety Factor (0.8 maximum)  
 $C_s$  = End Fixity Factor

| End Fixity Factor |   |       |
|-------------------|---|-------|
| End Supports      |   | $C_s$ |
| A                 |  One end fixed, one end free      | 0.36  |
| B                 |  Both ends supported              | 1.00  |
| C                 |  One end fixed, one end supported | 1.47  |
| D                 |  Both ends fixed                  | 2.23  |

# Engineering Guidelines for Ball Splines

## Life Expectancy for Precision Ball Splines

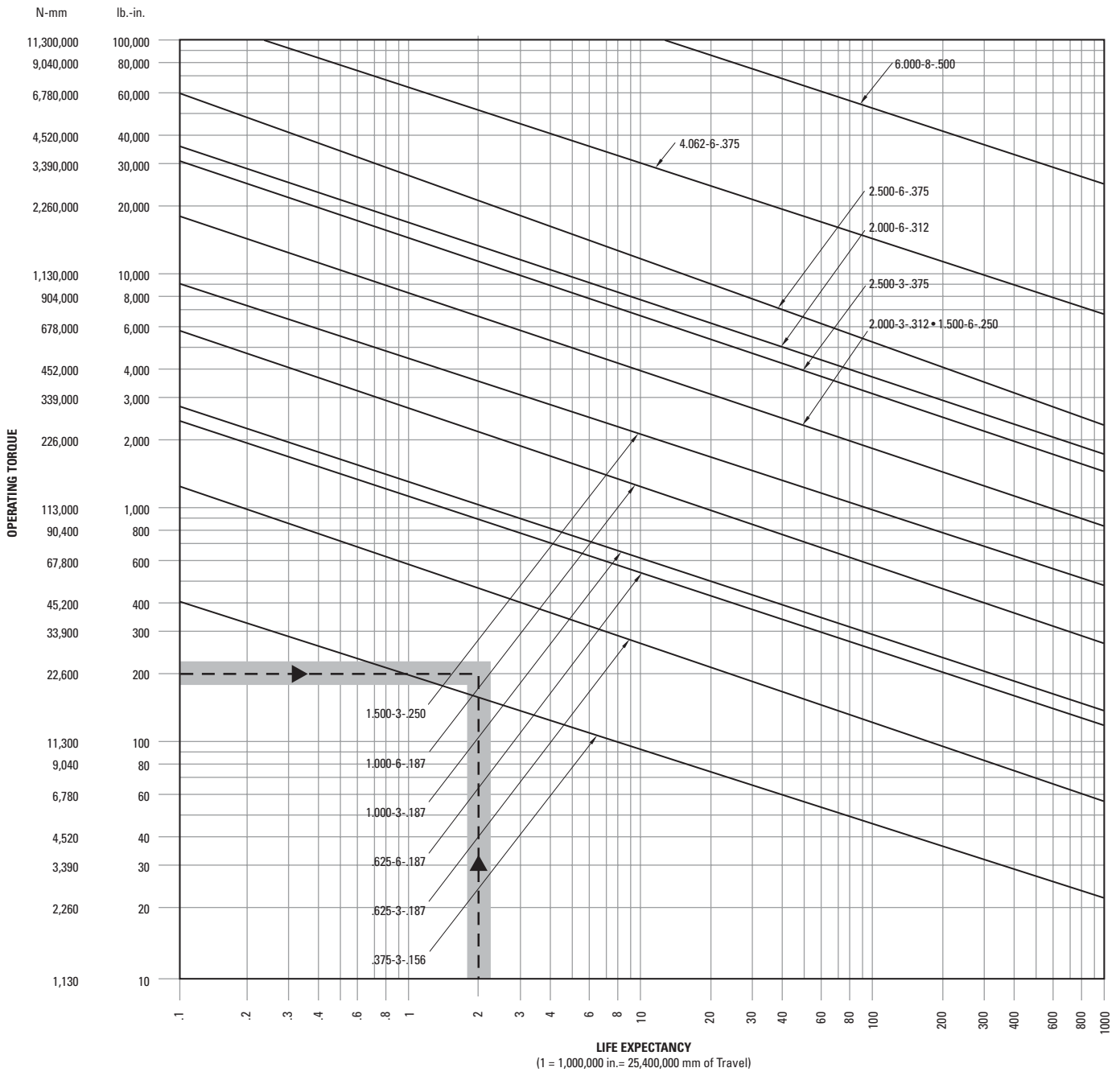

Example: Desired life of 2 million in.  
 (50.8 million mm).  
 Operating torque is 200 lb·in.  
 (22.6 N · mm)

All splines with curves which pass through or are above and to the right of the plotted point are suitable for the example.

# Engineering Guidelines for Ball Splines

## Speed vs. Length for Precision Ball Splines

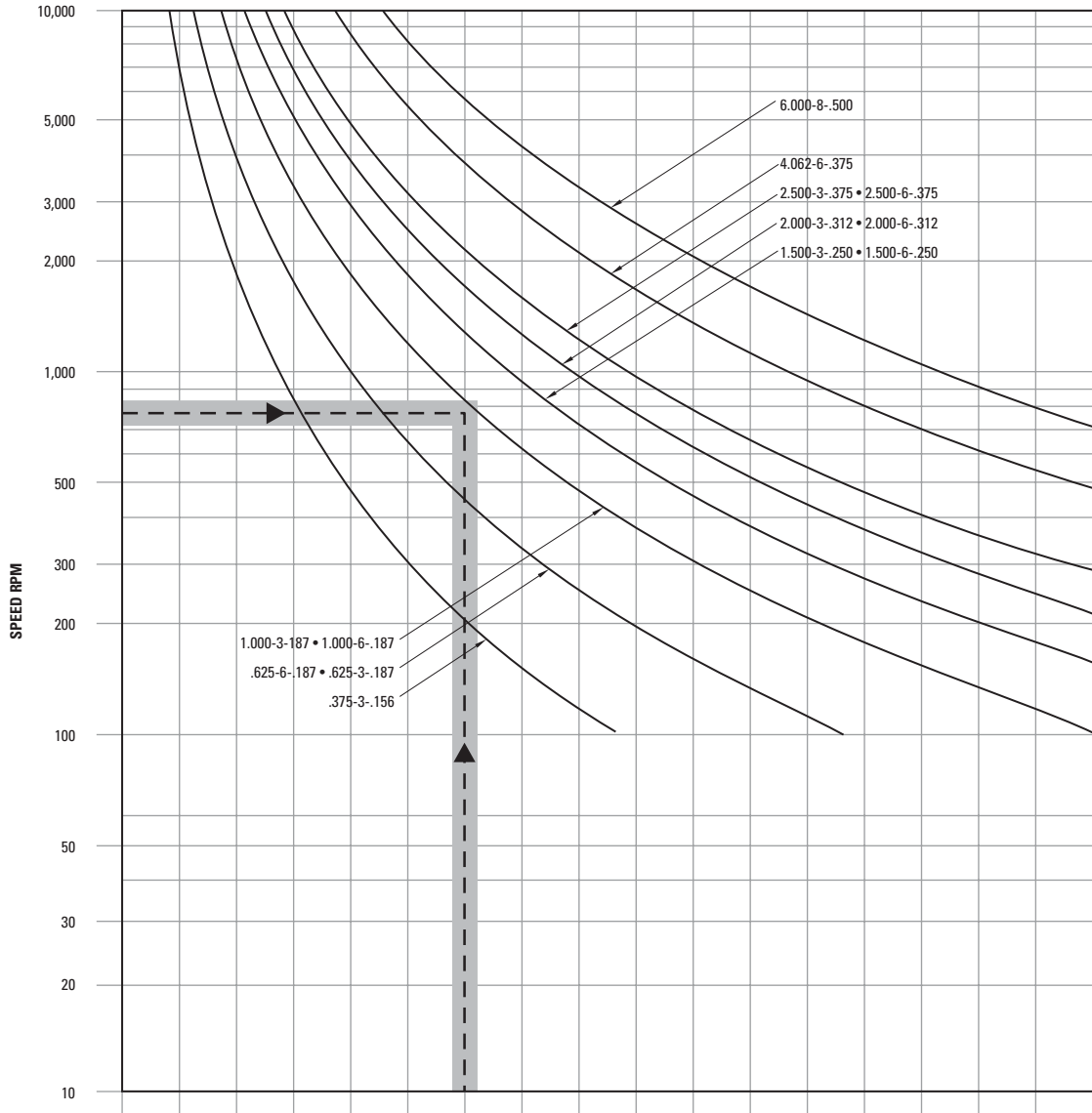

### END SUPPORT TYPE

| Support Type                          | Series | 6 in | 12 in | 18 in | 24 in | 30 in | 36 in | 42 in | 48 in | 54 in | 60 in | 66 in | 72 in | 78 in | 84 in | 90 in | 96 in | 102 in |
|---------------------------------------|--------|------|-------|-------|-------|-------|-------|-------|-------|-------|-------|-------|-------|-------|-------|-------|-------|--------|
| A: One end fixed, other end free      | Inches | 6    | 12    | 18    | 24    | 30    | 36    | 42    | 48    | 54    | 60    | 66    | 72    | 78    | 84    | 90    | 96    | 102    |
|                                       | mm     | 152  | 304   | 457   | 609   | 762   | 914   | 1056  | 1219  | 1371  | 1524  | 1676  | 1828  | 1981  | 2133  | 2286  | 2438  | 2590   |
| B: Both ends supported                | Inches | 10   | 20    | 30    | 40    | 50    | 60    | 70    | 80    | 90    | 100   | 110   | 120   | 130   | 140   | 150   | 160   | 170    |
|                                       | mm     | 254  | 508   | 762   | 1016  | 1270  | 1524  | 1778  | 2032  | 2286  | 2743  | 2794  | 3048  | 3302  | 3556  | 3810  | 4064  | 4318   |
| C: One end fixed, other end supported | Inches | 12   | 24    | 36    | 48    | 61    | 73    | 85    | 97    | 109   | 121   | 133   | 145   | 158   | 170   | 182   | 194   | 206    |
|                                       | mm     | 304  | 609   | 914   | 1219  | 1549  | 1854  | 2159  | 2463  | 2768  | 3073  | 3378  | 3683  | 4013  | 4318  | 4622  | 4927  | 5232   |
| D: Both ends fixed                    | Inches | 15   | 30    | 45    | 60    | 75    | 90    | 105   | 119   | 134   | 149   | 164   | 179   | 194   | 209   | 224   | 239   | 254    |
|                                       | mm     | 381  | 762   | 1143  | 1524  | 1905  | 2286  | 2667  | 3022  | 3403  | 3784  | 4165  | 4546  | 4927  | 5308  | 5689  | 6070  | 6451   |

Example: Maximum shaft speed is 800 rpm.  
 Unsupported length is 60 in. (1524mm).  
 End fixity is both ends supported.

All splines with curves which pass through or are above and to the right of the plotted point are suitable for the example.



## Installation

This section is organized so that the installer can follow step by step instructions to prepare and install a new ball screw assembly. Ball screw assemblies are offered in several variations, so all of the installation steps may not be followed for a specific type. The Glossary of Terms will define any terms with which the user may not be familiar. All product specifications and dimensions are found in this catalog.

### Installation Can Be Completed in Six Easy Steps

- STEP ONE: Mounting the Flange to the Ball Nut  
 STEP TWO: Mount Front End of Wiper to the Screw (brush type wipers only)  
 STEP THREE: Install Ball Nut onto the Ball Screw  
 STEP FOUR: Complete Installation of the Wiper Kit  
 STEP FIVE: Lubricate the Ball Nut and Screw  
 STEP SIX: Install Ball Screw Assembly into Your Machine

Ball screws are delivered to the user in one of four ways:

1. Finished ends with assembled ball nut, ready to mount in a machine. No further preparation is required.
2. Screw ends machined and ball nut supplied on an arbor ready for transfer.
3. Screw cut and annealed ready for machining and ball nut supplied on an arbor ready for transfer.
4. Hardened screw in bulk length with ball nut supplied on an arbor ready for transfer.

Ball nuts are delivered without flanges attached and without lubrication. **Ball screw assemblies must not be run without proper lubrication.**

### STEP ONE: Mounting the Flange to the Ball Nut

*If flange is not used, proceed to STEP TWO.*

#### Preparation of Ball Nut

A ball nut flange is the recommended means of attaching a ball nut to a load. A flange should be tightened firmly against the ball nut on its threads and secured by one of the methods described below. Take care not to grasp and damage the return tubes when tightening the flange. Ball circulation will be impaired if the return tubes are damaged.

Flanges are provided loose from the factory unless otherwise specified. The standard method to secure the flange to the ball nut is shown in Method "A" (retain with pins). Smaller ball screw assemblies may be assembled using Method "B" (retain with set screws). Flanges can be pinned at the factory upon request.

#### Flange Installation Method A

##### Retain with pins (recommended)

1. Remove the ball nut from the transfer arbor. Catch and save the balls for reassembly.
2. Apply Loctite grade 271 (red in color) to the ball nut V-threads.
3. Thread the flange onto the ball nut until it contacts the ball nut shoulder.
4. Loosen the flange until the required machine bolts can be inserted into the flange mounting holes without interfering with the ball return guides (see Figure 1).
5. Drill two holes approximately 90° apart, as shown in Figure 1. Note: the pin circle diameter is also the V-thread pitch diameter.
6. Press two groove type pins to the bottom of the drilled holes.
7. Stake the pin holes to prevent the pins from disengaging.
8. Remove all chips from the ball nut, and clean it thoroughly to remove potential contaminants.
9. Reassemble the flanged ball nut and components on the transfer arbor or ball screw.

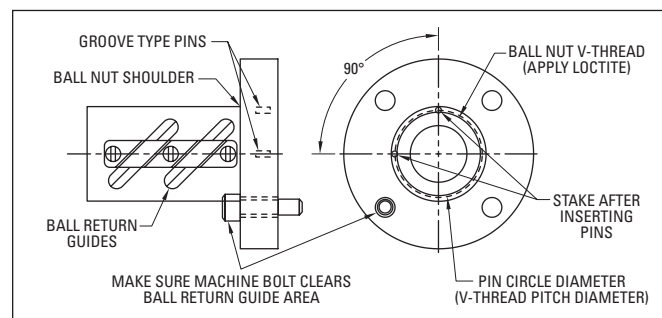

Figure 1

## Installation

### Flange Installation Method B

#### Retain with set screws (optional for flanges with set screws)

1. Apply Loctite grade 271 (red in color) to the ball nut V-threads.
2. Thread the flange onto the ball nut until it contacts the ball nut shoulder.
3. Loosen the flange until the required machine bolts can be inserted into the flange mounting holes without interfering with the ball return guides (see Figure 2).
4. Apply Loctite grade 271 (red in color) to the radial threaded hole in the flange.
5. Select a cup point set screw with a length of one half the threaded hole depth. Install two set screws, tightening to the manufacturer's recommended torque (see Figure 2).

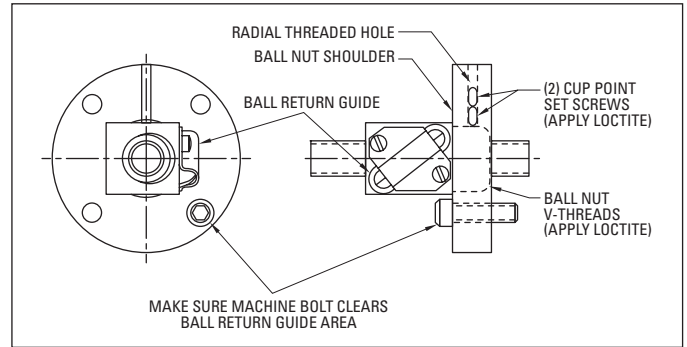

Figure 2

### Method B Dimensions

| V-Thread       | Reference |       |               | Pin Circle Diameter                   | Drill    |       | Pin      |        |       |       |       |       |       |
|----------------|-----------|-------|---------------|---------------------------------------|----------|-------|----------|--------|-------|-------|-------|-------|-------|
|                | BCD       | Lead  | Ball Diameter |                                       | Diameter | Depth | Diameter | Length |       |       |       |       |       |
| .664-32 UNS    | 0.375     | 0.125 | 0.063         | Use Method A — Retain with set screws |          |       |          |        |       |       |       |       |       |
| 0.6875-24 UNEF | 0.375     | 0.125 | 0.063         |                                       |          |       |          |        |       |       |       |       |       |
| 0.9375-16 UN   | 0.500     | 0.200 | 0.125         |                                       |          |       |          |        |       |       |       |       |       |
| 0.9375-16 UN   | 0.500     | 0.500 | 0.125         |                                       |          |       |          |        |       |       |       |       |       |
| 0.9375-16 UN   | 0.631     | 0.200 | 0.125         |                                       |          |       |          |        |       |       |       |       |       |
| 0.9375-16 UN   | 0.631     | 1.000 | 0.125         |                                       |          |       |          |        |       |       |       |       |       |
| 1.173-18 UNS   | 0.750     | 0.200 | 0.125         |                                       |          |       |          |        |       |       |       |       |       |
| 1.125-18 UNEF  | 0.750     | 0.200 | 0.125         |                                       |          |       |          |        |       |       |       |       |       |
| 1.250-18 UNEF  | 0.750     | 0.200 | 0.125         |                                       |          |       |          |        |       |       |       |       |       |
| 1.173-18 UNS   | 0.750     | 0.500 | 0.156         |                                       |          |       |          |        |       |       |       |       |       |
| 1.250-16 UN    | 0.750     | 0.500 | 0.156         |                                       |          |       |          |        |       |       |       |       |       |
| 1.375-16 UN    | 0.875     | 0.200 | 0.125         |                                       |          |       |          |        | 1.332 | 0.094 | 0.312 | 0.094 | 0.250 |
| 1.563-18 UNEF  | 1.000     | 0.250 | 0.156         |                                       |          |       |          |        | 1.527 | 0.125 | 0.438 | 0.125 | 0.375 |
| 1.563-18 UNEF  | 1.000     | 0.500 | 0.156         |                                       |          |       |          |        | 1.527 | 0.125 | 0.438 | 0.125 | 0.375 |
| 1.563-18 UNEF  | 1.000     | 1.000 | 0.156         |                                       |          |       |          |        | 1.527 | 0.125 | 0.438 | 0.125 | 0.375 |
| 1.625-20 UN    | 1.150     | 0.200 | 0.125         | 1.591                                 | 0.094    | 0.312 | 0.094    | 0.250  |       |       |       |       |       |
| 1.967-18 UNS   | 1.171     | 0.413 | 0.281         | 1.929                                 | 0.188    | 0.438 | 0.188    | 0.375  |       |       |       |       |       |
| 1.967-18 UNS   | 1.500     | 0.250 | 0.156         | 1.929                                 | 0.125    | 0.312 | 0.125    | 0.250  |       |       |       |       |       |
| 2.548-18 UNS   | 1.500     | 0.473 | 0.344         | 2.509                                 | 0.250    | 0.438 | 0.250    | 0.375  |       |       |       |       |       |
| 2.360-18 UNS   | 1.500     | 0.500 | 0.312         | 2.337                                 | 0.250    | 0.438 | 0.250    | 0.375  |       |       |       |       |       |
| 2.250-20 UN    | 1.500     | 1.000 | 0.344         | 2.215                                 | 0.250    | 0.562 | 0.250    | 0.500  |       |       |       |       |       |
| 2.250-20 UN    | 1.500     | 1.875 | 0.281         | 2.215                                 | 0.188    | 0.562 | 0.188    | 0.500  |       |       |       |       |       |
| 2.250-20 UN    | 1.500     | 2.000 | 0.281         | 2.215                                 | 0.188    | 0.562 | 0.188    | 0.500  |       |       |       |       |       |
| 3.000-12 UN    | 2.000     | 0.500 | 0.375         | 2.944                                 | 0.250    | 1.000 | 0.250    | 0.625  |       |       |       |       |       |
| 3.000-12 UN    | 2.000     | 1.000 | 0.375         | 2.944                                 | 0.250    | 1.000 | 0.250    | 0.625  |       |       |       |       |       |
| 3.137-12 UNS   | 2.250     | 0.500 | 0.375         | 3.080                                 | 0.250    | 1.000 | 0.250    | 0.625  |       |       |       |       |       |
| 3.137-12 UNS   | 2.250     | 1.000 | 0.375         | 3.080                                 | 0.250    | 1.000 | 0.250    | 0.625  |       |       |       |       |       |
| 3.340-12 UNS   | 2.500     | 0.250 | 0.156         | 3.283                                 | 0.125    | 0.750 | 0.125    | 0.500  |       |       |       |       |       |
| 3.625-12 UN    | 2.500     | 0.500 | 0.375         | 3.443                                 | 0.250    | 1.000 | 0.250    | 0.625  |       |       |       |       |       |
| 3.625-12 UN    | 2.500     | 1.000 | 0.375         | 3.443                                 | 0.250    | 1.000 | 0.250    | 0.625  |       |       |       |       |       |
| 4.325-12 UNS   | 3.000     | 0.660 | 0.500         | 4.267                                 | 0.250    | 1.188 | 0.250    | 0.750  |       |       |       |       |       |
| 4.325-12 UNS   | 3.000     | 1.500 | 0.500         | 4.267                                 | 0.250    | 1.188 | 0.250    | 0.750  |       |       |       |       |       |
| 5.497-12 UNS   | 4.000     | 1.000 | 0.625         | 5.439                                 | 0.375    | 1.250 | 0.375    | 0.750  |       |       |       |       |       |

## Installation

### STEP TWO: Mount Front End of Wiper to the Screw

*If wiper is not included or integral to ball nut, then proceed to STEP THREE.*

#### Wipers

Wipers are available for most units as optional items. Precision inch ball nuts typically do not include wipers but they may be added as an option. Precision Plus inch ball nuts and all metric ball nuts include wipers as standard. Wipers generally fall into two categories: one style is internally mounted inside the extreme ends of the ball nut; the other is a wiper and retainer kit combination mounted on the exterior end of the ball nut. In some applications, one or the other may be used or a combination of both. Visual inspection will reveal the style used.

To obtain maximum service from a ball screw assembly, the ball nut should be protected from metal chips and dirt. Foreign material entering the ball nut may be rolled into the ball race, causing high localized loading, abrasion and spalling of the balls, resulting in premature failure. The wiper helps prohibit contaminants from entering the nut as it translates along the screw. These wipers are effective in most industrial applications.

For wipers with flange retainer: 1) Select end of screw to install ball nut (typically end with shortest journal length). 2) Orient ball nut with flange facing desired direction. 3) Install wiper holder and wiper for leading end of ball nut to ball screw. Then follow the ball nut installation procedure, STEP THREE, page 220. 4) Install wiper holder onto trailing end of ball nut once the ball nut is installed on the ball screw.



**Brush Wiper**

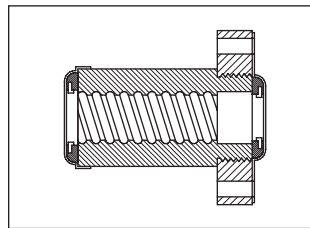

**Wiper with Flange Retainer**

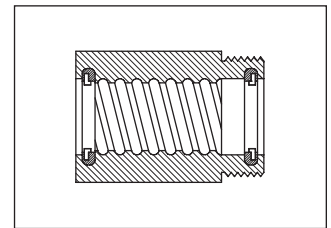

**Internal Snap Ring**

### Typical Methods of Attaching Wipers to V-Thread End

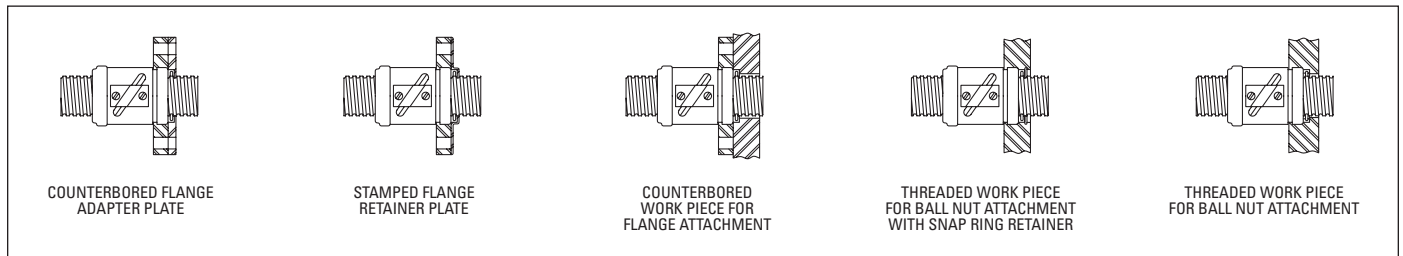

**Wiper without Flange Retainer**

## Installation

### STEP THREE: Install Ball Nut onto the Ball Screw

#### Installing Ball Nut onto Ball Screw

Each ball nut is completely assembled and loaded with bearing balls before it leaves the factory. The balls are held in place by a shipping arbor/mandrel.

**CAUTION:** If the arbor is removed without turning the nut onto the screw, the bearing balls will fall out of the nut and will require reloading.

**Method A:** Install Ball Nut without Preload onto Ball Screw

**Method B:** Install Ball Nut with Preload onto Ball Screw Using Gap Technique (required on part numbers listed in Table B)

**Method C:** Install Ball Nut with Preload onto Ball Screw Using Turn Technique (required on part numbers listed in Table C)

#### Method A: Install Ball Nut without Preload onto Ball Screw

To transfer the ball nut to the screw, proceed as follows:

1. Remove any ball nut retainer from the arbor. Hold the arbor firmly end to end with the screw. Make certain the arbor end is centered on the screw shaft end. (See Figure 3.)

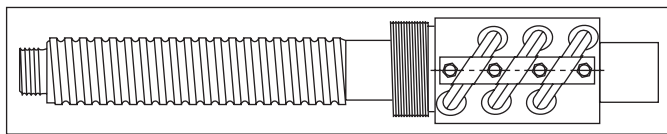

Figure 3

2. Slide the ball nut down to the screw shaft and rotate to the thread until you feel the balls drop into the screw thread. Then rotate with the screw thread until the ball nut completely clears the end of the screw shaft adjacent to the arbor. (See Figure 4.)

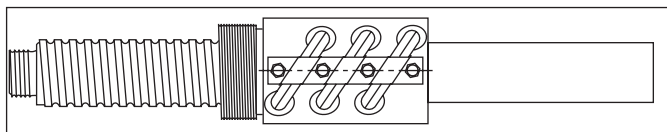

Figure 4

3. Remove the arbor. (See Figure 5.)

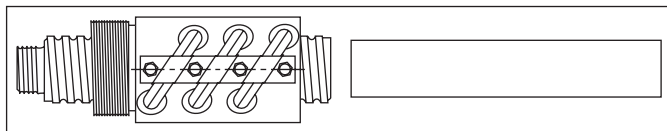

Figure 5

To transfer the ball nut to the arbor, reverse these steps.

**CAUTION:** When end machining makes it impossible to bring the arbor adjacent to the shaft ball grooves, wrap the machined portion with tape to the nominal O.D. of the arbor. The tape will permit the ball nut to slide over the machined area without the balls dropping into machined irregularities in the shaft.

**CAUTION:** Extreme care must be taken to prevent the ball nut from sliding off the end of the screw shaft during installation and handling. Temporary stops can be made by wrapping tape around the shaft ball grooves at each end. Be sure to remove the tape and any residual adhesive after the ball screw assembly is properly installed.

**Notes regarding installation of Preloaded Ball Nuts (Applicable to Methods B and C):**

#### Installing Preloaded Double Nut Preloaded Ball Screws (Double Nut Design)

General Description: The two primary reasons for preloading ball screws are to: eliminate backlash and obtain maximum system stiffness.

Preload for units having a compensating spring feature should be established in excess of the normal operating load whenever possible. Further adjustment is not normally required during the life expectancy. Units of this type are used in many specific applications requiring special considerations.

#### Transferring Ball Nuts from Arbor

Double nut design ball nuts are supplied on arbors. Care must be used not to lose any of the bearing balls, or trap balls between circuits when rotating the ball nut onto the screw.

#### Method B: Install Ball Nut with Preload onto Ball Screw Using Gap Technique (required on part numbers listed in Table B)

Use this procedure for assemblies having part numbers indicated in Table B.

#### Preloading Double Nuts Using Gap Technique

Ball nuts are transferred from arbor without a preload. Before preloading these ball nuts, oil the coupling threads, spring washers, ball nut bearing surfaces and the ball grooves of the screw shaft.

Be sure to keep the ball return tubes of the two ball nuts aligned (see Figure 6). Also, make sure the coupling tangs line up with the slots in the ball nut if they have become disengaged.

Position the ball nut midway on the screw shaft. Place retainers on screw to prevent the ball nut from accidentally running off the screw shaft. With the ball return tubes facing upwards, tighten the spanner nut against the spring washer "finger tight", plus 1/4 turn. Rotate the screw shaft through several turns in both directions while holding the ball nut with the ball return tubes on top. Continue to tighten the spanner nut with spanner or channel locks until the .003" (075mm) average gap is obtained resulting in the preload as indicated by the chart. Rotate the screw in both directions several times and check for smoothness. Be sure the spring washer of the coupling is centralized (not protruding in any direction). Use a plastic or brass mallet, if necessary, to help seat the coupling system. Tap lightly. Recheck torque and re-average gap as necessary.

Check the torque by rotating screw shaft with a torque wrench.

Secure the spanner nut with the set screw(s) provided.

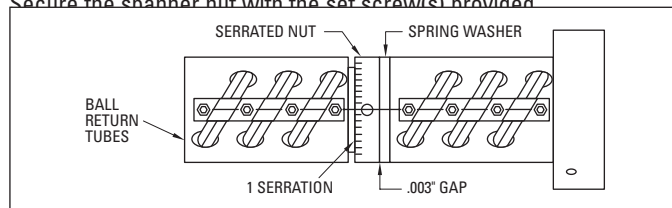

Figure 6

## Installation

**Table B. Preload Using Gap Technique**

| Ball Nut Nominal Size & Lead | Ball Nut P/N                           | Preload Lbs (Newtons) at .003" Gap | Torque In-Lbs (N-mm) at .003" Gap |
|------------------------------|--|------------------------------------|-----------------------------------|
| .500 x .500                  | 7826767                                | 150 (667)                          | 1.0 (113)                         |
| .631 x .200                  | 7820955 / 7820956<br>7823584           | 150 (667)                          | 1.0 (113)                         |
| .631 x 1.000                 | 7827531                                | 50 (222)                           | 50 (222)                          |
| .750 x .500                  | 7826991                                | 220 (979)                          | 1.5 (170)                         |
| .875 x .200                  | 7823585/7833677                        | 220 (979)                          | 1.5 (170)                         |
| 1.000 x .250                 | 5704167 / 5704168                      | 330 (1468)                         | 2.0 (226)                         |
| 1.000 x .250                 | 7820428                                | 330 (1468)                         | 2.0 (226)                         |
| 1.000 x .250                 | 7820426                                | 330 (1468)                         | 2.0 (226)                         |
| 1.000 x .250                 | 7823586                                | 330 (1468)                         | 2.0 (226)                         |
| 1.000 x 1.000                | 7829720                                | 330 (1468)                         | 2.0 (226)                         |
| 1.150 x .200                 | 5704270 / 7820206<br>7823587           | 240 (1068)                         | 1.5 (170)                         |
| 1.500 x .250                 | 5704271 / 7823588<br>7833234 / 5704573 | 920 (4092)                         | 5.5 (622)                         |
| 1.500 x 1.000                | 5700698                                | 1550 (6894)                        | 10.0 (1130)                       |
| 1.500 x 1.875                | 5704272                                | 1550 (6894)                        | 10.0 (1130)                       |
| 2.250 x .500                 | 7823589                                | 5000 (22240)                       | 30.0 (3390)                       |
| 2.500 x .250                 | 7823590                                | 1300 (5782)                        | 10.0 (1130)                       |
| 3.000 x .660                 | 5703045                                | 12400 (55155)                      | 75.0 (8475)                       |

### Method C: Install Ball Nut with Preload onto Ball Screw Using Turn Technique (required on part numbers listed in Table C)

Use this procedure for assemblies having part numbers indicated in Table C.

#### Preloading Double Nuts Using Turn Technique

Turn the locknut onto the V-threads of the rear nut until it shoulders against the nut (Figure 7). Do not tighten the set screws yet.

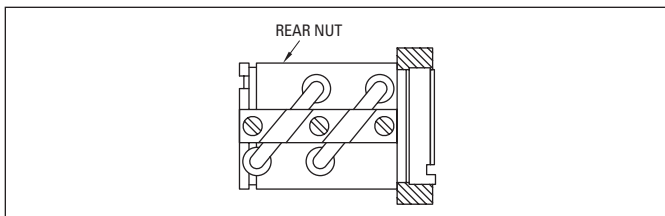

Figure 7. Assembly of locknut to rear nut.

Turn the front nut onto the screw as shown in Figure 10. Insert the tapered sleeve into position against the front nut with preload springs oriented as shown in Figure 8.

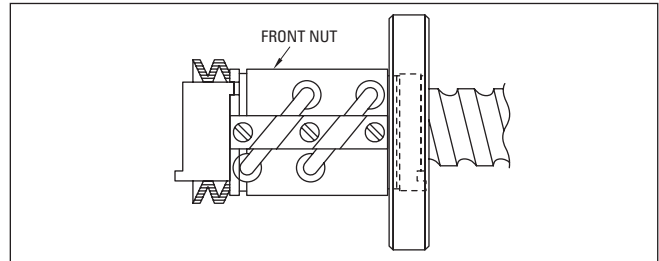

Figure 8. Preload spring orientation.

Insert the slots of the rear nut (lock nut end) into the tangs of the preload sleeve and turn the rear nut onto the screw. Both nuts now turn as an assembly with the tangs in full engagement to prevent the two nuts from rotating separately. The return tubes of the two nuts should be in line with one another. The adjuster nut must be loose at this point, not compressing the bellville springs. (See Figure 9.)

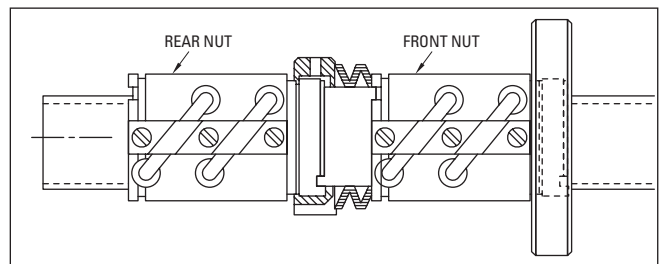

Figure 9. Assembly of rear nut to preload spring.

Hand turn the locknut until all freeplay is just removed. At this point, further turning will begin compressing the preload springs and begin to set the preload force.

#### Assembly

Transfer the front nut, with flange attached, onto the ball screw as shown in Figure 10. The nut should be turned onto the screw only far enough to avoid loss of bearing balls upon removing the mandrel.

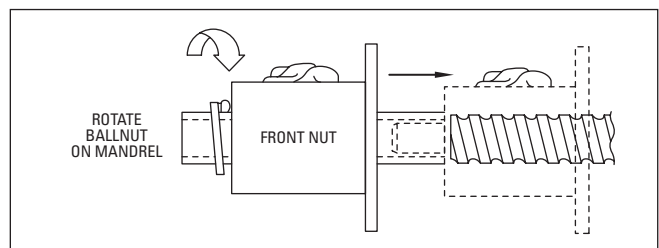

Figure 10. Transfer of front nut to screw.

## Installation

### Method C (Continued)

Bring the rear nut on its mandrel to position for turning onto the screw. (See Figure 11.)

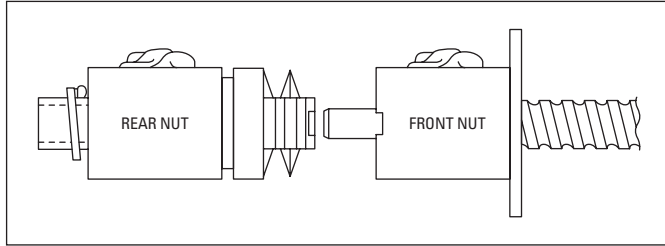

Figure 11. Positioning rear nut for mounting.

**NOTE:** Normally the rear nut for preloading is shipped fully assembled from the factory. If the spring package is not assembled to the rear nut as shown in Figure 12, review Preload Components Assembly for assembly instructions.

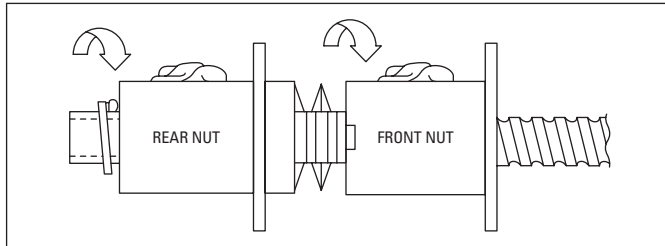

Figure 12. Mounting rear nut.

Insert the tabs of the preload sleeve into the slots of the front nut and then turn the rear nut onto the screw. Both nuts now turn as an assembly with the tangs in full engagement to prevent the two nuts from rotating separately. The return tubes of the two nuts should be in line with one another. The adjuster nut must be loose at this point, not compressing the belleville springs. (See Figure 13.)

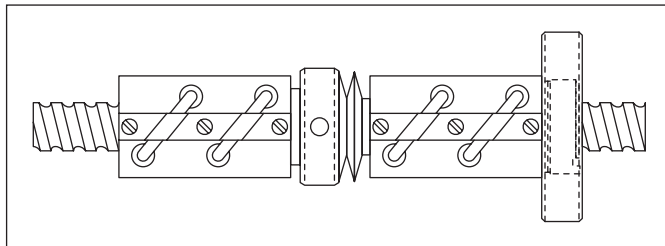

Figure 13. Assembled preload ready for setting.

Turn the locknut until all freeplay is just removed. At this point further turning will begin compressing the preload springs and set the preload force.

### Setting the Preload

#### Amount of Preload

Refer to Table C on page 223 for the number of turns, after freeplay is removed, required for the desired preload. The approximate preload per rotation is also given for preloads between recommended and maximum.

#### Methods of Setting the Preload

1. Small ball screws with light loads may often be set by hand-turning the adjuster nut to position while preventing rotation of the ball nuts.
2. Ball screws of medium size often require a spanner wrench to turn the adjuster nut to position.
3. Large size units sometimes require a spanner wrench with a pipe extension.

Rotation of the ball nuts during preload setting can be prevented by securing the flange in a fixture or installing the ball screw in its end use application.

**CAUTION:** Clamping the O.D. of the ball nuts in a vise or similar gripping system to prevent rotation during preload setting is unacceptable due to damage that may be caused to the balls or return tubes of the ball nut.

After setting the preload to the desired preload force, tighten the set screws into the adjuster nut to secure the preload setting.

#### Preload Components Assembly

Use in conjunction with Assembly instructions on page 221 if assembly of resilient preload components to rear nut is necessary.

Turn the locknut onto the V-threads of the rear nut until the spanner wrench holes line up with the pin holes on the nut. (See Figure 14.)

Do not tighten the set screws at this point.

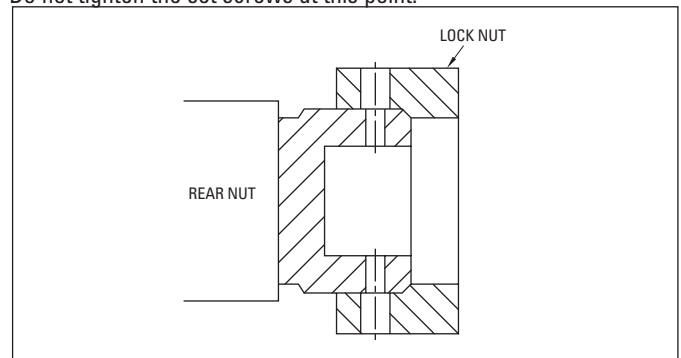

Figure 14. Assembly of locknut to rear nut.

## Installation

### Method C (Continued)

Insert the sleeve into position with preload springs oriented as shown in Figure 15. Align the sleeve holes for insertion of the spring pins.

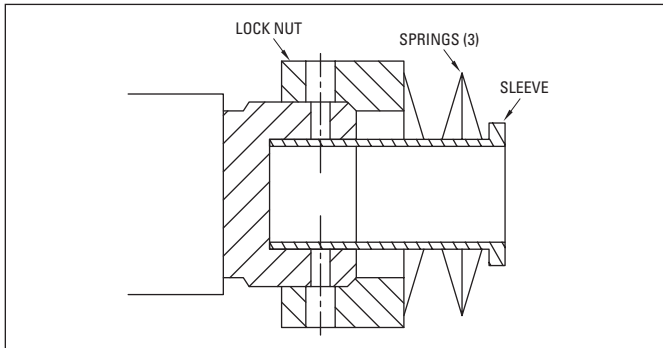

Figure 15. Assembly of sleeve and preload springs.

Press the pins to a depth just below the root of the V-threads in the locknut to allow the locknut to turn freely (see Figure 16). The pins must not be inserted deeper, as they may interfere with the ball screw grooves.

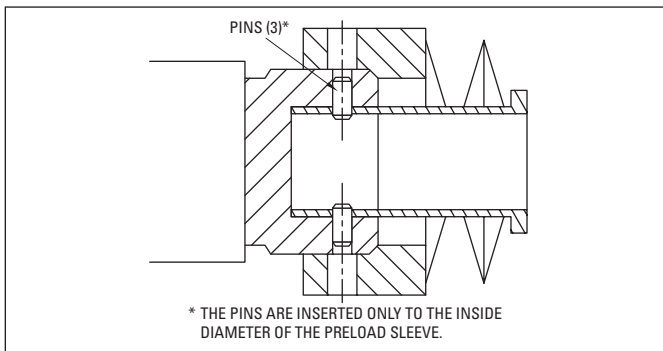

Figure 16. Inserting retainer pin.

Table C. Preload Using Turn Technique

| Ball Nut Nominal Size & Lead | Ball Nut P/N | Preload Lbs (Newtons) | Turns |
|------------------------------|--------------|-----------------------|-------|
| .375 x .125                  | 8103-448-004 | 50                    | 0.29  |
| .375 x .125                  | 8103-448-005 | 50                    | 0.29  |
| .500 x .200                  | 8105-448-008 | 120                   | 0.24  |
| .500 x .500                  | 8105-448-009 | 220                   | 0.46  |
| .500 x .500                  | 8105-448-012 | 190                   | 0.33  |
| .631 x .200                  | 8106-448-015 | 80                    | 0.25  |
| .631 x .200                  | 8106-448-019 | 80                    | 0.25  |
| .750 x .500                  | 8107-448-011 | 345                   | 0.58  |
| .750 x .200                  | 8107-448-012 | 190                   | 0.33  |
| .750 x .200                  | 8107-448-025 | 190                   | 0.33  |
| 1.000 x 1.000                | 8110-448-015 | 225                   | 0.43  |
| 1.000 x .500                 | 8110-448-016 | 395                   | 0.77  |
| 1.000 x .250                 | 8110-448-017 | 335                   | 0.64  |
| 1.000 x .250                 | 8110-448-018 | 335                   | 0.64  |
| 1.150 x .200                 | 8111-448-004 | 240                   | 0.59  |
| 1.500 x .500                 | 8115-448-006 | 1290                  | 0.65  |
| 1.500 x .500                 | 8115-448-007 | 1290                  | 0.65  |
| 1.500 x 1.000                | 8115-448-011 | 825                   | 0.49  |
| 1.500 x .250                 | 8115-448-012 | 405                   | 0.62  |
| 1.500 x .500                 | 8115-448-029 | 1290                  | 0.65  |
| 1.500 x 1.000                | 8115-448-032 | 825                   | 0.49  |
| 1.500 X 2.000                | 8115-448-059 | 760                   | 0.40  |
| 2.000 x .500                 | 8120-448-006 | 1915                  | 0.26  |
| 2.000 x .500                 | 8120-448-007 | 1915                  | 0.26  |
| 2.000 x 1.000                | 8120-448-019 | 2195                  | 0.30  |
| 2.250 x .500                 | 8122-448-003 | 1930                  | 0.51  |
| 2.250 x .500                 | 8122-448-008 | 1930                  | 0.51  |
| 2.500 x 1.000                | 8125-448-004 | 2690                  | 0.51  |
| 2.500 x .500                 | 8125-448-006 | 2120                  | 0.40  |
| 2.500 x .500                 | 8125-448-015 | 2120                  | 0.40  |
| 3.000 x .660                 | 8130-448-004 | 3800                  | 0.34  |
| 3.000 x .660                 | 8130-448-010 | 3800                  | 0.34  |

## Installation

### STEP FOUR: Complete Installation of the Wiper Kit

If applicable, complete wiper kit installation.

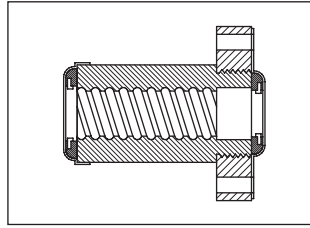

**Wiper with Flange Retainer**

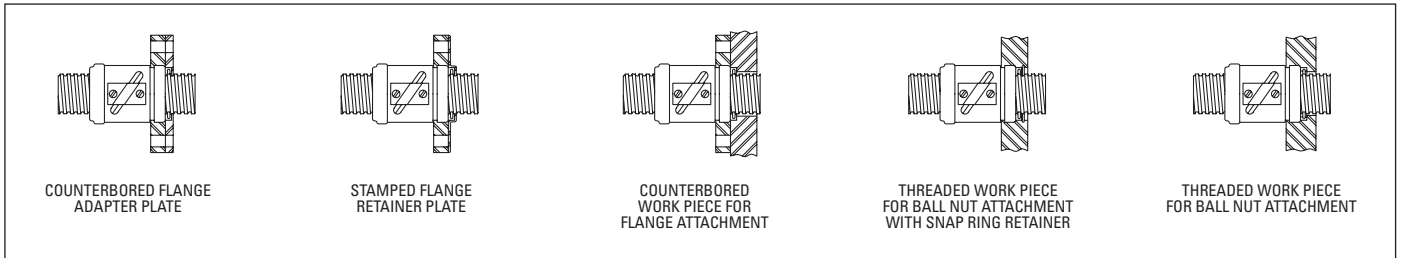

COUNTERBORED FLANGE  
ADAPTER PLATE

STAMPED FLANGE  
RETAINER PLATE

COUNTERBORED  
WORK PIECE FOR  
FLANGE ATTACHMENT

THREADED WORK PIECE  
FOR BALL NUT ATTACHMENT  
WITH SNAP RING RETAINER

THREADED WORK PIECE  
FOR BALL NUT ATTACHMENT

**Wiper without Flange Retainer**



## Installation

### STEP FIVE: Lubricate the Ball Nut and Screw

#### Lubrication

Ball screw components are coated with a light oil for shipping and storage and must be properly lubricated upon assembly.



We recommend using TriGEL-450R or TriGEL-1800RC for lubricating ball screws every 500,000 to 1 million inches of travel or every six months. Other lubricants may be applicable but have not been evaluated.

The TriGEL grease can be applied directly to the screw threads near the root of the ball track. Some ball nut sizes are available with threaded lube holes for mounting lubrication fittings. For these ball nuts, the TriGEL grease can be pumped directly into the nut. Please refer to the catalog to verify which ball nuts have the threaded lube holes. It is recommended to use these nuts in conjunction with a wiper kit to contain the lubricant within the body of the nut.

Ball screws may require lubrication more frequently than 500,000 inches depending on both environmental and operating conditions. If the lubricant appears to be dispersed before this point or has become dry or crusted, the maintenance interval should be reduced. Before adding additional lubrication, wipe the screw clean, removing the old grease and any particular contamination seen on the screw.

#### Initial Lubrication

As with ball bearings, ball screws can be lubricated using either oils, greases or solid lubricants. Oils are recommended for systems which operate at high speeds, in aggressive environments, or in high ambient temperatures. Greases are recommended for ball screws where an oil circulation lubrication system cannot be applied, or areas where a lubricated-for-life situation is possible. Solid lubricants are typically applied to adverse operating conditions where oils and greases are not suitable.

#### Grease Lubrication Quantity

The nut can be filled to as much as 70% but no lower than 30% of its free space, depending upon operating speed and nDm. Nuts which are not fitted with wipers can be filled completely.

#### Grease Relubrication

In general, ball screws should be relubricated every 500,000 revolutions or every six months. Ball screws which operate above 70°C should be relubricated more often (1/2 the relubrication period for every 15°C increment above 70°C). Use of synthetic lubricants can increase the relubrication interval up to four times, depending on formulation and operating conditions.

Relubrication quantities should equal 30% of the nut free space. When possible, relubrication should be performed while the screw is operating.

#### Run-In

In order to distribute the grease throughout the ball screw elements, it is recommended that the screw be run two to ten times over its complete operating stroke. Run-in should be performed at initial start-up and after every subsequent relubrication.

#### Grease Operating Life

When relubricated with the proper frequency, ball screws should achieve their rated fatigue life. When no relubrication is possible, actual grease operating life will be affected by operating speed, running temperature, and the extent of environmental contamination.

Relubrication intervals can best be determined by experience. Changes in grease consistency, grease color, operating torque and operating temperature can indicate the need for lubrication replenishment.

## Installation

### STEP SIX: Install Ball Screw Assembly into Your Machine

#### Installation of Ball Screw Assembly

A ball nut flange is the recommended means of attaching a ball nut to a load. The ball screw assembly should be mounted into a system or machine as shown in the figures below. Axial loading of the nut is optimal for performance and life and side loading installations or applications should be avoided.

Typical ball screw installations are combined with linear slides to provide support and guidance. Linear rails and ball screws must then be aligned parallel to prevent binding, increased system torque and a decrease in life. Typical installation practice consists of “floating” the ball screw or the linear rail into alignment. To “float” a screw into alignment, secure the linear rail into position and adjust the mounting blocks or nut to minimize the error from parallel.

#### Nut Loading

Axial loading (on nut or screw) is optimal for performance and life. For applications requiring radial loads, please contact us.

Axial Loading: optimal

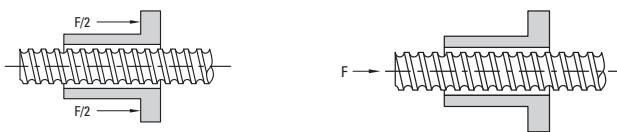

Radial Loading: detrimental\*



\* Minimize radial loading to less than 5% of the axial load.

#### Nut Mounting (Inch)

Use the following guidelines to achieve optimal performance.

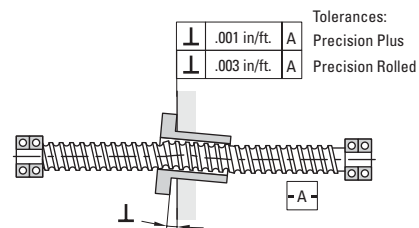
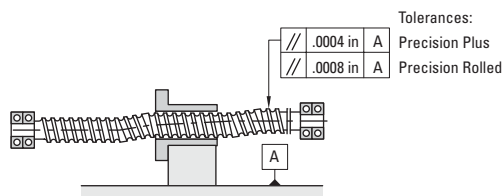

#### Nut Mounting (Metric)

Use the following guidelines to achieve optimal performance.  
(All units are mm)

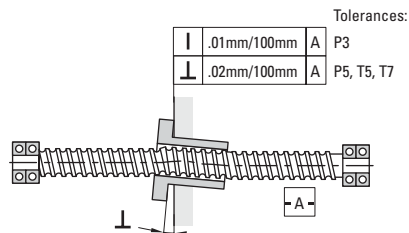
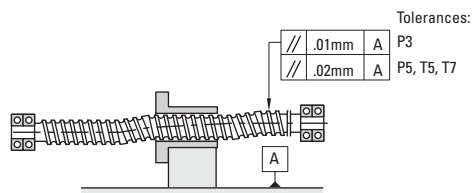

## Maintenance and Service

If proper attention is paid to ball bearing screw selection and installation, virtually no maintenance will be required except for routine lubrication.

All Thomson ball screw assemblies are designed for maximum life and trouble-free operation when adequately serviced and maintained. Ball screw disassembly should be attempted only after complying with the general inspection and maintenance instructions outlined in this section. Be positive that the ball screw is at fault. Disassembly should be done only by persons familiar with ball screw assembly principles. In any unusual circumstances, contact Thomson.

### Troubleshooting

Misalignment is one of the most common problems. Evidence of misalignment can generally be detected by one of the following situations:

- Squealing noise caused by the balls sliding in one or more of the circuits.
- Roughness in the form of vibrations or slightly erratic operation. This can normally be detected by “feel” when placing your hand on the return circuits.
- Excessive heat at the ball nut. Any appreciable temperature above the ambient of adjacent components should be considered excessive.

Gouging or scoring marks on the ball contact area of the screw may be caused by trapped balls between the circuits, broken balls, broken pick-up fingers or deflectors, or foreign objects which may have been digested by the ball nut.

When any of these conditions are encountered, examine the installation and, if necessary, immediately take corrective action to eliminate the cause and prevent further damage.

### General Inspection of the Screw Shaft

Inspect the shaft ball grooves for signs of excessive wear, pitting, gouges, corrosion, or brinelling. Normally, where any of these conditions exist on most Thomson Precision units, it may be more economical and advisable to replace the screw shaft.

### Backlash

Secure the screw shaft rigidly in a table clamp or similar device. Make sure it cannot rotate. Push firmly on the ball nut, first in one direction, then in the opposite direction. The axial movement of the ball nut is the backlash. This measurement can be taken with a dial indicator. Make sure that neither member rotates while the readings are taken.

Backlash with the following limits is considered acceptable:

| Ball Diameter  | Max. Permissible <sup>†</sup> Lash (used unit) | Max. Lash (new unit) |
|----------------|--|----------------------|
| 0 - 1/8"       | .008   | .005                 |
| 5/32" - 1/4"   | .014   | .007                 |
| 9/32" - 15/32" | .025   | .010                 |
| 1/2" and up    | .050   | .015                 |

<sup>†</sup> Values based on wear resulting from foreign material contamination and/or lack of lubrication.

If, after inspection, the screw shaft appears to be usable but has excessive backlash, proceed with further disassembly and component inspection.

### Disassembly

General Instructions: Have a clean container, such as a tote tray or cardboard box, handy for each ball return circuit of the ball nut assembly. A piece of clean cloth should be placed on the work table and gathered around the edge to form a pocket to retain the balls. Place the ball nut assembly over the cloth and remove the clamp.

Where more than one guide is held in place by a single clamp, secure each remaining guide with a strip of tape around the diameter of the ball nut to prevent accidental guide removal before you are ready for that circuit.

Remove both halves of the guide simultaneously to prevent distortion to either half. Catch all the balls from this circuit on the cloth by rotating the screw or ball nut slowly. Place the removed components into a container. Identify the container, the guide, and the circuit of the ball nut so the components can be reassembled in the same circuit from which they were removed. Repeat for each circuit.

## Maintenance and Service

### General Description

A Thomson ball screw is a force and motion transfer device belonging to the family of power transmission screws. It replaces sliding friction of the conventional power screw with the rolling friction of bearing balls. The balls circulate in hardened steel races formed by concave helical grooves in the screw and nut. All reactive loads between the screw and nut are carried by the balls which provide the only physical contact between these members.

As the screw and the nut rotate relative to each other, the balls are diverted from one end and carried by ball guides to the opposite end of the nut. This recirculation permits unrestricted travel of the nut in relation to the screw.

**Method I:** Ball nuts using a deflector return system are identified by threaded deflector studs extending through holes in the nut and the guide clamp. Lock nuts on the deflector studs are used to secure the clamps that hold the guides in place.

**Method II:** Ball nuts with pick-up fingers are identified by the finger projections integral with the guide. In this method, capscrew fasteners are used to fasten the clamp that holds the guide in place.

**Pick-up Finger Method:** Refer to the Component Inspection section.

**Deflector Method:** To remove the deflectors from the ball nut assembly, remove the ball nut from the screw shaft. The ball nut must be rotated since the deflectors engage loosely in the screw ball grooves and act as a thread. The deflectors now can be removed from the opposite ends of the ball nut so that you can use them for reference during component inspection.

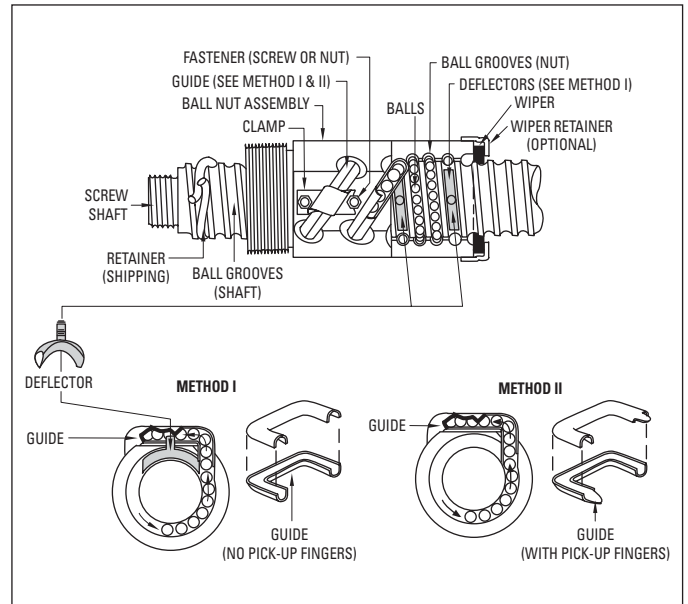

Figure 17

## Maintenance and Service

### Component Inspection and Replacement

**Balls:** If there is more than one circuit in the ball nut, count the balls in each of the separate containers to be sure each has the same number (within a variation of three balls). Check random samples (about 1/4 of the balls for a circuit) for the following:

- True roundness, with a .0001 in. maximum variation.
- Signs of scuffing or fish scaling.
- More than .0001 in. diameter variation between balls of the same circuit.

Where the random sampling shows balls out of round, signs of scuffing or variation of diameter in excess of .0001 in., or short count in any circuit, all balls in the unit must be replaced with a complete set of new balls. Ball kits are available from Thomson.

To ensure proper operation and long life of the serviced assembly, it is imperative that the diameters of all the replacement balls do not vary in excess of .00005 in. If Thomson kits are not used for service, make sure the balls meet the above specification. (Note: Use only chrome alloy steel balls, Grade 25 or better. Carburized balls or carbon steel balls will not provide adequate life.) See Ball Chart table.

**Deflectors:** Examine the ends of the deflectors for wear or brinelling. Wear can be determined by comparison with the unused ends of the two outside deflectors. Since these ends have not been subjected to wear from balls, they are in a like-new condition. Where wear or brinelling is evident, it is best to replace the deflectors with new ones.

**Pick-up Fingers:** Inspect the pick-up fingers, which consist of short extensions at the end of the guides. Replace with new guides if a ball brinell impression appears on the tip. Remove any burrs on the fingers. If the guides were distorted during removal, replace with new guides.

**Ball Nut:** Inspect the internal threads of the ball nut for signs of excessive wear, pitting, gouges, corrosion, spalling, or brinelling in the ball groove area. On large ball nuts, running the tip of your finger along the groove which is accessible will enable you to detect a secondary ridge in the ball groove area when wear is excessive or brinelling has occurred. (The extended lead of a mechanical pencil can also be used as a groove probe.) If inspection indicates any of these flaws, the ball nut assembly should be replaced.

**Wipers:** Prolonged use and environmental conditions will generally determine the condition of wipers. After cleaning wipers, reassemble over the screw shaft to determine whether a snug fit is maintained over the complete contour of the screw shaft. Any loose fitting or worn wipers should be replaced. Wiper kits are available from Thomson ball screws.

Note: If the assemblies have had extended use, it is recommended that all low cost items be replaced with new parts (i.e., balls, guides, deflectors, clamps). These can be ordered by simply referring to the assembly part number purchased.

### Reassembly

**Cleaning:** Clean all components with a commercial solvent and dry thoroughly before reassembly.

**Deflector Method:** Where the ball nut is equipped with deflectors, install these and secure temporarily by running the lock nuts down the studs and tightening.

**General Instructions:** Position the ball nut on the screw shaft. Ball nuts with deflectors have to be screwed on. Other ball nuts will slide on.

Using dowels with an O.D. approximately equal to the diameter of the balls, center the ball nut grooves with the shaft grooves by inserting dowels into each of the ball nut return circuit holes.

Remove the second dowel from one end. With the ball return holes up, fill the circuit with balls from the container corresponding to that circuit. Turning the screw in the ball nut will help to feed the balls into the groove. When the circuit is full, the balls will begin to lift the end dowel from its position. To be sure there are no voids, lightly tap the top bearing ball and see if the end dowel moves.

The remaining ball in the container should fit into one of the halves of the return guide with space for about three to six left.

Note: There must be some free space in the ball circuit so the balls will roll and not skid. Do not try to add extra balls into the circuit.

Place a dab of bearing grease at each end of the half return guide to hold the balls in place. Now, take the other half of the return guide and place it over the half guide you have filled with balls and insert two ends of the ball guide into the respective hole in the ball nut. Seat by tapping gently with a rawhide or plastic mallet.

Note: Where more than one ball circuit must be filled in the ball nut, tape the ball return circuit to the ball nut to prevent accidental removal. Repeat the filling procedure for the remaining circuits.

With all ball circuits filled and all return guides in place, secure the return guides with the retaining clamp.

**CAUTION:** Care should be taken to ensure that balls are not accidentally trapped between circuits in units having pick-up fingers. In deflector units, the deflectors will fill this space.

**Inspection:** Wrap tape around the ball grooves at the ends of the screw shaft to prevent the ball nut from rolling off. Now inspect the assembly for free movement of the ball nut along the entire stroke. There should be no binding, squeal, or roughness at any point.

**Reducing Backlash:** Backlash can be reduced by replacing all the balls with a larger size. If the diameters of the bearing balls are increased by .001 in., backlash is decreased by .003 in. (Ball kits are available for these applications.)

## Maintenance and Service

### Ball Chart (Grade 25 or Better)

| Size (Inches) | Part Number         | Nominal Diameter (Inches) | Number of Balls |
|---------------|---------------------|---------------------------|-----------------|
| .187 x .050   | <b>7821609</b>      | 0.039                     | 30              |
| .187 x .062   | <b>7821579</b>      | 0.039                     | 30              |
| .375 x .125   | <b>5709574</b>      | 0.063                     | 62              |
| .375 x .125   | <b>5709576</b>      | 0.063                     | 62              |
| .375 x .125   | <b>5709578</b>      | 0.063                     | 62              |
| .375 x .125   | <b>8103-448-017</b> | 0.078                     | 49              |
| .375 x .125   | <b>8103-448-018</b> | 0.078                     | 49              |
| .375 x .125   | <b>8103-448-003</b> | 0.078                     | 108             |
| .375 x .125   | <b>8103-448-013</b> | 0.078                     | 108             |
| .500 x .200   | <b>8105-448-013</b> | 0.125                     | 96              |
| .500 x .200   | <b>8105-448-008</b> | 0.125                     | 192             |
| .500 x .200   | <b>8105-448-023</b> | 0.125                     | 46              |
| .500 x .500   | <b>8105-448-014</b> | 0.125                     | 108             |
| .500 x .500   | <b>8105-448-011</b> | 0.125                     | 146             |
| .500 x .500   | <b>8105-448-016</b> | 0.125                     | 146             |
| .631 x .200   | <b>8106-448-022</b> | 0.125                     | 68              |
| .631 x .200   | <b>8106-448-026</b> | 0.125                     | 68              |
| .631 x .200   | <b>5707645</b>      | 0.125                     | 67              |
| .631 x .200   | <b>8106-448-009</b> | 0.125                     | 70              |
| .631 x .200   | <b>8106-448-008</b> | 0.125                     | 70              |
| .631 x .200   | <b>8106-448-036</b> | 0.125                     | 136             |
| .631 x .200   | <b>8106-448-012</b> | 0.125                     | 140             |
| .631 x .200   | <b>8106-448-015</b> | 0.125                     | 140             |
| .631 x .200   | <b>8106-448-019</b> | 0.125                     | 140             |
| .631 x .200   | <b>7832872</b>      | 0.138                     | 42              |
| .631 x 1.000  | <b>7826713</b>      | 0.125                     | 46              |
| .631 x 1.000  | <b>7827531</b>      | 0.125                     | 92              |
| .750 x .200   | <b>8107-448-018</b> | 0.125                     | 86              |
| .750 x .200   | <b>8107-448-026</b> | 0.125                     | 86              |
| .750 x .200   | <b>8107-448-016</b> | 0.125                     | 86              |
| .750 x .200   | <b>8107-448-027</b> | 0.125                     | 172             |
| .750 x .200   | <b>8107-448-046</b> | 0.125                     | 172             |
| .750 x .200   | <b>8107-448-025</b> | 0.125                     | 172             |
| .750 x .500   | <b>8107-448-014</b> | 0.156                     | 152             |
| .750 x .500   | <b>8107-448-020</b> | 0.156                     | 152             |
| .750 x .500   | <b>8107-448-049</b> | 0.156                     | 152             |
| .750 x .500   | <b>8107-448-048</b> | 0.156                     | 152             |
| .750 x .500   | <b>8107-448-011</b> | 0.156                     | 304             |
| .875 x .200   | <b>7833677</b>      | 0.125                     | 168             |
| .875 x .200   | <b>5708277</b>      | 0.125                     | 184             |
| 1.000 x .250  | <b>8110-448-091</b> | 0.156                     | 86              |
| 1.000 x .250  | <b>8110-448-055</b> | 0.156                     | 86              |
| 1.000 x .250  | <b>8110-448-032</b> | 0.156                     | 89              |
| 1.000 x .250  | <b>8110-448-030</b> | 0.156                     | 89              |
| 1.000 x .250  | <b>8110-448-056</b> | 0.156                     | 171             |
| 1.000 x .250  | <b>8110-448-026</b> | 0.156                     | 182             |
| 1.000 x .250  | <b>8110-448-024</b> | 0.156                     | 182             |
| 1.000 x .250  | <b>8110-448-087</b> | 0.156                     | 182             |
| 1.000 x .250  | <b>8110-448-088</b> | 0.156                     | 182             |
| 1.000 x .250  | <b>7820426</b>      | 0.156                     | 168             |
| 1.000 x .250  | <b>7820428</b>      | 0.156                     | 168             |
| 1.000 x .250  | <b>7823586</b>      | 0.156                     | 170             |
| 1.000 x .500  | <b>8110-448-022</b> | 0.156                     | 196             |
| 1.000 x .500  | <b>8110-448-016</b> | 0.156                     | 392             |
| 1.000 x 1.000 | <b>8110-448-086</b> | 0.156                     | 100             |
| 1.000 x 1.000 | <b>8110-448-020</b> | 0.156                     | 152             |
| 1.000 x 1.000 | <b>8110-448-034</b> | 0.156                     | 152             |

| Size (Inches) | Part Number              | Nominal Diameter (Inches) | Number of Balls |
|---------------|--------------------------|---------------------------|-----------------|
| 1.150 x .200  | <b>8111-448-006</b>      | 0.125                     | 252             |
| 1.150 x .200  | <b>7823587</b>           | 0.125                     | 224             |
| 1.150 x .200  | <b>8111-448-004</b>      | 0.125                     | 504             |
| 1.171 x .413  | <b>5707511</b>           | 0.281                     | 60              |
| 1.500 x .250  | <b>7833233</b>           | 0.156                     | 230             |
| 1.500 x .250  | <b>5701990</b>           | 0.156                     | 230             |
| 1.500 x .250  | <b>7833234</b>           | 0.156                     | 464             |
| 1.500 x .250  | <b>5704573</b>           | 0.156                     | 464             |
| 1.500 x .473  | <b>5707513</b>           | 0.344                     | 86              |
| 1.500 x .500  | <b>8115-448-016</b>      | 0.312                     | 140             |
| 1.500 x .500  | <b>8115-448-018</b>      | 0.312                     | 140             |
| 1.500 x .500  | <b>8115-448-006</b>      | 0.312                     | 280             |
| 1.500 x 1.000 | <b>5708280</b>           | 0.344                     | 60              |
| 1.500 x 1.000 | <b>5701995</b>           | 0.344                     | 60              |
| 1.500 x 1.000 | <b>7833724</b>           | 0.344                     | 60              |
| 1.500 x 1.000 | <b>8115-448-014</b>      | 0.344                     | 68              |
| 1.500 x 1.000 | <b>8115-448-049</b>      | 0.344                     | 68              |
| 1.500 x 1.000 | <b>5700698</b>           | 0.344                     | 120             |
| 1.500 x 1.000 | <b>8115-448-011</b>      | 0.344                     | 136             |
| 1.500 x 1.875 | <b>5707654</b>           | 0.281                     | 84              |
| 1.500 x 1.875 | <b>5704272</b>           | 0.281                     | 168             |
| 1.500 x 2.000 | <b>8115-448-056</b>      | 0.281                     | 96              |
| 1.500 x 2.000 | <b>8115-448-057</b>      | 0.281                     | 96              |
| 2.000 x .500  | <b>8120-448-011</b>      | 0.375                     | 150             |
| 2.000 x .500  | <b>8120-448-013</b>      | 0.375                     | 150             |
| 2.000 x .500  | <b>8120-448-006</b>      | 0.375                     | 300             |
| 2.000 x .500  | <b>8120-448-007</b>      | 0.375                     | 300             |
| 2.000 x 1.000 | <b>8120-448-021</b>      | 0.375                     | 160             |
| 2.000 x 1.000 | <b>8120-448-019</b>      | 0.375                     | 320             |
| 2.250 x .500  | <b>7833235</b>           | 0.375                     | 154             |
| 2.250 x 1.000 | <b>5704555</b>           | 0.375                     | 164             |
| 2.500 x .250  | <b>5703243</b>           | 0.156                     | 468             |
| 2.500 x .250  | <b>7823590</b>           | 0.156                     | 936             |
| 2.500 x .500  | <b>8125-448-010</b>      | 0.375                     | 184             |
| 2.500 x 1.000 | <b>8125-448-008</b>      | 0.375                     | 194             |
| 3.000 x .660  | <b>8130-448-007</b>      | 0.500                     | 180             |
| 3.000 x 1.500 | <b>5704986</b>           | 0.500                     | 166             |
| 4.000 x 1.000 | <b>5703258</b>           | 0.625                     | 186             |
| .375 x 3      | <b>5706900 / 7828127</b> | 0.156                     | 54              |
| .625 x 3      | <b>5707445 / 7828128</b> | 0.187                     | 60              |
| .625 x 6      | <b>5708943 / 7828129</b> | 0.187                     | 120             |
| 1.000 x 3     | <b>5707472 / 7828130</b> | 0.187                     | 78              |
| 1.000 x 6     | <b>5708944 / 7828131</b> | 0.187                     | 156             |
| 1.500 x 3     | <b>5707528 / 7828132</b> | 0.250                     | 84              |
| 1.500 x 6     | <b>5708945 / 7828133</b> | 0.250                     | 168             |
| 2.000 x 3     | <b>5707530 / 7828134</b> | 0.312                     | 72              |
| 2.000 x 6     | <b>5708946 / 7828135</b> | 0.312                     | 144             |
| 2.500 x 3     | <b>5707532 / 7828136</b> | 0.375                     | 66              |
| 2.500 x 6     | <b>5708947 / 7828137</b> | 0.375                     | 132             |
| 4.062 x 6     | <b>5708330 / 7828138</b> | 0.375                     | 180             |
| 6.000 x 8     | <b>5704798 / 7828140</b> | 0.500                     | 224             |

## Maintenance and Service

| Size (mm) | Part Number      | Nominal Diameter (mm) | Number of Balls |
|-----------|------------------|-----------------------|-----------------|
| 16 x 5    | 7832777          | 3.500                 | 42              |
| 20 x 5    | 7832780          | 3.500                 | 54              |
| 20 x 20   | 7832784          | 3.500                 | 100             |
| 25 x 5    | 7832787          | 3.500                 | 66              |
| 25 x 10   | 7832791          | 3.500                 | 164             |
| 25 x 25   | 7832794          | 3.500                 | 120             |
| 32 x 5    | 7832796          | 3.500                 | 116             |
| 32 x 10   | 7832799          | 5.556                 | 54              |
| 32 x 20   | 7832803          | 5.556                 | 136             |
| 32 x 32   | 7833300          | 3.969                 | 124             |
| 40 x 5    | 7832805          | 3.500                 | 180             |
| 40 x 10   | 7832809          | 7.144                 | 72              |
| 40 x 20   | 7832812          | 5.556                 | 156             |
| 40 x 40   | 7832815          | 7.144                 | 96              |
| 50 x 10   | 7832818          | 7.144                 | 88              |
| 50 x 20   | 7832821          | 6.350                 | 164             |
| 63 x 10   | 7832823          | 7.144                 | 140             |
| 63 x 20   | 7832826          | 7.144                 | 186             |
| 80 x 10   | 7832828          | 7.144                 | 210             |
| 16 x 5    | 7832835          | 3.500                 | 56              |
| 20 x 5    | 7832838          | 3.500                 | 108             |
| 25 x 5    | 7832841          | 3.500                 | 132             |
| 32 x 5    | 7832862          | 3.500                 | 232             |
| 32 x 10   | 7832844          | 5.500                 | 108             |
| 40 x 5    | 7832847          | 3.500                 | 360             |
| 40 x 10   | 7832850          | 6.350                 | 160             |
| 50 x 10   | 7832853          | 7.144                 | 176             |
| 63 x 10   | 7832856          | 7.144                 | 280             |
| 80 x 10   | 7832859          | 7.144                 | 420             |
| 12 x 10   | KGF-D-1210-RH-EE | 2.000                 | 63              |
| 16 x 5    | KGF-D-1605-RH-EE | 3.500                 | 45              |
| 16 x 10   | KGF-D-1610-RH-EE | 3.000                 | 102             |
| 20 x 5    | KGF-D-2005-RH-EE | 3.500                 | 48              |
| 25 x 5    | KGF-D-2505-RH-EE | 3.500                 | 63              |
| 25 x 10   | KGF-D-2510-RH-EE | 3.500                 | 75              |
| 25 x 20   | KGF-D-2520-RH-EE | 3.500                 | 80              |
| 25 x 25   | KGF-D-2525-RH-EE | 3.500                 | 130             |
| 25 x 50   | KGF-D-2550-RH-EE | 3.500                 | 130             |
| 32 x 5    | KGF-D-3205-RH-EE | 3.500                 | 140             |
| 32 x 10   | KGF-D-3210-RH-EE | 7.140                 | 42              |
| 32 x 20   | KGF-D-3220-RH-EE | 5.000                 | 84              |
| 32 x 32   | KGF-D-3232-RH-EE | 3.969                 | 124             |
| 40 x 5    | KGF-D-4005-RH-EE | 3.500                 | 180             |
| 40 x 10   | KGF-D-4010-RH-EE | 7.140                 | 54              |
| 40 x 20   | KGF-D-4020-RH-EE | 5.000                 | 104             |
| 40 x 40   | KGF-D-4040-RH-EE | 3.500                 | 360             |
| 50 x 10   | KGF-D-5010-RH-EE | 7.140                 | 115             |
| 50 x 20   | KGF-D-5020-RH-EE | 7.140                 | 100             |
| 63 x 10   | KGF-D-6310-RH-EE | 7.144                 | 140             |
| 63 x 20   | KGF-D-6320-RH-EE | 7.140                 | 96              |

| Size (mm) | Part Number      | Nominal Diameter (mm) | Number of Balls |
|-----------|------------------|-----------------------|-----------------|
| 16 x 5    | KGF-N-1605-RH-EE | 3.500                 | 45              |
| 20 x 5    | KGF-N-2005-RH-EE | 3.500                 | 48              |
| 20 x 20   | KGF-N-2020-RH-EE | 3.500                 | 100             |
| 20 x 50   | KGF-N-2050-RH-EE | 3.500                 | 140             |
| 25 x 5    | KGF-N-2505-RH-EE | 3.500                 | 63              |
| 32 x 5    | KGF-N-3205-RH-EE | 3.500                 | 140             |
| 32 x 10   | KGF-N-3210-RH-EE | 7.140                 | 42              |
| 32 x 40   | KGF-N-3240-RH-EE | 3.500                 | 168             |
| 40 x 5    | KGF-N-4005-RH-EE | 3.500                 | 180             |
| 40 x 10   | KGF-N-4010-RH-EE | 7.140                 | 54              |
| 50 x 10   | KGF-N-5010-RH-EE | 7.140                 | 115             |
| 63 x 10   | KGF-N-6310-RH-EE | 7.140                 | 140             |
| 80 x 10   | KGF-D-8010-RH-EE | 7.144                 | 175             |
| 12 x 10   | KGM-D-1210-RH-EE | 2.000                 | 63              |
| 16 x 5    | KGM-D-1605-RH-EE | 3.500                 | 45              |
| 16 x 10   | KGM-D-1610-RH-EE | 3.000                 | 102             |
| 20 x 5    | KGM-D-2005-RH-EE | 3.500                 | 48              |
| 25 x 5    | KGM-D-2505-RH-EE | 3.500                 | 63              |
| 25 x 10   | KGM-D-2510-RH-EE | 3.500                 | 75              |
| 25 x 20   | KGM-D-2520-RH-EE | 3.500                 | 80              |
| 25 x 25   | KGM-D-2525-RH-EE | 3.500                 | 130             |
| 25 x 50   | KGM-D-2550-RH-EE | 3.500                 | 130             |
| 32 x 5    | KGM-D-3205-RH-EE | 3.500                 | 140             |
| 40 x 5    | KGM-D-4005-RH-EE | 3.500                 | 180             |
| 40 x 10   | KGM-D-4010-RH-EE | 7.140                 | 54              |
| 40 x 20   | KGM-D-4020-RH-EE | 5.000                 | 104             |
| 40 x 40   | KGM-D-4040-RH-EE | 3.500                 | 360             |
| 50 x 10   | KGM-D-5010-RH-EE | 7.144                 | 155             |
| 63 x 10   | KGM-D-6310-RH-EE | 7.144                 | 140             |
| 63 x 20   | KGM-D-6320-RH-EE | 7.140                 | 96              |
| 12 x 5    | KGM-N-1205-RH-OO | 2.000                 | 60              |
| 20 x 5    | KGM-N-2005-RH-EE | 3.500                 | 48              |
| 20 x 20   | KGM-N-2020-RH-EE | 3.500                 | 100             |
| 20 x 50   | KGM-N-2050-RH-EE | 3.500                 | 140             |
| 25 x 5    | KGM-N-2505-RH-EE | 3.500                 | 63              |
| 32 x 5    | KGM-N-3205-RH-EE | 3.500                 | 140             |
| 32 x 10   | KGM-N-3210-RH-EE | 7.140                 | 42              |
| 32 x 20   | KGM-N-3220-RH-EE | 5.000                 | 84              |
| 32 x 40   | KGM-N-3240-RH-EE | 3.500                 | 168             |
| 40 x 5    | KGM-N-4005-RH-EE | 3.500                 | 180             |
| 50 x 10   | KGM-N-5010-RH-EE | 7.140                 | 115             |
| 50 x 20   | KGM-N-5020-RH-EE | 7.140                 | 100             |
| 63 x 10   | KGM-D-6310-RH-EE | 7.144                 | 140             |
| 80 x 10   | KGM-D-8010-RH-EE | 7.144                 | 175             |
| 12 x 4    | 7832771          | 1.984                 | 57              |
| 16 x 5    | 7832778          | 3.500                 | 56              |
| 20 x 5    | 7832781          | 3.500                 | 72              |
| 25 x 5    | 7832788          | 3.500                 | 110             |
| 25 x 10   | 7832792          | 3.500                 | 55              |
| 32 x 5    | 7832797          | 3.500                 | 145             |
| 32 x 10   | 7832800          | 5.556                 | 72              |
| 40 x 5    | 7832806          | 3.500                 | 180             |
| 40 x 10   | 7832810          | 7.144                 | 90              |
| 40 x 20   | 7833723          | 5.556                 | 80              |
| 50 x 10   | 7832819          | 7.144                 | 132             |
| 63 x 10   | 7832824          | 7.144                 | 168             |
| 80 x 10   | 7832829          | 7.144                 | 210             |

## Maintenance and Service

**Inspection and Existing Preload Check:** Whenever possible, the complete ball screw assembly should be removed from the machine prior to a thorough inspection. Preliminary screw inspection can be made while the unit is still in the machine. Preload can be determined by measuring movement of the nut in respect to the screw shaft. Clamp an indicator to the screw shaft with its probe resting on the face of the nut. Apply a load to the machine carriage in both directions. Be sure that the screw cannot rotate or move axially. Any measurable backlash between the ball nut and screw is an indication that preload does not exist. (See Figure 18.)

If no backlash exists, proceed further as outlined to determine whether proper preload remains in the unit. Existing preload,  $W_p$ , can be determined by measuring torque,  $T_p$ , using the following formula:

$$W_p = \frac{T_p}{.007}$$

where:  $W_p$  = Preload force, in lb.  
 $T_p$  = Torque, in lb-in. (due to preload only)

**Note:** The above check is to determine preload only, and does not take into account torque due to seal drag or operating load.

Torque can be measured by means of a spring scale mounted to any projection on the ball nut or by means of a lever or rod secured to the ball nut. In taking this measurement, be sure the exact lever arm distance is measured. (See Figure 18.) This measurement (inch) multiplied by the scale reading (lb.) equals  $T_p$  (torque lb-in.). Existing preload can now be determined using the above formula.

Preload adjustment of a Precision ball screw (Figure 18) requires no disassembly. Possible removal of the ball nut from the machine housing may be necessary to expose the adjusting nut.

**Disassembly:** If in doubt about disassembly of preloaded ball nuts, contact Thomson Application Engineering. If the unit is to be disassembled for general repair, follow the steps previously outlined in this section.

If being disassembled for preload adjustment, follow the guidelines except remove only one-half of the ball nut assembly to an arbor. If a standard arbor is not available, one can be made from a piece of shafting or tubing with a diameter approximately .005 inch less than the root diameter of the ball grooves in the screw shaft. Both halves of the ball nut will come apart as soon as the last ball in the nut is free of the grooves in the screw shaft. It is not necessary to remove the other half from the screw.

**Preload Adjustment:** The adjusting nut unit in Figure 18 can be adjusted to the desired preload with the use of additional shims. To make further adjustment, loosen the set screw lock located on the periphery of the lock nut. Use a spanner wrench to rotate the adjusting nut to the desired setting. Recheck the preload.

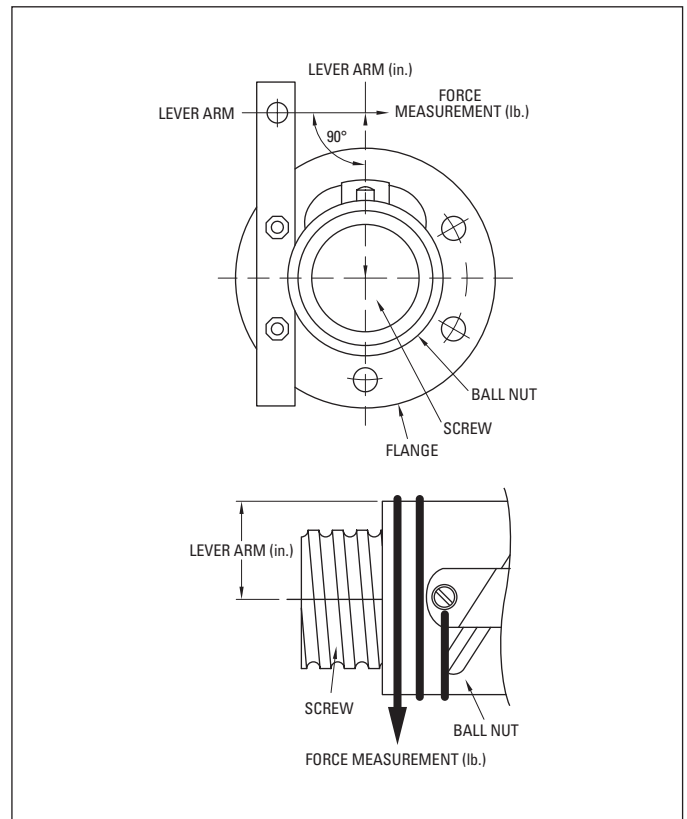

Figure 18

For all other standard units in Figure 18, a shim increase of .001 inch will, as a general rule, increase preload by 500 to 1,000 lb. This varies depending upon screw size; therefore, some judgement and trial and error may be necessary before the desired preload is achieved.

Preload force,  $W_p$ , can be determined by measuring torque,  $T_p$ , after the desired preload has been established using the following formula:

$$T_p = .007 \times W_p$$

where:  $T_p$  = torque, lb-in. (due to preload only)  
 $W_p$  = preload force, lb.

This section is intended to provide basic necessary information to properly service and maintain Thomson ball screws. Other forms of preloaded units may be encountered which have been designed for particular applications. Please contact Thomson Application Engineering for other specific information.



## Lubrication

### Guidelines

Ball screws must be lubricated to operate properly and achieve the rated life. We recommend using TriGEL-450R or TriGEL-1800RC for lubricating ball screws. Other oils and greases may be applicable but have not been evaluated.

The TriGEL® grease can be applied directly to the screw threads near the root of the ball track. Some ball nut sizes are available with threaded lube holes for mounting lubrication fittings. For these ball nuts, the TriGEL grease can be pumped directly into the nut. Please refer to the catalog detail views to verify which ball nuts have the threaded lube holes. It is recommended to use these nuts in conjunction with a wiper kit to contain the lubricant in the body of the nut.



### Lubrication

**Inspection Prior to Lubrication:** All ball screw assemblies should run smoothly throughout the entire stroke. If the torque is not uniform over the entire stroke:

- Visually inspect the screw shaft for accumulations of foreign matter.
- Using cleaning fluid or solvent, remove dirt from the ball grooves. Be sure to flush the ball nut assembly thoroughly.
- Cycle the ball nut along the screw shaft several times. Wipe with a dry, lintless cloth and lubricate immediately.
- If the assembly continues to operate erratically after cleaning, contact Thomson for further instructions.

**Lubrication:** The operating environment primarily determines the frequency and type of lubrication required by ball screws. The screw shaft should be inspected frequently and lubricated as required by the environmental conditions present. Lubricants can vary from instrument grade oil for dirty and heavy-dust environments to a good grade ball bearing grease for protected or clean environments. For most

applications, a good 10W30 oil periodically wiped on the screw shaft with a damp cloth or applied by a drip or mist lubricator will suffice.

**CAUTION:** Where the screw is unprotected from airborne dirt, dust, etc., do not leave a heavy film of lubricant on the screw. Keep the screw shaft barely damp with lubricant. Inspect at regular intervals to be certain lubricating film is present. Where the application requires operation at temperatures below 0° F, an instrument grade oil is recommended. Operating environments from 0° F to 180° F will require a good grade 10W30 oil. For assemblies with balls larger than 3/8 in. diameter, MIL G 3278 grease is recommended. Bearing grease is recommended for operating environments at nominally higher temperatures. Again, in unprotected conditions, the lubricant is best applied with a lubricant-dampened cloth, taking care not to leave an excessive film thickness on the screw. Ball screws should never be run dry.

### Lubrication Selection Chart for Ball & Lead Screw Assemblies

| Thomson Gel Type   | TriGel-300S                                | TriGel-450R                        | TriGel-600SM                       | TriGel-1200SC                                    | TriGel-1800RC   |
|--|--|------------------------------------|------------------------------------|--|---|
| Application  | Acme Screws<br>Supernuts, Plastic Nuts     | Ball Screws, Linear<br>Bearings    | Bronze Nuts                        | Acme Plastic Nuts,<br>Clean Room, High<br>Vacuum | Ball Screws, Linear<br>Bearings, Bronze Nuts,<br>Clean Room, Vacuum |
| Maximum Temperature*                                     | 200°C (392°F)                              | 125°C (257°F)                      | 125°C (257°F)                      | 250°C (482°F)                                    | 125°C (257°F)   |
| Mechanism Materials                                      | Plastic on Plastic or<br>Metal             | Metal on Metal                     | Metal on Metal<br>Bronze on Steel  | Plastic or Metals,<br>Combination                | Metal on Metal  |
| Mechanical Load  | Light                                      | Moderate                           | Moderate to Heavy                  | Light to Moderate                                | Moderate  |
| Very Low Torque Variation<br>over Temperature            | Yes  | —                                  | —                                  | Yes  | —   |
| Very Low Starting Torque                                 | Yes  | Yes                                | —                                  | Yes  | Yes   |
| Compatibility with<br>Reactive Chemicals                 | Not recommended w/o<br>OEM testing         | Not recommended w/o<br>OEM testing | Not recommended w/o<br>OEM testing | Usually OK                                       | Not recommended w/o<br>OEM testing                                  |
| Compatibility with Plastics<br>and Elastomers            | May cause silicon<br>rubber seals to swell | May cause EPDM seals<br>to swell   | May cause EPDM seals<br>to swell   | Usually OK                                       | May cause EPDM seals<br>to swell                                    |
| Clean Room Use   | Not recommended                            | Not recommended                    | Not recommended                    | Usually OK                                       | Usually OK  |
| High Vacuum Use  | Not recommended                            | Not recommended                    | Not recommended                    | Usually OK                                       | Usually OK  |
| Vapor Pressure (25°C)                                    | Varies with lot                            | Varies with lot                    | Varies with lot                    | 8x10 <sup>-3</sup> torr                          | 4x10 <sup>-3</sup> torr   |
| Order Number<br>10cc Syringe<br>1 Pound Tube<br>4oz Tube | TriGel-300S<br>TriGel-300S-1<br>NA         | TriGel-450R<br>TriGel-450R-1<br>NA | NA<br>NA<br>TriGel-600SM           | TriGel-1200SC<br>NA<br>NA                        | TriGel-1800RC<br>NA<br>NA   |

\* Maximum temperature for continuous exposure. Higher surge temperatures may be permissible but should be validated in the actual end use by the OEM. Low temperature limits are -15°C or lower. Consult Thomson for specifics.

## Glossary/Formulas

### Accuracy

A measurement of precision. Perfect accuracy, for example, means advancing a ball nut 1 in. from any point on a screw will always require the exact same number of revolutions.

### Annealed Ends

A manufacturing process which removes brittleness while softening screw stock to allow for machining of end journals.

### Arbor or Mandrel

Temporary shaft used to support ball nut during shipping assembly/disassembly.

### Axial Lash/Backlash

The axial free motion between the ball nut and ball screw; a measure of system stiffness and repeatability.

### Backdrive

Application of a force on a ball nut to cause rotation of the screw shaft; in essence, converting linear to rotary motion.

### Ball Bearing Spline

A linear motion device using the rolling contact principle. In a spline, the path of the bearings is parallel to the shaft to allow axial freedom and to provide torque transmitting capacity.

### Ball Circle Diameter

The distance between the centerlines of two exactly opposing recirculating balls when they are in contact with the screw. The basic point of reference used by Thomson when dealing with ball screws.

### Ball Nut

A nut compatible with a ball screw. The nut contains a series of bearing balls which are carried from one end of the nut to the other by a return tube.

### Ball Screw

A ball bearing screw is a screw that runs on bearing balls. The primary function of a ball bearing screw is to convert rotary motion to linear motion or torque to thrust.

### Bearing Ball Circuit

The closed path of recirculating balls within the ball nut assembly. A multiple circuits has a greater load carrying capability than a single circuit ball nut assembly of the same.

### Compression Load

Compression load is a load which would tend to compress or buckle the ball screw shaft.

### Conformity Ratio

Ratio of the ball track radius to the ball diameter.

### Contact Angle

Nominal angle between a plane perpendicular to the screw and a line drawn between a ball and the ball tracks and projected on a plane passing through the screw axis and the center of the ball. The angle at which the ball contacts the groove.

### Column Load

Column loading is the compression load on the screw. This load has a tendency to buckle the screw and is dependent on screw diameter, screw length and type of mounting.

### Critical Speed

The condition where the rotary speed of the assembly sets up harmonic vibrations. These vibrations are the result of shaft diameter, unsupported length, type of bearing support, ball nut mounting method, or the shaft or ball nut rpm. Vibrations may also be caused by a bent screw or faulty installation alignment.

### Cycle

The complete forward and reverse motion of the screw (or nut) when moving the load. One cycle is equivalent to two load carrying strokes (one forward and one backward).

### Diameter — Major

The outside diameter of the ball bearing screw shaft. In dealing with ball bearing screws, this is the basic measurement.

### Diameter — Minor (Root)

Diameter of the screw measured at the bottom of the ball track.

### Diameter — Pitch

The nominal diameter of a theoretical cylinder passing through the centers of the balls when they are in contact with the ball bearing screw and ball nut tracks.

### Driving Torque

The amount of effort, measured in pound-inches, required to turn the ball screw and move the load.

### Dynamic Load Rating

Dynamic load rating is the maximum load which a ball bearing screw assembly can maintain for 1.0 million inches of travel (Inch Series) or 1.0 million revolutions (Metric Series).

### Efficiency

Expressed as a percentage, the ability of a ball screw assembly to convert torque to thrust with minimal mechanical loss. Thomson ball screws operate at over 90% efficiency.

### End Bearing Support (End Fixity)

The three basic bearing configurations that are commonly used to support the ends of a ball screw are.

- a) A single journal or ball type bearing (simple support).
- b) A pair of back-to-back, angular contact bearings to control end play (simple support).
- c) A pair of spaced bearings for added rigidity (rigid support)

Four combinations of bearing supports are used throughout this catalog for selection purposes.

### Flange

A metal mounting plate attached to a ball nut.

### Gothic (or Ogival) Groove

A ball track cross-section shaped like a Gothic arch.

### Journal

1. A machined cylindrical surface.
2. End journals are machined ends of ball bearing screws which allow for bearing mounting.

### Land Area

The area on the outside diameter of a ball bearing screw between ball grooves.

### Lead

The axial distance a screw travels during one revolution.

### Lead Error

The amount of positional error per foot (Inch Series) or per 300mm (Metric Series) that is inherent in linear motion on ball screws.

## Glossary/Formulas

### Lead Tolerance

The maximum variation from nominal, measured in inches per foot, cumulative.

### Left (Right) Hand Threads

The direction of threads on a shaft or in a nut. Left hand means that the nut will move away if rotated counterclockwise. Right hand means the nut will move away if rotated clockwise.

### Linear Expansion

Ball screw and spline inner races have a coefficient of linear expansion of 0.0000065 for each degree of change (F) and for each inch of race length.

### Load Carrying Balls

The balls in contact with the ball grooves of both the nut and the screw for load carrying purposes.

### Load/Life Rating

The usable life of a ball bearing screw assembly measured in inches of travel under a specific load. The length of travel that 90 percent of a group of ball bearing screws will complete, or exceed, before the first evidence of fatigue develops.

### Lubrication

To provide the maximum useful life, ball splines and ball screws require lubrication. In general, standard ball bearing lubrication practices are acceptable.

### Off Center Load (Eccentric)

A load tending to cock the ball nut on the screw, reducing the rated life. This must be considered in the selection of the ball screw assembly.

### Operating Loads

The normal operating force in pounds (lb.) or Newtons (N) which the ball spline or ball screw will experience is considered the operating load. Contact us for assistance in applications subject to widely fluctuating loads or to optimize design.

### Preload

The use of one group of bearing balls set in opposition to another to remove axial lash or backlash and increase ball bearing screw stiffness. All axial backlash is eliminated in preloading.

### Protective Coatings

Standard outer races are supplied with a black oxide coating. Inner races are furnished with a phosphate coating. Contact Application Engineering for additional options.

### Repeatability

A measure of constancy that is directly related to axial backlash. Higher backlash equates to lower repeatability and may be corrected by preloading the ball nut if required.

### Root Diameter

The diameter of the screw shaft as measured at the bottom of the ball track.

### Screw Diameter (land diameter)

The outside diameter of the screw shaft.

### Screw Starts

The integral number of independent threads on the screw shaft; typically one, two, or four.

### Side Load (radial)

A load from the side that will reduce the rated life and must be considered in the selection of the ball bearing screw.

### Spring Rate

A ratio of load versus deflection of a component or of a total system. System stiffness will always be less than its most compliant member. Thus, in any system where a ball screw is used and where high system stiffness is a primary design requirement, Thomson should be contacted for recommendations based on the specifics of the application.

### Static Load

Static load is the maximum non-operating load capacity above which brinelling of the ball track occurs.

### Straightness

The linearity of a screw shaft. Precision screw stock is .010 in/ft. with .040 inch max. Precision Plus stock is typically .003 inch over the entire length of the screw.

### Stroke

The maximum length of extension of a ball nut on the screw shaft.

### Temperature (operating)

With suitable lubricants, ball splines and ball screws will operate with a minimum loss of efficiency between temperatures of -65° to +300°F (-53° to +149°C). Contact our application engineers for assistance in applications with extreme temperatures.

### Tension Load

Tension load is a load which would tend to stretch the ball screw shaft.

### Thrust Load

Thrust load is loading parallel to and concentric with the centerline of the screw shaft which acts continuously in one direction. Thrust loading is the proper method of attaching the load to the ball bearing screw assembly.

### Travel and Travel Rate

The distance a ball nut moves relative to the screw shaft. Travel rate is the distance traveled in a specific time period.

## Glossary/Formulas

### Some Useful Formulas for Ball Screw Assemblies

#### Torque, Rotary to Linear

Rotating the screw to translate the nut, or rotating the nut to translate the screw.

##### Ball Screw Assemblies

$$\text{Torque (in lbs)} = .177 \times \text{Load (lbs)} \times \text{Lead (inches)}$$

##### Lead Screw Assemblies

$$\text{Torque (in lbs)} = \frac{\text{Load (lbs)} \times \text{Lead (inches)}}{2\pi \times \text{efficiency}^*}$$

\* Acme screw efficiency is variable with the helix angle of the threads, the friction of the material and the finish. See the efficiency formula below.

#### Torque, Linear to Rotary

Translating the screw to rotate the nut, or translating the nut to rotate the screw.

##### Ball Screw Assemblies

$$\text{Torque (in lbs)} = .143 \times \text{Load (lbs)} \times \text{Lead (inches)}$$

##### Lead Screw Assemblies

$$\text{Torque (in lbs)} = \frac{\text{Load} \times \text{Lead} \times \text{Efficiency}}{2\pi}$$

The higher the lead of the screw the less effort required to backdrive either the screw or the nut.  
As a rule, the lead of the screw should be more than 1/3 the diameter of the screw to satisfactorily backdrive.

#### Efficiency

##### Ball Screw Assemblies

Most ball screw assemblies are better than 90% efficient.

##### Lead Screw Assemblies

$$\% \text{ Efficiency} = \frac{\tan(\text{helix angle})}{\tan(\text{helix angle} + \arctan f)} \times 100$$

f = coefficient of friction

#### Horsepower

##### Torque to Horsepower

$$\text{hp} = \frac{\text{Torque (in lbs)} \times \text{rpm}}{63,000}$$

##### Horsepower to Torque

$$\text{Torque} = \frac{63,000 \times \text{hp}}{\text{rpm}}$$

#### Column Load Strength\*

(Based on Eulers Formula)

$$P_{cr} = \frac{1.405 \times 10^7 \times F_c \times d^4}{L^2}$$

$P_{cr}$  = maximum loads (lbs)

$F_c$  = end support factor

.25 one end fixed, other free

1.00 both ends supported

2.00 one end fixed, other supported

4.00 both ends fixed

d = root diameter of screw (in.)

L = distance between nut and load carrying bearing (in.)

When possible, design for tension loads to eliminate the buckling factor and reduce the required screw size

#### Critical Screw Shaft Speed

(Maximum rotational speed of screw)

$$C_s = F_c \times 4.76 \times 10^6 \times \frac{d}{L^2}$$

$C_s$  = critical speed (rpm)

d = root diameter of screw (in.)

L = length between supports (in.)

$F_c$  = end support factor

.36 one end fixed, other free

1.00 both ends supported

1.47 one end fixed, other supported

2.23 both ends fixed

Critical shaft speed should be reduced to 80% to allow for other factors such as alignment and straightness

\* Formula only valid if  $L/d \geq 18.25$ .

**NOTES:**

A large grid of graph paper, consisting of 20 columns and 40 rows of small squares, intended for taking notes.



**NOTES:**

A large, empty grid of small squares, intended for taking notes. The grid covers most of the page area below the 'NOTES:' header.

## Custom Capabilities

### Thomson's Advantage

In addition to our extensive standard ball and lead screw products, Thomson has designed and manufactured custom engineered products to fit the unique requirements of our customers. We welcome and encourage requests for specialized products, regardless of quantity or frequency of order. Our custom products range from one-time-only units to high quantity requirements. A few of our custom possibilities are listed below:

### Custom Plastic Nuts

If cost or design constraints dictate a more integrated package, let our engineering staff help you simplify your design. We offer a full range of manufacturing capabilities from injection molding to CNC machining with the largest selection of engineering plastics to suit your applications and specifications.

- Our engineering staff will ensure your part is right the first time
- Full range of engineering plastics including internally lubricated and high temperature thermoplastics

### Precision Screw Products

Thomson provides engineering support and quality assurance for all of its components and assemblies allowing our customers to focus on the larger design picture. Our full range of designs and sizes for our linear motion components allow greater design flexibility, while our support staff ensures proper initial application and comprehensive support once installed.

### Components and Assemblies

From components to complete assemblies, Thomson always provides the highest performance products to your applications. Let us assist in your design to ensure proper operation of our components, or let us provide you a complete solution.

- Complete solutions to your linear motion designs with our industry tested assemblies
- Full complement of linear motion components: Rails (square and round), Motor Mounts, Bearing Mounts, Ball Nuts, Acme Plastic Nuts, Bronze Nuts, Anti-Backlash Nuts, Miniature Ball Nuts, Bearings, and more

If you don't see it, just ask us. Our application engineers will help you specify these options and modifications or they will work with you to create entirely new ones which will improve your machine's performance and lower your cost.

### Design Ranges

During our 65 plus years of servicing customers, our engineers have continuously developed new lead screw, ball screw, and spline assemblies required for many of industry's most unique, demanding applications. Our current product offering represents our evolving and expanding design and manufacturing capabilities.

The result of this experience is a portfolio of capabilities second to none. Thomson is the pioneer in the design and manufacture of:

- High speed ball screws – up to 300 in/min
- Telescoping assemblies – up to five sections
- Hollow shafting for low inertia and low weight
- Safety nuts with up to five redundant load paths
- Nylon nuts, offering extreme speeds and loads
- Ultimate accuracy assemblies – up to .0002 in/ft



## **USA, CANADA and MEXICO**

Thomson  
203A West Rock Road  
Radford, VA 24141, USA  
Phone: 1-540-633-3549  
Fax: 1-540-633-0294  
E-mail: [thomson@thomsonlinear.com](mailto:thomson@thomsonlinear.com)  
Literature: [literature.thomsonlinear.com](http://literature.thomsonlinear.com)

## **EUROPE**

### **United Kingdom**

Thomson  
Office 9, The Barns  
Caddsdow Business Park  
Bideford  
Devon, EX39 3BT  
Phone: +44 (0) 1271 334 500  
E-mail: [sales.uk@thomsonlinear.com](mailto:sales.uk@thomsonlinear.com)

### **Germany**

Thomson  
Nürtinger Straße 70  
72649 Wolfschlugen  
Phone: +49 (0) 7022 504 0  
Fax: +49 (0) 7022 504 405  
E-mail: [sales.germany@thomsonlinear.com](mailto:sales.germany@thomsonlinear.com)

### **France**

Thomson  
Phone: +33 (0) 243 50 03 30  
Fax: +33 (0) 243 50 03 39  
E-mail: [sales.france@thomsonlinear.com](mailto:sales.france@thomsonlinear.com)

### **Italy**

Thomson  
Largo Brughetti  
20030 Bovisio Masciago  
Phone: +39 0362 594260  
Fax: +39 0362 594263  
E-mail: [sales.italy@thomsonlinear.com](mailto:sales.italy@thomsonlinear.com)

### **Spain**

Thomson  
E-mail: [sales.esm@thomsonlinear.com](mailto:sales.esm@thomsonlinear.com)

### **Sweden**

Thomson  
Estridsväg 10  
29109 Kristianstad  
Phone: +46 (0) 44 24 67 00  
Fax: +46 (0) 44 24 40 85  
E-mail: [sales.scandinavia@thomsonlinear.com](mailto:sales.scandinavia@thomsonlinear.com)

## **ASIA**

### **Asia Pacific**

Thomson  
E-mail: [sales.apac@thomsonlinear.com](mailto:sales.apac@thomsonlinear.com)

### **China**

Thomson  
Rm 2205, Scitech Tower  
22 Jianguomen Wai Street  
Beijing 100004  
Phone: +86 400 6661 802  
Fax: +86 10 6515 0263  
E-mail: [sales.china@thomsonlinear.com](mailto:sales.china@thomsonlinear.com)

### **India**

Thomson  
c/o Fluke Technologies Pvt. Ltd.  
#424, Deodhar Center,  
Marol Maroshi Road,  
Andheri – E, Mumbai – 400059 India  
Phone: +91 22 29207641  
E-mail: [sales.india@thomsonlinear.com](mailto:sales.india@thomsonlinear.com)

### **Japan**

Thomson  
Minami-Kaneden 2-12-23, Suita  
Osaka 564-0044 Japan  
Phone: +81-6-6386-8001  
Fax: +81-6-6386-5022  
E-mail: [csjapan@scgap.com](mailto:csjapan@scgap.com)

### **Korea**

Thomson  
F7 Ilsong Bldg, 157-37  
Samsung-dong, Kangnam-gu,  
Seoul, Korea (135-090)  
Phone: +82 2 6917 5049  
Fax: +82 2 528 1456  
E-mail: [sales.korea@thomsonlinear.com](mailto:sales.korea@thomsonlinear.com)

## **SOUTH AMERICA**

### **Brazil**

Thomson  
Av. Tamboré, 1077  
Barueri, SP – 06460-000  
Phone: +55 (11) 3616-0191  
Fax: +55 (11) 3611-1982  
E-mail: [sales.brasil@thomsonlinear.com](mailto:sales.brasil@thomsonlinear.com)